

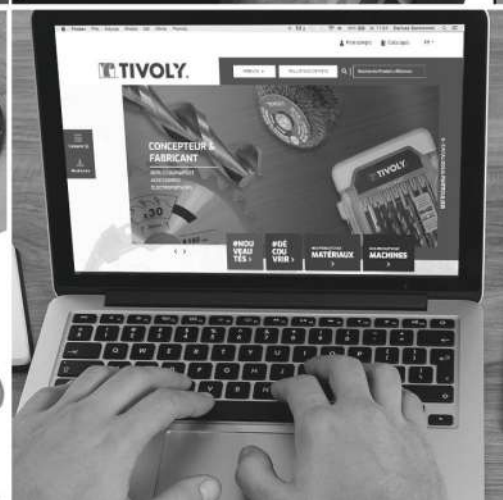

**TARIFA DIY | ACCESORIOS  
PARA HERRAMIENTAS  
ELECTROPORATIL**  
€ N° 01.2021\_V1

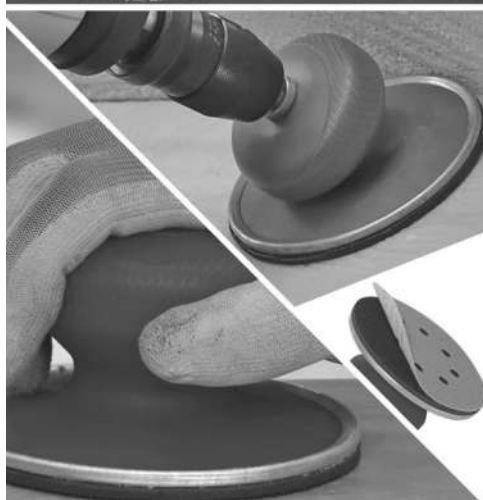
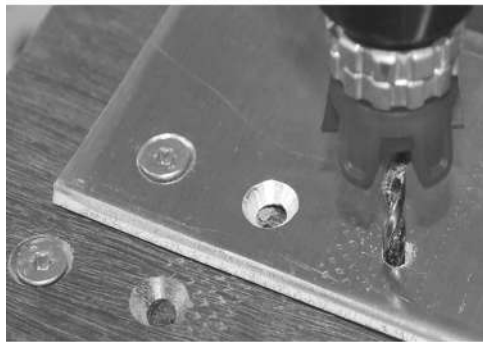

<b>TALADRADO .....</b>	<b>3</b>
Brocas Acero Rápido HSS para metal .....	3
Broca escalonada.....	10
Brocas de hormigón.....	12
Herramientas de demolición .....	19
Brocas de azulejo .....	21
Brocas multimaterial.....	22
Brocas de vidrio .....	23
Brocas de yeso.....	24
Brocas de madera.....	25
Accesorios para perforado.....	31
Composiciones de perforación mixtas .....	32
<b>MALETAS MIXTAS.....</b>	<b>33</b>
Maletas mixtas multiuniverso.....	33
<b>AFILADO.....</b>	<b>35</b>
DRILL DOCTOR & accesorios.....	35
Accesorios para afilado.....	36
<b>ROSCADO &amp; FILETEADO.....</b>	<b>37</b>
Machos Estándar .....	37
Accesorios para roscado .....	38
<b>ROSCADO.....</b>	<b>39</b>
Cojinetes .....	39
Accesorios / porta-cojinetes .....	40
<b>FRESADO .....</b>	<b>41</b>
Avellanador.....	41
Fresa rotativa.....	42
Composiciones de fresado mixtas.....	43
<b>ATORNILLADO .....</b>	<b>44</b>
Puntas de atornillado .....	44
Casquillos & Llaves de vaso.....	47
Composiciones mixtas para atornillar o apretar .....	49
Accesorios para atornillado.....	54
<b>CEPILLADO .....</b>	<b>57</b>
Cepillo a mano .....	57
Para taladro .....	58
Cepillo para amoladora angular .....	63
Para amoladora de banco.....	64
Composiciones mixtas para cepillado .....	65
<b>LIJADO.....</b>	<b>66</b>
Lijado a mano.....	66
Para lijadora .....	67

Lijado para amoladora angular.....	71
Lijado para taladro .....	73
Accesorios para lijado .....	75
<b>SERRADO .....</b>	<b>78</b>
Sierra cortadora Diamante .....	78
Sierra cortadora estándar .....	79
Trépanos.....	82
Otras sierras .....	83
Accesorios para serrado .....	84
Sierra caladora .....	85
Sierra de sable .....	88
Composiciones mixtas para serrado .....	89
Sierra circular .....	91
<b>TRONZADO .....</b>	<b>93</b>
Discos resinoides .....	93
Discos diamante.....	94
<b>REBAJADO .....</b>	<b>96</b>
Fresas de rebajadora.....	96
Composiciones mixtas para rebajadora .....	98
Accesorios para rebajadora .....	99
<b>ACCESORIOS.....</b>	<b>100</b>
Herramientas manuales.....	100
Portabrocas .....	102
Mezcladores .....	103
Ensamblajes .....	104
Escofinas .....	105
Cuchillas.....	106
Bombas .....	107

114685

Broca metal TECHNIC HSS E5 (cobalto 5%) (blíster)

1146852 Blister

Table with columns: CODE, EAN, Dim., PCB, Qty, € HT. Lists various drill bit specifications and prices.



Table with columns: CODE, EAN, Dim., PCB, Qty, € HT. Continuation of drill bit specifications and prices.

114531

TECHNIC STEAM TIN | Broca HSS TIN | Punta en cruz

1145312 Blister

Table with columns: CODE, EAN, Dim., PCB, Qty, € HT. Lists specifications and prices for cross-point HSS Tin drill bits.



1146854 Funda plástico

Table with columns: CODE, EAN, Dim., PCB, Qty, € HT. Lists specifications and prices for plastic packaging for drill bits.



114367

TSX | Broca HSS rectificada cilíndrica | Serie corta (blíster)

1143672 Blister

Table with columns: CODE, EAN, Dim., PCB, Qty, € HT. Lists specifications and prices for short cylindrical HSS ground drill bits.



114057

TECHNIC COBALT SL | Broca metal HSS E5 | Mango cilíndrico

1140572 Blister

Table with columns: CODE, EAN, Dim., PCB, Qty, € HT. Lists specifications and prices for Technic Cobalt SL drill bits with cylindrical handles.



114550

TC | Broca HSS E5 rectificada cilíndrica | Corta

1145504

Table with columns: CODE, EAN, Dim., PCB, Qty, € HT. Lists specifications and prices for short cylindrical HSS ground drill bits.





1143674 Funda plástico

Table with columns: CODE, EAN, Dim., PCB, Qty, € HT. Lists product details for 1143674 series.

Summary table for 1143784 with columns: CODE, EAN, Dim., PCB, Qty, € HT.

114378

T | Broca metal HSS | Mango reducido | Punta en cruz

1143784

Table with columns: CODE, EAN, Dim., PCB, Qty, € HT. Lists product details for 1143784 series.

114368

Broca HSS rectificada cilíndrica | Serie Corta | Mango reducido (blister)

1143682 Blister

Table with columns: CODE, EAN, Dim., PCB, Qty, € HT. Lists product details for 1143682 series.

1143684 Funda plástico

Table with columns: CODE, EAN, Dim., PCB, Qty, € HT. Lists product details for 1143684 series.

114343

TECHNIC | Broca HSS rectificada | Mango hexagonal

1143432 Blister

Table with columns: CODE, EAN, Dim., PCB, Qty, € HT. Lists product details for 1143432 series.

114377

T | Broca HSS rectificada cilíndrica. Serie corta | T LINE

1143774 Funda plástico

Table with columns: CODE, EAN, Dim., PCB, Qty, € HT. Lists product details for 1143774 series.

114370

EXTRACORTA | Broca HSS rectificada | Punta en cruz | Mango hexagonal

1143704 Funda plástico

Table with columns: CODE, EAN, Dim., PCB, Qty, € HT. Lists product details for 1143704 series.

502001

Broca HSS laminada cilíndrica | Serie corta | R

5020014 Funda plástico

Table with columns: CODE, EAN, Dim., PCB, Qty, € HT. Lists product details for 5020014 series.

CODE	EAN	Dim.	PCB	Qty	€ HT
50200140500	3221910025199	5	6	2	1,64
50200140550	3221910025205	5,5	6	1	1,21
50200140600	3221910025212	6	6	1	1,21
50200140650	3221910025229	6,5	6	1	1,41
50200140700	3221910025236	7	6	1	1,41
50200140750	3221910025243	7,5	6	1	1,50
50200140800	3221910025250	8	6	1	1,69
50200140850	3221910025267	8,5	6	1	1,69
50200140900	3221910025274	9	6	1	2,02
50200141000	3221910025298	10	6	1	2,29
50200141100	3221910025311	11	1	1	2,93
50200141200	3221910025335	12	1	1	3,45
50200141300	3221910025359	13	1	1	3,94



**502002 HSS broca metal laminada | Mango cilíndrico reducido**

5020024 Funda plástico

CODE	EAN	Dim.	PCB	Qty	€ HT
50200241400	3221910555900	14	1	1	9,88
50200241500	3221910555917	15	1	1	10,40
50200241600	3221910555924	16	1	1	11,55
50200241800	3221910555931	18	1	1	14,21
50200242000	3221910555948	20	1	1	18,07



**502003 Broca HSS laminada cilíndrica | Serie larga**

5020034 Funda plástico

CODE	EAN	Dim.	PCB	Qty	€ HT
50200340200	3221910555955	2	1	1	1,92
50200340250	3221910555962	2,5	1	1	2,16
50200340300	3221910555979	3	1	1	2,26
50200340350	3221910555986	3,5	1	1	2,51
50200340400	3221910555993	4	1	1	2,59
50200340450	3221910556006	4,5	1	1	2,59
50200340500	3221910556013	5	1	1	2,67
50200340550	3221910556020	5,5	1	1	2,73
50200340600	3221910556037	6	1	1	3,06
50200340800	3221910556051	8	1	1	5,09
50200341000	3221910556068	10	1	1	8,34
50200341200	3221910556075	12	1	1	11,60

**11468570001**

EAN : 3221912021403  
**10 brocas METAL graduadas de Ø1 a 10mm | TECHNIC COBALTO**

Ø1mm -2mm -3mm -4mm -5mm -6mm -7mm -8mm -9mm -10mm | Estuche Clipster

Pcs : 10 **68,45 €**

**11468570006**

EAN : 3221912112545  
**13 brocas METAL graduadas de Ø1,5 a 6,5mm | TECHNIC COBALTO**

Ø1,5mm -2mm -2,5mm -3mm -3,3mm -3,5mm -4mm -4,2mm -4,5mm -5mm -5,5mm -6mm -6,5mm | Estuche Clipster

Pcs : 13 **63,74 €**

**11468570015**

EAN : 3221912112347  
**19 brocas METAL graduadas de Ø1 a 10mm | TECHNIC COBALTO**

Ø1mm -1,5mm -2mm -2,5mm -3mm -3,5mm -4mm -4,5mm -5mm -5,5mm -6mm -6,5mm -7mm -7,5mm -8mm -8,5mm -9mm -9,5mm -10mm | Estuche E

Pcs : 19 **105,78 €**

**11455070015**

EAN : 3221912016522  
**19 brocas HSS E5 de Ø1 a 10mm por 1/2**

Ø1mm -1,5mm -2mm -2,5mm -3mm -3,5mm -4mm -4,5mm -5mm -5,5mm -6mm -6,5mm -7mm -7,5mm -8mm -8,5mm -9mm -9,5mm -10mm | Estuche E

Pcs : 19 **61,73 €**

**11455070017**

EAN : 3221912016539  
**25 brocas HSS E5 de Ø1 a 13mm por 1/2**

Ø1mm -1,5mm -2mm -2,5mm -3mm -3,5mm -4mm -4,5mm -5mm -5,5mm -6mm -6,5mm -7mm -7,5mm -8mm -8,5mm -9mm -9,5mm -10mm -10,5mm -11mm -11,5mm -12mm -12,5mm -13mm | Estuche G

Pcs : 25 **136,78 €**

**11468570003**

EAN : 3221912061317  
**5 brocas METAL graduadas de Ø1 a 3mm | TECHNIC COBALTO**

Ø1mm -1,5mm -2mm -2,5mm -3mm

Pcs : 5 **15,64 €**

**11468570002**

EAN : 3221912021397  
**6 brocas METAL graduadas de Ø1 a 8mm | TECHNIC COBALTO**

Ø2mm -3mm -4mm -5mm -6mm -8mm | Estuche Clipster

Pcs : 6 **33,82 €**

**11453170002**

EAN : 3221912072610  
**6 brocas METAL STEAM**  
**"TiN tip" de Ø2 a 8mm |**  
**TECHNIC**

Ø2mm -3mm -4mm -5mm -6mm  
 -8mm | Estuche Clipster

Pcs : 6

**19,18 €****11453170017**

EAN : 3221912092915  
**25 brocas METAL STEAM**  
**"TiN tip" de Ø1 a 13mm |**  
**TECHNIC**

Ø1mm -1,5mm -2mm -2,5mm -3mm  
 -3,5mm -4mm -4,5mm -5mm -5,5mm  
 -6mm -6,5mm -7mm -7,5mm -8mm  
 -8,5mm -9mm -9,5mm -10mm  
 -10,5mm -11mm -11,5mm -12mm  
 -12,5mm -13mm | Estuche G

Pcs : 25

**133,91 €****11453170001**

EAN : 3221912072603  
**10 brocas METAL STEAM**  
**"TiN tip" de Ø1 a 10mm |**  
**TECHNIC**

Ø1mm -2mm -3mm -4mm -5mm  
 -6mm -7mm -8mm -9mm -10mm |  
 Estuche Clipster

Pcs : 10

**39,47 €****11436770047**

EAN : 3221910050535  
**6 brocas metal de Ø2 a**  
**8mm**

Ø2mm -3mm -4mm -5mm -6mm  
 -8mm | Estuche Clipster

Pcs : 6

**15,76 €****11453170006**

EAN : 3221912205209  
**18 brocas HSS STEAM**  
**TiN de Ø2 a 10mm |**  
**TECHNIC**

Ø2mm -2,5mm -3mm -3,3mm -3,5mm  
 -4mm -4,2mm -4,5mm -5mm -5,5mm  
 -6mm -6,5mm -6,8mm -7mm -7,5mm  
 -8mm -8,5mm -9mm -9,5mm -10mm |  
 Estuche Ranger

Pcs : 18

**67,55 €****11436770049**

EAN : 3221910050559  
**10 brocas metal de Ø2 a**  
**10mm**

Ø1mm -2mm -3mm -4mm -5mm  
 -6mm -7mm -8mm -9mm -10mm |  
 Estuche Clipster

Pcs : 10

**32,41 €****11453170007**

EAN : 3221912205216  
**26 piezas: 25 brocas HSS**  
**STEAM TiN de Ø2 a**  
**10mm + 1 avellanador**  
**Ø15mm | TECHNIC**

Ø2mm -2,5mm -3mm -3,3mm -3,2mm  
 -3,5mm -4mm -4,2mm -4,5mm  
 -5mm -5,5mm -6mm -6,5mm  
 -6,8mm -7mm -7,5mm -8mm -8,5mm  
 -9mm -10mm -11mm -12mm -13mm +  
 1 avellanador Ø15mm | Estuche  
 Ranger

Pcs : 26

**120,05 €****11437770005**

EAN : 3221912072092  
**6 brocas METAL PRO de**  
**Ø2 a 8mm**

Ø2mm -3mm -4mm -5mm -6mm  
 -8mm | Estuche Clipster

Pcs : 6

**15,35 €****11453170015**

EAN : 3221912092892  
**19 brocas METAL STEAM**  
**"TiN tip" de Ø1 a 10mm |**  
**TECHNIC**

Ø1mm -1,5mm -2mm -2,5mm -3mm  
 -3,5mm -4mm -4,5mm -5mm -5,5mm  
 -6mm -6,5mm -7mm -7,5mm -8mm  
 -8,5mm -9mm -9,5mm -10mm |  
 Estuche E

Pcs : 19

**75,34 €****11437770004**

EAN : 3221912072085  
**10 brocas METAL PRO de**  
**Ø1 a 10mm**

Ø1mm -2mm -3mm -4mm -5mm  
 -6mm -7mm -8mm -9mm -10mm |  
 Estuche Clipster

Pcs : 10

**30,70 €**



**11437770003**

EAN : 3221912283337  
**13 brocas METAL PRO de  
 Ø1,5 a 6,5mm**

Ø1,5mm -2mm -2,5mm -3mm -3,3mm  
 -3,5mm -4mm -4,2mm -4,5mm -5mm  
 -5,5mm -6mm -6,5mm | Estuche  
 Clipster

Pcs : 13 **27,63 €**

**11452070010**

EAN : 3221912282149  
**Ø: / T | Broca HSS  
 rectificada cilíndrica.  
 Serie corta | T LINE / L:**

Pcs : 51 **79,34 €**

**11452070001**

EAN : 3221912205162  
**18 brocas HSS de Ø2 a  
 10mm**

Ø2mm -2,5mm -3mm -3,3mm -3,5mm  
 -4mm -4,2mm -4,5mm -5mm -5,5mm  
 -6mm -6,5mm -6,8mm -7mm -8mm  
 -8,5mm -9mm -10mm | Estuche  
 Ranger

Pcs : 18 **41,23 €**

**11452070011**

EAN : 3221912282156  
**Ø: / T | Broca HSS  
 rectificada cilíndrica.  
 Serie corta | T LINE / L:**

Pcs : 41 **184,48 €**

**11452070002**

EAN : 3221912205179  
**26 piezas: 25 brocas Ø2 a  
 13mm + 1 avellanador  
 escalonada Ø16,5mm**

Brocas acero rápido HSS Ø2mm  
 -2,5mm -3mm -3mm -3mm -3,3mm  
 -3,5mm -4mm -4mm -4,2mm -4,5mm  
 -5mm -5mm -5,5mm -6mm -6,5mm  
 -6,8mm -7mm -7,5mm -8mm -8,5mm  
 -9mm -10mm -11mm -12mm -13mm +  
 1 avellanador Ø16,5mm | Estuche  
 Ranger

Pcs : 26 **73,25 €**

**11452070003**

EAN : 3221912291103  
**Ø: / T | Broca HSS  
 rectificada cilíndrica.  
 Serie corta | T LINE / L:**

Pcs : 100 **109,00 €**

**11452070015**

EAN : 3221912016485  
**19 brocas HSS punta en  
 cruz de Ø1 a 10mm**

Ø1mm -1,5mm -2mm -2,5mm -3mm  
 -3,5mm -4mm -4,5mm -5mm -5,5mm  
 -6mm -6,5mm -7mm -7,5mm -8mm  
 -8,5mm -9mm -9,5mm -10mm |  
 Estuche E

Pcs : 19 **45,99 €**

**11434370002**

EAN : 3221912161703  
**5 brocas METAL mango  
 hexagonal SHOCK SERIE  
 de Ø2 a 6mm**

Ø2mm -3mm -4mm -5mm -6mm |  
 Estuche Clipster

Pcs : 5 **14,79 €**

**11452070017**

EAN : 3221912016492  
**25 brocas HSS punta en  
 cruz de Ø1 a 13mm**

Ø1mm -1,5mm -2mm -2,5mm -3mm  
 -3,5mm -4mm -4,5mm -5mm -5,5mm  
 -6mm -6,5mm -7mm -7,5mm -8mm  
 -8,5mm -9mm -9,5mm -10mm  
 -10,5mm -11mm -11,5mm -12mm  
 -12,5mm -13mm | Estuche G

Pcs : 25 **81,72 €**

**11434370001**

EAN : 3221910866594  
**5 brocas METAL mango  
 hexagonal de Ø2 a 6mm**

Ø2mm -3mm -4mm -5mm -6mm

Pcs : 5 **8,05 €**



**11437070002**

EAN : 3221912117496  
**6 brocas HSS mango hexagonal 1/4" de Ø3 a 10mm + 1 PP**

Brocas HSS mango hexagonal 1/4" Ø3mm -4mm -5mm -6mm -8mm -10mm + 1 portapuntas | Estuche FHX6

Pcs : 13

**43,27 €****90200170003**

EAN : 3221910104672  
**25 brocas HSS laminadas de Ø1 a 13mm por 1/2**

Ø1mm -1,5mm -2mm -2,5mm -3mm -3,5mm -4mm -4,5mm -5mm -5,5mm -6mm -6,5mm -7mm -7,5mm -8mm -8,5mm -9mm -9,5mm -10mm -10,5mm -11mm -11,5mm -12mm -12,5mm -13mm | Estuche G

Pcs : 25

**35,48 €****11437070001**

EAN : 3221910881580  
**12 brocas HSS mango hexagonal 1/4" de Ø3 a 10mm**

Ø3 -3,5mm -4mm -4,5mm -5mm -5,5mm -6mm -6,5mm -7mm -8mm -9mm -10mm | Estuche FHX12

Pcs : 12

**78,05 €****11437370001**

EAN : 3221912040190  
**19 piezas: 18 brocas metal TIN de Ø1 a 8mm + 1 broca escalonada**

Ø2mm -2,5mm -3mm -3mm -3,2mm -3,5mm -4mm -4mm -4,2mm -4,5mm -5mm -5mm -5,5mm -6mm -6,5mm -7mm -7,5mm -8mm + 1 broca escalonada Ø4 -12mm | Maletín

Pcs : 17

**37,07 €****11451070015**

EAN : 3221912016461  
**19 brocas HSS de Ø1 a 10mm por 1/2**

Ø1mm -1,5mm -2mm -2,5mm -3mm -3,5mm -4mm -4,5mm -5mm -5,5mm -6mm -6,5mm -7mm -7,5mm -8mm -8,5mm -9mm -9,5mm -10mm | Estuche E

Pcs : 19

**36,27 €****50200170010**

EAN : 3221910018023  
**6 brocas laminadas de Ø2 a 8mm**

2mm -3mm -4mm -5mm -6mm -8mm

Pcs : 6

**6,84 €****11451070017**

EAN : 3221912016478  
**25 brocas HSS punta en cruz de Ø1 a 13mm**

Ø1mm -1,5mm -2mm -2,5mm -3mm -3,5mm -4mm -4,5mm -5mm -5,5mm -6mm -6,5mm -7mm -7,5mm -8mm -8,5mm -9mm -9,5mm -10mm -10,5mm -11mm -11,5mm -12mm -12,5mm -13mm | Estuche G

Pcs : 25

**64,46 €****50200170008**

EAN : 3221910018047  
**13 brocas laminadas de Ø1,5 a 6,5mm**

Ø1,5mm -2mm -2,5mm -3mm -3,3mm -3,5mm -4mm -4,2mm -4,5mm -5mm -5,5mm -6mm -6,5mm

Pcs : 13

**10,68 €****90200170002**

EAN : 3221910104665  
**19 brocas laminadas de Ø1 a 10mm por 1/2**

Ø1mm -1,5mm -2mm -2,5mm -3mm -3,5mm -4mm -4,5mm -5mm -5,5mm -6mm -6,5mm -7mm -7,5mm -8mm -8,5mm -9mm -9,5mm -10mm | Estuche E

Pcs : 19

**18,15 €****50200170009**

EAN : 3221910018009  
**19 brocas laminadas de Ø1 a 10mm**

Ø1mm -1,5mm -2mm -2,5mm -3mm -3,5mm -4mm -4,5mm -5mm -5,5mm -6mm -6,5mm -7mm -7,5mm -8mm -8,5mm -9mm -9,5mm -10mm

Pcs : 19

**21,13 €**

**50200170005**

EAN : 3221910850845  
**13 brocas laminadas de  
 Ø1,5 a 6,5mm**

Ø1,5mm -2mm -2,5mm -3mm -3,3mm  
 -3,5mm -4mm -4,2mm -4,5mm -5mm  
 -5,5mm -6mm -6,5mm

Pcs : 13 **14,56 €**

**50200170011**

EAN : 3221910847913  
**14 brocas TiN Ø1,5 a  
 6,5mm + broca fresadora  
 (blíster)**

Ø1mm -1,5mm -2mm -2,5mm -3mm  
 -3,5mm -4mm -4,5mm -5mm -5,5mm  
 -6mm -6,5mm + 1 broca fresadora

Pcs : 14 **11,11 €**

**11300470015**

EAN : 3221912112323  
**Estuche | E VACÍO | Para  
 brocas de Ø1 a 10mm por  
 1/2mm**

Ø1mm -1,5mm -2mm -2,5mm -3mm  
 -3,5mm -4mm -4,5mm -5mm -5,5mm  
 -6mm -6,5mm -7mm -7,5mm -8mm  
 -8,5mm -9mm -9,5mm -10mm

Pcs : 1 **12,57 €**

**11300470017**

EAN : 3221912112330  
**Estuche | G VACÍO | Para  
 brocas de Ø1 a 13mm por  
 1/2mm**

Ø1mm -1,5mm -2mm -2,5mm -3mm  
 -3,5mm -4mm -4,5mm -5mm -5,5mm  
 -6mm -6,5mm -7mm -7,5mm -8mm  
 -8,5mm -9mm -9,5mm -10mm  
 -10,5mm -11mm -11,5mm -12mm  
 -12,5mm -13mm

Pcs : 1 **19,38 €**

114487 

**Broca HSS E5 TIALN cónica escalonada TIALN | Canal helicoidal**

└─ **1144872** Blister

CODE	EAN	Dim.	PCB	Qty	€ HT
11448720412	3221910843250	4=>12	1	1	70,40
11448720420	3221910843267	4=>20	1	1	89,91
11448720430	3221910843274	4=>30	1	1	155,56
11448720637	3221910843281	6=>37	1	1	246,85



114387 

**HI PERFJ Broca HSS escalonada TIALN | Canal helicoidal.**

└─ **1143872** Blister

CODE	EAN	Dim.	PCB	Qty	€ HT
11438720412	3221910223083	4=>12	1	1	50,28
11438720420	3221910223090	4=>20	1	1	64,22
11438720430	3221910223106	4=>30	1	1	111,10
11438720637	3221910223113	6=>37	1	1	176,31



114485 

**Broca HSS escalonada | Canal helicoidal (blister)**

└─ **1144852** Blister

CODE	EAN	Dim.	PCB	Qty	€ HT
11448520412	3221910899134	4=>12	1	1	35,49
11448520420	3221910899141	4=>20	1	1	45,33
11448520430	3221910899158	4=>30	1	1	65,67
11448520637	3221910899165	6=>37	1	1	104,22



114486 

**Broca HSS escalonada. Canal recto | T LINE**

└─ **1144862** Blister

CODE	EAN	Dim.	PCB	Qty	€ HT
11448620412	3221910856533	4=>12	1	1	26,13
11448620420	3221910856540	4=>20	1	1	34,46
11448620430	3221910856557	4=>30	1	1	58,47
11448620637	3221910856564	6=>37	1	1	83,08



114386 

**Broca HSS | Cónica lisa | Ampli. Orificio**

└─ **1143862** Blister

CODE	EAN	Dim.	PCB	Qty	€ HT
11438620314	3221910223038	3=>14	1	1	20,18
11438620520	3221910223045	5=>20	1	1	29,08
11438620531	3221910223052	5=>31	1	1	65,06
11438621630	3221910223069	16=>30,5	1	1	48,56
11438622440	3221910223076	24=>40	1	1	85,63



XT6021 

**Broca HSS escalonada | Mango cilíndrico | T LINE**

└─ **XT60212** Blister

CODE	EAN	Dim.	PCB	Qty	€ HT
XT60672000634	3128820006341	6=>20	1	1	34,08



**11448770001**

EAN : 3221910843298  
**3 brocas escalonadas HSS Cobalto TiAIN de Ø4 a 30mm**

Ø4>12mm -4>20mm -4>30mm | Estuche FCE430

Pcs : 3 **318,08 €**



**11448770002**

EAN : 3221910843304  
**4 brocas escalonadas HSS Cobalto TiAIN de Ø4 a 37mm**

Ø4>12mm -4>20mm -6>37mm | Estuche FCE637

Pcs : 3 **401,75 €**



**11438770001**

EAN : 3221910285937  
**3 brocas escalonadas HSS TiAIN de Ø4 a 30mm**

Ø4>12mm -4>20mm -4>30mm | Estuche FCE430

Pcs : 3 **226,73 €**



**11438770002**

EAN : 3221910780517  
**4 brocas escalonadas HSS TiAIN de Ø4 a 37mm**

Ø4>12mm -4>20mm -6>37mm | Estuche FCE637

Pcs : 3 **302,06 €**



**11448570001**

EAN : 3221912280435  
**3 brocas cónicas escalonadas HSS de Ø4 a 30mm | Canal helicoidal**

Ø4>12mm -4>20mm -4>30mm

Pcs : 3 **146,49 €**

**11448670001**

EAN : 3221912280442  
**3 brocas cónicas HSS de  
Ø4 a 30mm**

Ø4>12mm -4>20mm -4>30mm

Pcs : 3 **118,99 €**

**11438670001**

EAN : 3221912056566  
**3 brocas cónicas HSS de  
Ø3 a 30,5mm**

Ø3>14mm -5>20mm -16>30,5mm |  
Estuche FCL330

Pcs : 3 **120,99 €**



**109227**  **TECHNIC MASTER 3 | Broca hormigón 3 cortes | L110 | Mango SDS+**

**1092273** Enganche SDS

CODE	EAN	Dim.	PCB	Qty	€ HT
10922730500	3221910896508	5,00 /L 110x   50	1	1	8,11
10922730600	3221910896515	6,00 /L 110x   50	1	1	8,13
10922730800	3221910896522	8,00 /L 110x   50	1	1	10,25
10922731000	3221910896539	10,00 /L 110x   50	1	1	11,58

**109228**  **TECHNIC MASTER 3 | Broca hormigón 3 cortes | L160 | Mango SDS+**

**1092283** Enganche SDS

CODE	EAN	Dim.	PCB	Qty	€ HT
10922830500	3221910896546	5,00 /L 160x   100	1	1	8,86
10922830600	3221910896553	6,00 /L 160x   100	1	1	8,92
10922830800	3221910896560	8,00 /L 160x   100	1	1	10,59
10922831000	3221910896577	10,00 /L 160x   100	1	1	12,59
10922831200	3221910896584	12,00 /L 160x   100	1	1	15,65
10922831400	3221910896591	14,00 /L 160x   100	1	1	19,05

**109229**  **TECHNIC MASTER 3 | Broca hormigón 3 cortes | L200 | Mango SDS+**

**1092293** Enganche SDS

CODE	EAN	Dim.	PCB	Qty	€ HT
10922930600	3221910896607	6,00 /L 200x   150	1	1	11,84
10922930650	3221912087010	6,50 /L 200x   150	1	1	13,73
10922930800	3221910896614	8,00 /L 200x   150	1	1	12,80
10922931000	3221910896621	10,00 /L 200x   150	1	1	15,10
10922931200	3221910896638	12,00 /L 200x   150	1	1	18,57
10922931400	3221910896645	14,00 /L 200x   150	1	1	23,95

**109230**  **TECHNIC MASTER 3 | Broca hormigón 3 cortes | L250 | Mango SDS+**

**1092303** Enganche SDS

CODE	EAN	Dim.	PCB	Qty	€ HT
10923030800	3221910896652	8,00 /L 250x   200	1	1	13,81
10923031000	3221910896669	10,00 /L 250x   200	1	1	17,74
10923031200	3221910896676	12,00 /L 250x   200	1	1	20,31
10923031400	3221910896683	14,00 /L 250x   200	1	1	29,16
10923031600	3221912071897	16,00 /L 250x   200	1	1	36,67
10923031800	3221912071903	18,00 /L 300x   250	1	1	49,25
10923032000	3221912071910	20,00 /L 300x   250	1	1	53,44
10923032200	3221912071927	22,00 /L 300x   250	1	1	57,63

**109241**  **TECHNIC MASTER 3 | Broca hormigón 3 cortes | L310 | Mango SDS+**

**1092413** Enganche SDS

CODE	EAN	Dim.	PCB	Qty	€ HT
10924130650	3221912250117	6,5 L290x230	1	1	21,16
10924130800	3221912250124	8 L310x250	1	1	21,68
10924131000	3221912250131	10 L310x250	1	1	22,71
10924131200	3221912250148	12 L310x250	1	1	25,29
10924131400	3221912250155	14 L300x250	1	1	35,10
10924131600	3221912250162	16 L310x250	1	1	45,42

**109239**  **TECHNIC MASTER 3 | Broca hormigón 3 cortes | L450 | Mango SDS+**

**1092393** Enganche SDS

CODE	EAN	Dim.	PCB	Qty	€ HT
10923930800	3221912071934	8,00 /L 450x   400	1	1	38,25
10923931000	3221912071941	10,00 /L 450x   400	1	1	38,77
10923931200	3221912071965	12,00 /L 450x   400	1	1	38,77

CODE	EAN	Dim.	PCB	Qty	€ HT
10923931400	3221912071972	14,00 /L 450x   400	1	1	44,01
10923931600	3221912071989	16,00 /L 450x   400	1	1	55,01
10923931800	3221912071996	18,00 /L 450x   400	1	1	67,05
10923932000	3221912072009	20,00 /L 450x   400	1	1	74,39
10923932200	3221912072016	22,00 /L 450x   400	1	1	86,96
10923932500	3221912072023	25,00 /L 450x   400	1	1	98,49

**109242**  **TECHNIC MASTER 3 | Broca hormigón 3 cortes | L600 | Mango SDS+**

**1092423** Enganche SDS

CODE	EAN	Dim.	PCB	Qty	€ HT
10924231000	3221912250179	10 L600x550	1	1	55,22
10924231200	3221912250186	12 L600x550	1	1	56,78
10924231400	3221912250193	14 L600x550	1	1	66,06
10924231600	3221912250209	16 L600x550	1	1	71,23

**109176**  **TECHNIC DUSTOFF | Broca hormigón | L270 | Mango SDS+**

**1091763** Enganche SDS

CODE	EAN	Dim.	PCB	Qty	€ HT
10917630600	3221912242839	6 L220	1	1	56,16
10917630800	3221912141040	8,00 /L 270x   150	1	1	61,31
10917631000	3221912141057	10,00 /L 270x   150	1	1	65,04
10917631200	3221912141064	12,00 /L 320x   200	1	1	68,65
10917631400	3221912141071	14,00 /L 370x   250	1	1	98,07
10917631600	3221912141088	16,00 /L 370x   250	1	1	109,94
10917631800	3221912141095	18,00 /L 370x   250	1	1	134,71
10917632000	3221912141101	20,00 /L 370x   250	1	1	158,97
10917632400	3221912141118	24,00 /L 370x   250	1	1	183,74

**109310**  **TECHNIC SPEEDER 2 | Broca hormigón 2 cortes | L110 | Mango SDS+ (clip)**

**1093103** Enganche SDS

CODE	EAN	Dim.	PCB	Qty	€ HT
10931030400	3221912048561	4,00 /L 110x   50	1	1	4,15
10931030500	3221912048875	5,00 /L 110x   50	1	1	3,50
10931030600	3221912048882	6,00 /L 110x   50	1	1	3,37
10931030700	3221912048899	7,00 /L 110x   50	1	1	3,94
10931030800	3221912048905	8,00 /L 110x   50	1	1	3,60
10931031000	3221912048912	10,00 /L 110x   50	1	1	3,85

**1093106** Paquete

CODE	EAN	Dim.	PCB	Qty	€ HT
10931060510	3221912069573	5,00 /L 110x   50	1	10	29,75
10931060525	3221912069597	5,00 /L 110x   50	1	25	69,99
10931060605	3221912069559	6,00 /L 110x   50	1	5	15,13
10931060610	3221912069580	6,00 /L 110x   50	1	10	28,59
10931060625	3221912069603	6,00 /L 110x   50	1	25	67,26

**109311**  **TECHNIC SPEEDER 2 | Broca hormigón 2 cortes | L160 | Mango SDS+ (clip)**

**1093113** Enganche SDS

CODE	EAN	Dim.	PCB	Qty	€ HT
10931130500	3221912048929	5,00 /L 160x   100	1	1	4,28
10931130600	3221912048936	6,00 /L 160x   100	1	1	3,51
10931130650	3221912048943	6,50 /L 160x   100	1	1	4,37
10931130700	3221912048974	7,00 /L 160x   100	1	1	4,28
10931130800	3221912048981	8,00 /L 160x   100	1	1	3,70
10931130900	3221912048998	9,00 /L 160x   100	1	1	6,37
10931131000	3221912049001	10,00 /L 160x   100	1	1	4,60
10931131100	3221912049018	11,00 /L 160x   100	1	1	7,40
10931131200	3221912049025	12,00 /L 160x   100	1	1	5,63
10931131300	3221912049032	13,00 /L 160x   100	1	1	9,28
10931131400	3221912049049	14,00 /L 160x   100	1	1	9,28
10931131500	3221912049520	15,00 /L 160x   100	1	1	12,00
10931131600	3221912049056	16,00 /L 160x   100	1	1	11,66

**1093116** Paquete

CODE	EAN	Dim.	PCB	Qty	€ HT
10931160605	3221912069610	6,00 /L 160x   100	1	5	15,79
10931160610	3221912069658	6,00 /L 160x   100	1	10	29,83
10931160625	3221912069696	6,00 /L 160x   100	1	25	70,20
10931160805	3221912069641	8,00 /L 160x   100	1	5	16,69







**Broca hormigón canal simple | L160 | Mango SDS+**

**1091213** Enganche SDS

CODE	EAN	Dim.	PCB Qty	€ HT
10912130500	3221910847548	5,00 /L 160x   100	1   1	2,84
10912130600	3221910847555	6,00 /L 160x   100	1   1	2,51
10912130700	3221910847562	7,00 /L 160x   100	1   1	2,84
10912130800	3221910847579	8,00 /L 160x   100	1   1	2,65
10912131000	3221910847586	10,00 /L 160x   100	1   1	3,27
10912131200	3221910847593	12,00 /L 160x   100	1   1	3,83
10912131400	3221910847609	14,00 /L 160x   100	1   1	5,36



**Broca hormigón canal simple | L210 | Mango SDS+**

**1091223** Enganche SDS

CODE	EAN	Dim.	PCB Qty	€ HT
10912230600	3221910847616	6,00 /L 210x   150	1   1	3,83
10912230650	3221910864712	6,50 /L 210x   150	1   1	4,19
10912230800	3221910847623	8,00 /L 210x   150	1   1	3,35
10912231000	3221910847630	10,00 /L 210x   150	1   1	4,26
10912231200	3221910847647	12,00 /L 210x   150	1   1	5,26
10912231400	3221910847654	14,00 /L 210x   150	1   1	5,98
10912231600	3221910847661	16,00 /L 210x   150	1   1	8,09
10912231800	3221910847678	18,00 /L 210x   150	1   1	11,37



**Broca hormigón canal simple | L260 | Mango SDS+**

**1091233** Enganche SDS

CODE	EAN	Dim.	PCB Qty	€ HT
10912330600	3221910864316	6,00 /L 260x   200	1   1	4,74
10912330650	3221910864309	6,50 /L 260x   200	1   1	4,99
10912330800	3221910847685	8,00 /L 260x   200	1   1	4,88
10912331000	3221910847692	10,00 /L 260x   200	1   1	5,00
10912331200	3221910847708	12,00 /L 260x   200	1   1	5,73
10912331400	3221910847715	14,00 /L 260x   200	1   1	7,37
10912331600	3221910847722	16,00 /L 260x   200	1   1	8,82
10912331800	3221910847739	18,00 /L 260x   200	1   1	11,32
10912332000	3221910866501	20,00 /L 260x   200	1   1	12,67
10912332200	3221910866518	22,00 /L 260x   200	1   1	15,04



**Broca hormigón canal simple | L450 | Mango SDS+**

**1091243** Enganche SDS

CODE	EAN	Dim.	PCB Qty	€ HT
10912430800	3221910847746	8,00 /L 450x   400	1   1	11,28
10912431000	3221910847753	10,00 /L 450x   400	1   1	11,28
10912431200	3221910847760	12,00 /L 450x   400	1   1	11,28
10912431400	3221910847777	14,00 /L 450x   400	1   1	12,68
10912431600	3221910847784	16,00 /L 450x   400	1   1	12,68
10912431800	3221910847791	18,00 /L 450x   400	1   1	18,24
10912432000	3221910847807	20,00 /L 450x   400	1   1	22,97
10912432200	3221910864279	22,00 /L 450x   400	1   1	25,47
10912432400	3221910864323	24,00 /L 450x   400	1   1	29,71
10912432500	3221910847814	25,00 /L 450x   400	1   1	31,49



**MAXTER | Broca hormigón multi cortes | L340 | Mango SDSmax**

**1090553** Enganche SDS

CODE	EAN	Dim.	PCB Qty	€ HT
10905531200	3221910227623	12,00 /L 340x   200	1   1	46,16
10905531400	3221910227630	14,00 /L 340x   200	1   1	53,34
10905531600	3221910227647	16,00 /L 340x   200	1   1	58,20
10905531800	3221910227654	18,00 /L 340x   200	1   1	59,73



**MAXTER | Broca hormigón multi cortes | L320 | Mango SDSmax**

**1090543** Enganche SDS

CODE	EAN	Dim.	PCB Qty	€ HT
10905432000	3221910227586	20,00 /L 320x   200	1   1	62,81
10905432200	3221910227593	22,00 /L 320x   200	1   1	66,56
10905432400	3221910227609	24,00 /L 320x   200	1   1	73,08
10905432500	3221910227616	25,00 /L 320x   200	1   1	72,72



**MAXTER | Broca hormigón multi cortes | L540 | Mango SDSmax**

**1090583** Enganche SDS

CODE	EAN	Dim.	PCB Qty	€ HT
10905831200	3221910227760	12,00 /L 540x   400	1   1	53,44
10905831400	3221910227777	14,00 /L 540x   400	1   1	64,67
10905831600	3221910227784	16,00 /L 540x   400	1   1	68,18
10905831800	3221910227791	18,00 /L 540x   400	1   1	71,78



**MAXTER | Broca hormigón multi cortes | L520 | Mango SDSmax**

**1090573** Enganche SDS

CODE	EAN	Dim.	PCB Qty	€ HT
10905732000	3221910227722	20,00 /L 520x   400	1   1	73,16
10905732200	3221910227739	22,00 /L 520x   400	1   1	77,72
10905732400	3221910227746	24,00 /L 520x   400	1   1	85,60
10905732500	3221910227753	25,00 /L 520x   400	1   1	85,95



**MAXTER | Broca hormigón multi cortes | L520 | Mango SDSmax**

**1090593** Enganche SDS

CODE	EAN	Dim.	PCB Qty	€ HT
10905932800	3221910227807	28,00 /L 520x   450	1   1	97,40
10905933000	3221910227814	30,00 /L 520x   450	1   1	104,02
10905933200	3221910227821	32,00 /L 520x   450	1   1	112,26
10905933500	3221910227838	35,00 /L 520x   450	1   1	125,88
10905933800	3221910227845	38,00 /L 520x   450	1   1	164,35
10905934000	3221910227852	40,00 /L 520x   450	1   1	202,98



**MAXTER | Broca hormigón multi cortes | L920 | Mango SDSmax**

**1090603** Enganche SDS

CODE	EAN	Dim.	PCB Qty	€ HT
10906031600	3221910863210	16,00 /L 920x   800	1   1	109,31
10906031800	3221910863227	18,00 /L 920x   800	1   1	109,46
10906032000	3221910227869	20,00 /L 920x   800	1   1	111,79
10906032200	3221910227876	22,00 /L 920x   800	1   1	116,42
10906032500	3221910227883	25,00 /L 920x   800	1   1	136,67
10906033200	3221910227890	32,00 /L 920x   800	1   1	169,74
10906034000	3221910863234	40,00 /L 920x   800	1   1	283,88



**TECHNIC DUSTOFF | Broca hormigón | L600 | Mango SDSmax**

**1091773** Enganche SDS

CODE	EAN	Dim.	PCB Qty	€ HT
10917731400	3221912141125	14,00 /L 600x   400	1   1	237,42
10917731600	3221912141132	16,00 /L 600x   400	1   1	246,71
10917731800	3221912141149	18,00 /L 600x   400	1   1	257,04
10917732000	3221912141156	20,00 /L 600x   400	1   1	266,32
10917732200	3221912141163	22,00 /L 600x   400	1   1	277,68
10917732500	3221912141170	25,00 /L 600x   400	1   1	288,00
10917732800	3221912141187	28,00 /L 600x   400	1   1	322,06
10917733000	3221912141194	30,00 /L 600x   400	1   1	335,49
10917733200	3221912141200	32,00 /L 600x   400	1   1	356,13
10917733500	3221912141217	35,00 /L 600x   400	1   1	369,55



**HAMMER4 | Broca hormigón multi-filos | Mango SDSmax | Uso común**





CODE	EAN	Dim.	PCB	Qty	€ HT
10900840800	3221910027766	8.00 /L400x   350	1	1	7,41
10900841000	3221910027780	10.00 /L400x   350	1	1	8,02
10900841200	3221910027803	12.00 /L400x   350	1	1	9,23
10900841400	3221910027827	14.00 /L400x   350	1	1	10,11
10900841600	3221910027841	16.00 /L400x   350	1	1	12,14
10900841800	3221910027858	18.00 /L400x   350	1	1	15,14
10900842000	3221910027865	20.00 /L400x   350	1	1	18,31
10900842200	3221910027872	22.00 /L400x   350	1	1	22,35



**TECHNIC | Broca hormigón | Mango hexagonal (blíster)**

1090162 Blister

CODE	EAN	Dim.	PCB	Qty	€ HT
10901620300	3221910024741	3.00 /L80x   30	1	1	3,90
10901620400	3221910024758	4.00 /L80x   35	1	1	3,90
10901620500	3221910024765	5.00 /L85x   40	1	1	4,07
10901620600	3221910024772	6.00 /L100x   50	1	1	4,41
10901620800	3221910835941	8.00 /L120x   80	1	1	5,39
10901621000	3221910835958	10.00 /L120x   80	1	1	6,36



**Broca hormigón | Mango cilíndrico (funda)**

5090014 Funda plástico

CODE	EAN	Dim.	PCB	Qty	€ HT
50900140300	3221910027223	3	6	2	1,39
50900140400	3221910027230	4	6	2	1,39
50900140500	3221910027247	5	6	2	1,44
50900140600	3221910027261	6	6	1	1,08
50900140700	3221910027285	7	6	1	1,11
50900140800	3221910027292	8	6	1	1,17
50900140900	3221910027308	9	6	1	1,51
50900141000	3221910027315	10	6	1	1,51
50900141100	3221910027322	11	1	1	1,95
50900141200	3221910027339	12	1	1	2,03
50900141400	3221910027353	14	1	1	3,15
50900141600	3221910027377	16	1	1	5,01



**10922770003**

EAN : 3221912240927  
**7 brocas SDS+ 3 cortes**  
**L110-160mm de Ø5 a**  
**12mm | TECHNIC**  
**MASTER 3**

L110mm: Ø5mm -6mm -8mm /  
 L160mm: Ø6mm -8mm -10mm -12mm  
 | Estuche Ranger

Pcs : 7 **83,62 €**



**10931070001**

EAN : 3221912086983  
**5 brocas SDS+ 2 cortes**  
**L110-160mm de Ø6 a**  
**10mm | TECHNIC**  
**SPEEDER 2**

L110mm: Ø5mm -6mm / L160mm:  
 Ø6mm -8mm -10mm | Enganche

Pcs : 5 **21,62 €**



**10931070002**

EAN : 3221912086990  
**10 brocas SDS+ 2 cortes**  
**L110-160mm de Ø6 a**  
**14mm | TECHNIC**  
**SPEEDER 2**

L110mm: Ø6mm x3 / L160mm: Ø8mm  
 x3 Ø10mm x2 Ø12mm Ø14mm |  
 Enganche

Pcs : 10 **47,43 €**



**10922770001**

EAN : 3221910899691  
**5 brocas SDS+ 3 cortes**  
**L110-160mm de Ø5 a**  
**10mm | TECHNIC**  
**MASTER 3**

L110mm: Ø5mm -6mm / L160mm:  
 Ø6mm -8mm -10mm | Enganche

Pcs : 5 **44,84 €**



**10922770002**

EAN : 3221912087003  
**10 brocas SDS+ 3 cortes**  
**L110-160mm de Ø6 a**  
**14mm | TECHNIC**  
**MASTER 3**

L110mm: Ø6mm x3 / L160mm: Ø8mm  
 x3 Ø10mm x2 Ø12mm Ø14mm |  
 Enganche

Pcs : 10 **113,50 €**



**10901070005**

EAN : 3221910039134  
**8 brocas SDS+ TECHNIC**  
**SPEEDER 2, L110 y L160,**  
**de Ø4 a 12mm**

Broca SDS+ canal doble L110mm:  
 Ø4mm -5mm -6mm / L160mm: Ø6mm  
 -8mm -10mm -12mm | Estuche Ranger

Pcs : 7 **40,90 €**



**10901070040**

EAN : 3221910821029  
**3 piezas: Puntero y Cíncel**  
**SDS+ L140mm |**  
**KOMPACT**

Punta L140mm / Cíncel pala 20x140 -  
 40x140 | Enganche

Pcs : 3 **30,89 €**

**10901070043**

EAN : 3221910857776  
**3 piezas: Puntero y Cincel SDS+ L250mm | PACK DEMOLICIÓN**

Punta L250mm / Cincel pala 20x250 - 40x250 | Enganche

Pcs : 3 **51,37 €**

**10904870001**

EAN : 3221912040237  
**10 brocas hormigón SDS+ L110-160mm de Ø4 a 10mm**

L110mm: Ø4mm -5mm -6mm -8mm / L160mm: Ø5mm -6mm -6mm -8mm -9mm -10mm | Estuche Ranger

Pcs : 10 **38,39 €**

**10901070046**

EAN : 3221910861735  
**5 brocas SDS+ canal simple L110mm de Ø4 a 6mm**

L110mm: Ø4mm -5mm -5mm -6mm -6mm | Enganche

Pcs : 5 **14,92 €**

**10960570002**

EAN : 3221912022929  
**5 brocas hormigón TECHNIC graduadas de Ø4 a 10mm**

Ø4mm -5mm -6mm -8mm -10mm | Estuche Clipster

Pcs : 5 **24,64 €**

**10901070047**

EAN : 3221910861742  
**5 brocas SDS+ canal simple L160mm de Ø6 a 10mm**

L160mm: Ø6mm -6mm -8mm -8mm -10mm | Enganche

Pcs : 5 **16,10 €**

**10960570001**

EAN : 3221912022912  
**8 brocas hormigón TECHNIC graduadas de Ø3 a 10mm**

Ø3mm -4mm -5mm -6mm -7mm -8mm -9mm -10mm | Estuche Clipster

Pcs : 8 **35,04 €**

**10904770001**

EAN : 3221912040206  
**9 brocas hormigón PRO de Ø3 a 12mm**

Ø3mm -4mm -5mm -6mm -7mm -8mm -9mm -10mm -12mm | Estuche Ranger

Pcs : 9 **27,83 €**

**10960570018**

EAN : 3221912263100  
**9 brocas hormigón TECHNIC graduadas de Ø3 a 12mm**

Ø3mm -4mm -5mm -6mm -7mm -8mm -9mm -10mm -12mm | Estuche Ranger

Pcs : 9 **44,00 €**

**50901070001**

EAN : 3221910835019  
**6 brocas SDS+ canal simple L110-160mm de Ø4 a 10mm**

L110mm: Ø4mm -5mm / L160mm: Ø6mm -7mm -8mm -10mm | Estuche blister

Pcs : 6 **19,85 €**

**10960370003**

EAN : 3221912107121  
**3 brocas hormigón INDUSTRY graduadas de Ø5 a 8mm**

Ø5mm -6mm -8mm

Pcs : 3 **8,86 €**

**10960370033**

EAN : 3221910840822  
**5 brocas hormigón  
 INDUSTRY graduadas de  
 Ø4 a 10mm**

Ø4mm -5mm -6mm -8mm -10mm |  
 Estuche Clipster

Pcs : 5

**16,86 €****10901670001**

EAN : 3221910866600  
**5 brocas hormigón  
 mango hexagonal de Ø3  
 a 8mm**

Ø3mm -4mm -5mm -6mm -8mm

Pcs : 5

**8,81 €****10960370034**

EAN : 3221910840839  
**8 brocas hormigón  
 INDUSTRY graduadas de  
 Ø3 a 10mm**

Ø3mm -4mm -5mm -6mm -7mm  
 -8mm -9mm -10mm | Estuche Clipster

Pcs : 8

**23,97 €****10901670002**

EAN : 3221912161697  
**5 brocas hormigón  
 mango hexagonal Shock  
 Series de Ø3 a 8mm |  
 TECHNIC**

Ø3mm -4mm -5mm -6mm -8mm |  
 Estuche Clipster

Pcs : 5

**14,46 €****10960370018**

EAN : 3221910849399  
**9 brocas hormigón  
 INDUSTRY graduadas de  
 Ø3 a 12mm**

Ø3mm -4mm -5mm -6mm -7mm  
 -8mm -9mm -10mm -12mm | Estuche  
 Ranger

Pcs : 9

**35,89 €****50900170018**

EAN : 3221910018146  
**5 brocas hormigón  
 ESTÁNDAR de Ø4 a  
 10mm**

Ø4mm -5mm -6mm -8mm -10mm

Pcs : 5

**5,98 €****10900270033**

EAN : 3221910050870  
**5 brocas hormigón  
 EXTRA de Ø4 a 10mm**

Ø4mm -5mm -6mm -8mm -10mm |  
 Estuche Clipster

Pcs : 5

**14,16 €****50900170019**

EAN : 3221910018122  
**8 brocas hormigón  
 ESTÁNDAR de Ø3 a  
 10mm**

Ø3mm -4mm -5mm -6mm -7mm  
 -8mm -9mm -10mm

Pcs : 8

**9,34 €****10900270034**

EAN : 3221910050887  
**8 brocas hormigón  
 EXTRA de Ø3 a 10mm**

Ø3mm -4mm -5mm -6mm -7mm  
 -8mm -9mm -10mm | Estuche Clipster

Pcs : 8

**19,69 €**



**109015** **TECHNIC | Cincel | Puntero | SDS+ | Alto rendimiento**

└─ **1090153** Enganche plástico

CODE	EAN	Dim.	PCB Qty	€ HT
10901530009	3221912199119	L250 HPP	1   1	20,65



**109090** **Cincel | Puntero | SDS+**

└─ **1090903** Enganche SDS

CODE	EAN	Dim.	PCB Qty	€ HT
10901530001	3221910234812	L 250 /SDS+	1   1	13,49



**109091** **TECHNIC | Cincel | Pala | SDS+ | Alto rendimiento**

└─ **1090913** Enganche SDS

CODE	EAN	Dim.	PCB Qty	€ HT
10901530010	3221912199126	L20x250 HPP	1   1	20,65



**109092** **Cincel | Pala | SDS+**

└─ **1090923** Enganche SDS

CODE	EAN	Dim.	PCB Qty	€ HT
10901530002	3221910234829	20.00 L 250 /SDS+	1   1	13,70



**109093** **TECHNIC | Cincel | Pala | SDS+ | Alto rendimiento**

└─ **1090933** Enganche SDS

CODE	EAN	Dim.	PCB Qty	€ HT
10901530011	3221912199133	L40x250 HPP	1   1	32,00



**109094** **Cincel | Pala | SDS+**

└─ **1090943** Enganche SDS

CODE	EAN	Dim.	PCB Qty	€ HT
10901530004	3221910234843	40.00 L 250 /SDS+	1   1	21,16



**109095** **Cincel | Codo | SDS+**

└─ **1090953** Enganche SDS

CODE	EAN	Dim.	PCB Qty	€ HT
10901530005	3221910555894	40.00 L 250 /SDS+	1   1	26,22



**109096** **Cincel | SDS+**

└─ **1090963** Enganche SDS

CODE	EAN	Dim.	PCB Qty	€ HT
10901530007	3221910863012	40.00 L 250 /SDS+	1   1	26,82



**109097**

**Cincel | SDS+**

└─ **1090973** Enganche SDS

CODE	EAN	Dim.	PCB Qty	€ HT
10901530006	3221910863005	60.00 L 250 /SDS+	1   1	32,99



**109098** **Cincel | Embaldosados | SDS+**

└─ **1090983** Enganche SDS

CODE	EAN	Dim.	PCB Qty	€ HT
10901530008	3221910863029	40.00 L 250 /SDS+	1   1	21,87



**109099** **Rozador | SDS+**

└─ **1090993** Enganche SDS

CODE	EAN	Dim.	PCB Qty	€ HT
10901530003	3221910234836	22.00 L 250 /SDS+	1   1	28,54



**109180** **TECHNIC | Cincel | Puntero | SDSmax | Alto rendimiento**

└─ **1091803** Enganche SDS

CODE	EAN	Dim.	PCB Qty	€ HT
10906130001	3221912199171	L400 HPP	1   1	26,84



**109061** **Cincel | Puntero | SDSmax**

└─ **1090613** Enganche SDS

CODE	EAN	Dim.	PCB Qty	€ HT
109061328000	3221910227906	L 280 /SDSmax	1   1	17,88
109061340000	3221910227913	L 400 /SDSmax	1   1	18,14
109061360000	3221910863289	L 600 /SDSmax	1   1	24,71



**109181** **TECHNIC | Cincel | Pala | SDSmax | Alto rendimiento**

└─ **1091813** Enganche SDS

CODE	EAN	Dim.	PCB Qty	€ HT
10906230001	3221912199188	25 /L400 HPP	1   1	26,84
10906230002	3221912199195	50 /L400 HPP	1   1	44,39



**109062** **Cincel | Pala | SDSmax**

└─ **1090623** Enganche SDS

CODE	EAN	Dim.	PCB Qty	€ HT
1090623250280	3221910227920	25.00 L 280 / SDSmax	1   1	15,63
1090623250400	3221910227937	25.00 L 400 / SDSmax	1   1	18,14
1090623250600	3221910863302	25.00 L 600 / SDSmax	1   1	24,71
1090623500400	3221910863319	50.00 L 400 / SDSmax	1   1	27,29
1090623800300	3221910863326	80.00 L 300 / SDSmax	1   1	46,90
10906231150350	3221910863296	115.00 L 350 / SDSmax	1   1	91,98



**109182** **Cincel | SDSmax**



└─ **1091823** Enganche SDS  
 CODE EAN Dim. PCB Qty € HT  
 10906330001 | 3221910863333 | 50 L 350 /SDSmax | 1 | 1 | 40,17

**109183**   
**Cinzel | Embaldosado | SDSmax**

└─ **1091833** Enganche SDS  
 CODE EAN Dim. PCB Qty € HT  
 10906330002 | 3221910863340 | 50 L 300 /SDSmax | 1 | 1 | 49,72

**109184**   
**Rozador | SDSmax**

└─ **1091843** Enganche SDS  
 CODE EAN Dim. PCB Qty € HT  
 1090633260300 | 3221910227944 | 26 L 300 /SDSmax | 1 | 1 | 57,28

**109185**   
**Cinzel | Canal | SDSmax**

└─ **1091853** Enganche SDS  
 CODE EAN Dim. PCB Qty € HT  
 10906330004 | 3221910863364 | 32 L 300 /SDSmax | 1 | 1 | 43,11

**109186**   
**Cinzel | Dentado | SDSmax**

└─ **1091863** Enganche SDS  
 CODE EAN Dim. PCB Qty € HT  
 10906330005 | 3221910863371 | 32 L 300 /SDSmax | 1 | 1 | 51,41

**109187**   
**Cinzel | Dentado | HM | SDSmax**

└─ **1091873** Enganche SDS  
 CODE EAN Dim. PCB Qty € HT  
 10906330006 | 3221910863388 | 32 L 300 /SDSmax | 1 | 1 | 129,51

**109188**   
**Cinzel | Mortero | SDSmax**

└─ **1091883** Enganche SDS  
 CODE EAN Dim. PCB Qty € HT  
 10906330007 | 3221910863395 | 10 L 300 /SDSmax | 1 | 1 | 64,65

**109063**   
**Cinzel | Mortero | SDSmax**

└─ **1090633** Enganche SDS  
 CODE EAN Dim. PCB Qty € HT  
 10906330003 | 3221910863357 | 50 L 300 /SDSmax | 1 | 1 | 56,24

**109231**   
**Cinzel | Puntero | HEXA30**

└─ **1092311** Tubo colgable

CODE EAN Dim. PCB Qty € HT  
 109231140000 | 3221912039668 | L 400 /Hexa30 | 1 | 1 | 41,19

**109189**   
**Cinzel | Pala | HEXA30**

└─ **1091891** Tubo colgable  
 CODE EAN Dim. PCB Qty € HT  
 1092311300400 | 3221912039651 | 30.00 L 400 /Hexa30 | 1 | 1 | 38,09

**109190**   
**Cinzel | Pala | HEXA30**

└─ **1091901** Tubo colgable  
 CODE EAN Dim. PCB Qty € HT  
 1092311500400 | 3221912039644 | 50.00 L 400 /Hexa30 | 1 | 1 | 48,41



**10901070048**  
 EAN : 3221912199201  
**3 piezas: Puntero y Cinzel SDS+ L250mm | TECHNIC**  
 Puntero L250mm / Cinzel pala 20x250 - 40x250 | PACK DEMOLICION | Enganche

Pcs : 3 **73,30 €**

120009

**TECHNIC | Brocas Diamante en seco | Mango Hexagonal**

1200092 Blister

CODE	EAN	Dim.	PCB	Qty	€ HT
12000920500	3221912064783	5.00 /L55	1	1	31,20
12000920600	3221912064790	6.00 /L65	1	1	31,20
12000920800	3221912064806	8.00 /L80	1	1	31,20
12000921000	3221912064813	10.00 /L80	1	1	31,20



120008

**Broca DIAMANTE | Mango Hexagonal (blister)**

1200082 Blister

CODE	EAN	Dim.	PCB	Qty	€ HT
12000820500	3221912064851	5.00 /L55	1	1	8,91
12000820600	3221912064868	6.00 /L55	3	1	9,26
12000820700	3221912064875	7.00 /L55	1	1	9,60
12000820800	3221912064882	8.00 /L55	3	1	9,99
12000821000	3221912064899	10.00 /L55	3	1	10,30
12000821200	3221912065001	12.00 /L55	1	1	11,00
12000822500	3221912065018	25.00 /L55	1	1	13,79



120003

**EXTRA | Broca porcelánico | Mango cilíndrico (blister)**

1200032 Blister

CODE	EAN	Dim.	PCB	Qty	€ HT
12000320400	3221910203788	4.00 /L75x I 40	1	1	3,43
12000320500	3221910203795	5.00 /L85x I 40	1	1	3,67
12000320600	3221910203801	6.00 /L100x I 60	1	1	4,12
12000320700	3221910203818	7.00 /L100x I 60	1	1	4,35
12000320800	3221910203825	8.00 /L120x I 80	1	1	4,96
12000321000	3221910853228	10.00 /L120x I 80	1	1	6,56
12000321200	3221910853235	12.00 /L120x I 80	1	1	9,41



1200034 Funda plástico

CODE	EAN	Dim.	PCB	Qty	€ HT
12000340400	3221910205805	4.00 /L75x I 40	1	1	3,43
12000340500	3221910205812	5.00 /L85x I 40	1	1	3,67
12000340600	3221910205829	6.00 /L100x I 60	1	1	4,12
12000340700	3221910205836	7.00 /L100x I 60	1	1	4,35
12000340800	3221910205843	8.00 /L120x I 80	1	1	4,96
12000341000	3221910866327	10.00 /L120x I 80	1	1	6,56
12000341200	3221910866334	12.00 /L120x I 80	1	1	9,41



**12000820001**

EAN : 3221912176776  
**7 piezas: 4 brocas azulejo/hormigón de Ø6 a 8mm + guía + acc.**

Broca Diamante Ø6mm -8mm / Brocas 2en1 embaldosado -hormigón Ø6mm -8mm / 1 guía de taladrado / 1 nivel de burbuja / 1 lápiz | Blister

Pcs : 7 **31,94 €**



**12000820002**

EAN : 3221912223456  
**7 piezas: 4 brocas azulejo/hormigón de Ø5 a 10mm + guía (blister)**

Ø5mm -6mm -8mm -10mm + 1 guía de taladrado

Pcs : 5 **37,06 €**



**12000370001**

EAN : 3221910853242  
**5 brocas porcelánico de Ø4 a 10mm**

Ø4mm -5mm -6mm -8mm -10mm | Estuche Clipster

Pcs : 5 **21,98 €**



**12000370002**

EAN : 3221912108265  
**5 brocas porcelánico de Ø3 a 8mm**

Ø3mm -4mm -5mm -6mm -8mm

Pcs : 5 **18,64 €**



**12000540001**

EAN : 3221910880927  
**3 brocas DIAMANTE EXTRA de Ø5 a 8mm | Mango hexagonal**

Ø5mm -6mm -8mm

Pcs : 3 **27,13 €**



**12000540002**

EAN : 3221910880934  
**3 brocas DIAMANTE EXTRA de Ø8 a 12mm | Mango hexagonal**

Ø8mm -10mm -12mm

Pcs : 3 **29,66 €**



**109130**  
**TECHNIC | Broca 2en1 hormigón/azulejo | Mango cilíndrico | Alto rendimiento**

└─ **1091302** Blister

CODE	EAN	Dim.	PCB	Qty	€ HT
10913020400	3221912064936	4.00 /L75x l 40	3	1	5,10
10913020500	3221912064943	5.00 /L85x l 50	3	1	7,29
10913020600	3221912064950	6.00 /L100x l 60	3	1	8,34
10913020800	3221912064967	8.00 /L120x l 80	1	1	9,21
10913021000	3221912064974	10.00 /L120x l 80	1	1	10,06



**108044**  
**TECHNIC | Broca 2en1 madera/metal | Alto rendimiento (blister)**

└─ **1080442** Blister

CODE	EAN	Dim.	PCB	Qty	€ HT
10804420200	3221912064929	2.00 /L49	3	1	2,66
10804420250	3221912064677	2.50 /L57	3	1	3,33
10804420300	3221912064691	3.00 /L61	3	1	3,92
10804420350	3221912064707	3.50 /L70	3	1	3,96
10804420400	3221912064653	4.00 /L75	3	1	3,98
10804420500	3221912064714	5.00 /L86	3	1	4,86
10804420600	3221912064721	6.00 /L93	3	1	5,30
10804420800	3221912064738	8.00 /L117	1	1	7,57



**119017**  
**Broca multi-material 3en1 | Mango cilíndrico**

└─ **1190172** Blister

CODE	EAN	Dim.	PCB	Qty	€ HT
11901720300	3221910221881	3.00 /L60x l 30	1	1	2,42
11901720400	3221910221898	4.00 /L75x l 40	1	1	2,78
11901720500	3221910221904	5.00 /L85x l 50	1	1	3,62
11901720600	3221910221911	6.00 /L100x l 60	1	1	3,67
11901720800	3221910221928	8.00 /L120x l 80	1	1	4,95



**120017**  
**Broca NIEVE&HIELO**

└─ **1200174** Funda plástico

CODE	EAN	Dim.	PCB	Qty	€ HT
12001743200	3221912262684	32 /L540	1	1	278,00
12001743500	3221912262691	35 /L540	1	1	278,00
12001743800	3221912275011	38 /L540	1	1	291,00



**10804470002**

EAN : 3221912064981  
**6 brocas 2en1 madera-metal de Ø2 a 8mm | TECHNIC**

Ø2mm -3mm -4mm -5mm -6mm -8mm | Estuche Clipster

Pcs : 6 **28,92 €**



**11901770002**

EAN : 3221912107107  
**5 brocas 3in1 multimaterial de Ø3 a 8mm**

Ø3mm -4mm -5mm -6mm -8mm

Pcs : 5 **20,49 €**



**10913070002**

EAN : 3221912064998  
**5 brocas 2en1 hormigón azulejo de Ø4 a 10mm | TECHNIC**

Ø4mm -5mm -6mm -8mm -10mm | Estuche Clipster

Pcs : 5 **41,31 €**

120011 

**TECHNIC | Broca vidrio | Mango cilíndrico**

└ 1200112 Blister

CODE	EAN	Dim.	PCB	Qty	€ HT
12001120400	3221912098191	4.00 /L105	1	1	23,48
12001120500	3221912098207	5.00 /L105	1	1	23,07
12001120600	3221912098214	6.00 /L115	1	1	23,90
12001120800	3221912098221	8.00 /L120	1	1	27,02
12001121000	3221912098238	10.00 /L120	1	1	29,96



120004 

**TECHNIC | Broca vidrio | Mango hexa (blister)**

└ 1200042 Blister

CODE	EAN	Dim.	PCB	Qty	€ HT
12000420400	3221910007515	4.00 /L65	1	1	7,74
12000420500	3221910007522	5.00 /L65	1	1	8,20
12000420600	3221910007539	6.00 /L65	1	1	8,64
12000420700	3221910007546	7.00 /L70	1	1	9,09
12000420800	3221910007553	8.00 /L70	1	1	9,51



└ 1200044 Funda plástico

CODE	EAN	Dim.	PCB	Qty	€ HT
12000440400	3221910205850	4.00 /L65	1	1	7,74
12000440500	3221910205867	5.00 /L65	1	1	8,20
12000440600	3221910205874	6.00 /L65	1	1	8,64
12000440700	3221910205881	7.00 /L70	1	1	9,09
12000440800	3221910205898	8.00 /L70	1	1	9,51



**12000770001**

EAN : 3221910900397  
**5 brocas vidrio mango hexagonal de Ø3 a 8mm**  
 Ø3mm -4mm -5mm -6mm -8mm

Pcs : 5 **17,68 €**



120010 

**TECHNIC | Broca especial para taladrado de placas de escayola y soportes**

└ 1200102 Blister

CODE	EAN	Dim.	PCB	Qty	€ HT
12001020800	3221912141484	8	1	1	6,23
12001021000	3221912141491	10	1	1	7,02
12001021100	3221912148568	11	1	1	7,09
12001021200	3221912229502	12	1	1	8,16





**TECHNIC | Broca madera | Mango cilíndrico (blíster)**

**1086402** Blister

CODE	EAN	Dim.	PCB	Qty	€ HT
10864020200	3221912023193	2,00 /L49	3	1	2,37
10864020250	3221912023216	2,50 /L49	3	1	2,94
10864020300	3221912019158	3,00 /L61	3	1	3,84
10864020400	3221912019172	4,00 /L75	3	1	4,03
10864020500	3221912019189	5,00 /L86	3	1	4,80
10864020600	3221912019196	6,00 /L93	3	1	5,47
10864020700	3221912019202	7,00 /L109	1	1	6,74
10864020800	3221912019219	8,00 /L117	1	1	7,13
10864020900	3221912019233	9,00 /L125	1	1	8,42
10864020950	3221912062116	9,50 /L133	1	1	11,05
10864021000	3221912019240	10,00 /L133	1	1	8,88
10864021100	3221912062123	11,00 /L142	1	1	13,41
10864021200	3221912019257	12,00 /L151	1	1	13,08
10864021300	3221912062130	13,00 /L151	1	1	16,03

**1086404** Funda plástico

CODE	EAN	Dim.	PCB	Qty	€ HT
10864040200	3221912030030	2,00 /L49	3	1	2,37
10864040250	3221912030108	2,50 /L49	3	1	2,94
10864040300	3221912030078	3,00 /L61	3	1	3,84
10864040400	3221912030375	4,00 /L75	3	1	4,03
10864040500	3221912030382	5,00 /L86	3	1	4,80
10864040600	3221912030399	6,00 /L93	3	1	5,47
10864040700	3221912030405	7,00 /L109	1	1	6,74
10864040800	3221912030412	8,00 /L117	1	1	7,13
10864040900	3221912030429	9,00 /L125	1	1	8,42
10864041000	3221912030436	10,00 /L133	1	1	8,88
10864041200	3221912030443	12,00 /L151	1	1	13,08



**EXTRA | Broca madera 3 puntas | Mango cilíndrico (blíster)**

**1086382** Blister

CODE	EAN	Dim.	PCB	Qty	€ HT
10863820300	3221910840341	3,00 /L61	6	1	2,01
10863820400	3221910840358	4,00 /L75	6	1	2,07
10863820500	3221910840365	5,00 /L86	6	1	2,71
10863820600	3221910840372	6,00 /L93	6	1	3,25
10863820700	3221910840389	7,00 /L109	6	1	3,30
10863820800	3221910840396	8,00 /L114	6	1	3,45
10863820900	3221910840402	9,00 /L125	6	1	3,54
10863821000	3221910840419	10,00 /L133	6	1	3,95
10863821100	3221910840426	11,00 /L142	1	1	5,22
10863821200	3221910840433	12,00 /L151	1	1	5,86
10863821300	3221910840440	13,00 /L151	1	1	7,12
10863821400	3221910840457	14,00 /L160	1	1	8,15
10863821500	3221910840464	15,00 /L169	1	1	9,30
10863821600	3221910840471	16,00 /L178	1	1	10,32
10863821800	3221910840488	18,00 /L191	1	1	13,53
10863822000	3221910840495	20,00 /L205	1	1	16,47

**1086384** Funda plástico

CODE	EAN	Dim.	PCB	Qty	€ HT
10863840300	3221910840181	3,00 /L61	6	1	2,01
10863840400	3221910840198	4,00 /L75	6	1	2,07
10863840500	3221910840204	5,00 /L86	6	1	2,71
10863840600	3221910840211	6,00 /L93	6	1	3,25
10863840700	3221910840228	7,00 /L109	6	1	3,30
10863840800	3221910840235	8,00 /L117	6	1	3,45
10863840900	3221910840242	9,00 /L125	6	1	3,54
10863841000	3221910840259	10,00 /L133	6	1	3,95
10863841100	3221910840266	11,00 /L142	1	1	5,22
10863841200	3221910840273	12,00 /L151	1	1	5,86
10863841300	3221910840280	13,00 /L151	1	1	7,12
10863841400	3221910840297	14,00 /L160	1	1	8,15
10863841500	3221910840303	15,00 /L169	1	1	9,30
10863841600	3221910840310	16,00 /L178	1	1	10,32
10863841800	3221910840327	18,00 /L191	1	1	13,53
10863842000	3221910840334	20,00 /L205	1	1	16,47



**EXTRA | Broca madera 3 puntas | Mango cilíndrico**

**1080381** Funda

CODE	EAN	Dim.	PCB	Qty	€ HT
10803810300	3221910117351	3,00 /L61	10	1	1,70
10803810400	3221910117368	4,00 /L75	10	1	1,76
10803810500	3221910117375	5,00 /L86	10	1	2,29
10803810600	3221910117382	6,00 /L93	10	1	2,85
10803810700	3221910117399	7,00 /L109	10	1	2,82
10803810800	3221910117405	8,00 /L117	10	1	2,96
10803811000	3221910117429	10,00 /L133	5	1	3,38



108042

**TECHNIC | Broca madera 3 puntas L250 | Mango cilíndrico**

**1080422** Blister

CODE	EAN	Dim.	PCB	Qty	€ HT
10804220400	3221912061393	4,00 /L250	1	1	10,53
10804220500	3221912061409	5,00 /L250	1	1	10,53



**TECHNIC | Broca madera 3 puntas L250 | Mango cilíndrico (blíster)**

**1080042** Blister

CODE	EAN	Dim.	PCB	Qty	€ HT
10800420600	3221910008499	6,00 /L250	1	1	9,61
10800420800	3221910008505	8,00 /L250	1	1	11,63

**1080044** Blister

CODE	EAN	Dim.	PCB	Qty	€ HT
10800440600	3221910026660	6,00 /L250	1	1	9,61
10800440800	3221910026677	8,00 /L250	1	1	11,63



**TECHNIC | Broca madera 3 puntas L250 | Mango cilíndrico (blíster)**

**1080052** Blister

CODE	EAN	Dim.	PCB	Qty	€ HT
10800521000	3221910001513	10,00 /L250	1	1	16,51
10800521200	3221910001520	12,00 /L250	1	1	17,11

**1080054** Funda plástico

CODE	EAN	Dim.	PCB	Qty	€ HT
10800541000	3221910026684	10,00 /L250	1	1	16,51
10800541200	3221910026691	12,00 /L250	1	1	17,11



**TECHNIC | Broca madera 3 puntas L250-400 | Mango cilíndrico (blíster)**

**1080062** Blister

CODE	EAN	Dim.	PCB	Qty	€ HT
10800621400	3221910001537	14,00 /L300	1	1	25,73
10800621600	3221910001544	16,00 /L300	1	1	33,79

**1080064** Funda plástico

CODE	EAN	Dim.	PCB	Qty	€ HT
10800641400	3221910026707	14,00 /L400	1	1	25,73
10800641600	3221910026714	16,00 /L400	1	1	33,79



**TECHNIC | Broca madera 3 puntas L350-400 | Mango cilíndrico (blíster)**

**1080072** Blister

CODE	EAN	Dim.	PCB	Qty	€ HT
10800721800	3221910039257	18,00 /L400	1	1	35,86
10800722000	3221910039264	20,00 /L400	1	1	39,49

**1080074** Funda plástico

CODE	EAN	Dim.	PCB	Qty	€ HT
10800741800	3221910040765	18,00 /L400	1	1	35,86
10800742000	3221910040772	20,00 /L400	1	1	39,49



**EXTRA | Broca madera 3 puntas | Mango cilíndrico**

**1080452** Blister





**1080163** Enganche SDS  
**TECHNIC | Broca simple espiral para madera L200 | Mango SDS+**

CODE	EAN	Dim.	PCB	Qty	€ HT
10804722500	3221912140166	25.00	1	1	43,98
10804723000	3221912140173	30.00	1	1	49,15
10804723500	3221912140180	35.00	1	1	56,03

**1080163** Enganche SDS

CODE	EAN	Dim.	PCB	Qty	€ HT
10801630600	3221910835477	6.00 /L200	1	1	12,03
10801630700	3221910835484	7.00 /L200	1	1	11,96
10801630800	3221910835491	8.00 /L200	1	1	11,96
10801630900	3221910835507	9.00 /L200	1	1	11,96
10801631000	3221910835514	10.00 /L200	1	1	12,50
10801631200	3221910835521	12.00 /L200	1	1	12,50
10801631400	3221910835538	14.00 /L200	1	1	14,18
10801631600	3221910835545	16.00 /L200	1	1	15,76
10801631800	3221910835552	18.00 /L200	1	1	18,06
10801632000	3221910835569	20.00 /L200	1	1	19,90
10801632200	3221910835576	22.00 /L200	1	1	22,37
10801632400	3221910835583	24.00 /L200	1	1	27,17
10801632600	3221910835590	26.00 /L200	1	1	30,32
10801633000	3221910835606	30.00 /L200	1	1	39,30



**1080183** Enganche SDS  
**TECHNIC | Broca simple espiral para madera L450 | Mango SDS+**

**1080183** Enganche SDS

CODE	EAN	Dim.	PCB	Qty	€ HT
10801830800	3221910835613	8.00 /L450	1	1	20,37
10801831000	3221910835620	10.00 /L450	1	1	20,81
10801831200	3221910835637	12.00 /L450	1	1	21,89
10801831400	3221910835644	14.00 /L450	1	1	24,60
10801831600	3221910835651	16.00 /L450	1	1	26,50
10801831800	3221910835668	18.00 /L450	1	1	29,70
10801832000	3221910835675	20.00 /L450	1	1	32,56
10801832200	3221910835682	22.00 /L450	1	1	35,11
10801832400	3221910835699	24.00 /L450	1	1	38,69



**1080102** Blister  
**TECHNIC | Broca madera | Extensible | Mango cilíndrico**

**1080102** Blister

CODE	EAN	Dim.	PCB	Qty	€ HT
10801021345	3221910000301	15>45	1	1	33,79



**1110242** Blister  
**TECHNIC | Brocas para visagra | Mango cilíndrico**

**1110242** Blister

CODE	EAN	Dim.	PCB	Qty	€ HT
11102421500	3221910222550	15.00	1	1	19,37
11102422000	3221910222567	20.00	1	1	20,37
11102422600	3221910018962	26.00	1	1	12,42
11102423000	3221910018979	30.00	1	1	13,32
11102423500	3221910018986	35.00	1	1	13,82



**1080462** Blister  
**TECHNIC | Fresa para encastrar | FORSTNER**

**1080462** Blister

CODE	EAN	Dim.	PCB	Qty	€ HT
10804621500	3221912140043	15.00	1	1	9,04
10804622000	3221912140050	20.00	1	1	10,24
10804622500	3221912140067	25.00	1	1	11,04
10804623000	3221912140074	30.00	1	1	11,47
10804623500	3221912140081	35.00	1	1	12,43
10804624000	3221912140098	40	1	1	14,72
10804624500	3221912140104	45	1	1	16,39
10804625000	3221912140111	50	1	1	17,14



**1080472** Blister  
**TECHNIC | Brocas para taponar**

**1080472** Blister

CODE	EAN	Dim.	PCB	Qty	€ HT
10804721500	3221912140142	15.00	1	1	32,35
10804722000	3221912140159	20.00	1	1	39,11



**1190072** Blister  
**TECHNIC | Broca & fresa | Metal**

**1190072** Blister

CODE	EAN	Dim.	PCB	Qty	€ HT
11900720300	3221910928391	3	1	1	15,40
11900720400	3221912257192	4	1	1	15,66
11900720500	3221912257215	5	1	1	16,10



**1190062** Blister  
**TECHNIC | Broca y fresa para madera | Mango cilíndrico**

**1190062** Blister

CODE	EAN	Dim.	PCB	Qty	€ HT
11900620300	3221910019006	3	1	1	8,82
11900620400	3221910019013	4	1	1	9,23
11900620500	3221910019020	5	1	1	9,65
11900620600	3221910019037	6	1	1	11,49



**1110234** Tubo colgable  
**Topo colocación tarima | Mango hexagonal (funda rígida)**

**1110234** Tubo colgable

CODE	EAN	Dim.	PCB	Qty	€ HT
11102340400	3221910880446	2,5	1	1	35,99
11102340500	3221910880453	3	1	1	35,99



**11900770001**

EAN : 3221912291196  
**13 piezas | 3 kits de broca+fresa con topo de profundidad + 6 brocas HSS mango hexagonal + 3 puntas inox + Accesorios**

KIT 3 BROCAS Y FRESAS Ø3-4-5mm con TOPES DE PROFUNDIDADES REGULABLES sin herramientas - Acompañado de 6 brocas adicionales y 3 puntas de atornillado INOX PZ2 TX20 TX25

Pcs : 13 **68,00 €**



**XT60612000219**

EAN : 3128820002190  
**Mortajadora Ø10mm**

Pcs : 1 **10,92 €**



**10864070003**

EAN : 3221912087072  
**5 brocas madera de Ø2 a 5mm | TECHNIC (blister)**

Ø2mm -2,5mm -3mm -4mm -5mm

Pcs : 5 **16,08 €**

**10864070002**

EAN : 3221912022820  
**6 brocas madera TECHNIC de Ø2 a 8mm**

Ø2mm -3mm -4mm -5mm -6mm -8mm | Estuche Clipster

Pcs : 6 **23,27 €**

**10864070001**

EAN : 3221912022851  
**8 brocas madera TECHNIC de Ø2 a 10mm**

Ø2mm -3mm -4mm -5mm -6mm -7mm -8mm -10 mm | Estuche Clipster

Pcs : 8 **38,99 €**

**10863870002**

EAN : 3221912107138  
**5 brocas madera 3 puntas graduadas de Ø2 a 8mm (blíster)**

Ø2mm -2,5mm -3mm -4mm -5mm

Pcs : 5 **9,34 €**

**10863870016**

EAN : 3221910840525  
**6 brocas madera 3 puntas graduadas de Ø2 a 8mm**

Ø2mm -3mm -4mm -5mm -6mm -8mm | Estuche Clipster

Pcs : 6 **13,40 €**

**10863870014**

EAN : 3221910840501  
**7 brocas madera 3 puntas graduadas de Ø2 a 10mm**

Ø2mm -3mm -4mm -5mm -6mm -7mm -8mm -10mm | Estuche Clipster

Pcs : 8 **20,50 €**

**10863870003**

EAN : 3221910849405  
**9 brocas madera 3 puntas graduadas de Ø2 a 12mm**

Ø2mm -3mm -4mm -5mm -6mm -7mm -8mm -10mm -12mm | Estuche Ranger

Pcs : 9 **30,32 €**

**10804170005**

EAN : 3221912072139  
**6 brocas madera 3 puntas de Ø2 a 8mm**

Ø2mm -3mm -4mm -5mm -6mm -8mm | Estuche Clipster

Pcs : 6 **10,71 €**

**10804170004**

EAN : 3221912072122  
**8 brocas madera 3 puntas de Ø2 a 10mm**

Ø2mm -3mm -4mm -5mm -6mm -7mm -8mm -10mm | Estuche Clipster

Pcs : 8 **16,07 €**

**10803770002**

EAN : 3221912161710  
**5 brocas madera 3 puntas de Ø3 a 8mm mango hexagonal Shock Series**

Ø3mm -4mm -5mm -6mm -8mm | Estuche Clipster

Pcs : 5 **18,39 €**

**10803770001**

EAN : 322191086617  
**5 brocas madera 3  
 puntas de Ø3 a 8mm  
 mango hexagonal**

Ø3mm -4mm -5mm -6mm -8mm

Pcs : 5 **6,68 €**

**10802770001**

EAN : 3221912013187  
**6 brocas madera con 4  
 filos de Ø12 a 32mm  
 HEXA**

Ø12mm -14mm -16mm -22mm -25mm  
 -32mm

Pcs : 6 **82,42 €**

**10802570001**

EAN : 3221912283290  
**6 brocas para madera  
 planas de Ø14 a 24mm**

Ø14-16-18 -20-22-24mm

Pcs : 6 **29,00 €**

**50800370006**

EAN : 3221910018115  
**5 brocas madera 3  
 puntas de Ø4 a 10mm**

Ø4mm -5mm -6mm -7mm -8mm  
 -9mm -10mm

Pcs : 5 **6,47 €**

**10802470002**

EAN : 3221912263124  
**15 piezas: 9 brocas  
 madera 3 puntas de Ø2 a  
 10mm + 6 planas de Ø14  
 a 24mm**

Broca madera 3 puntas Ø2mm -2,5mm  
 -3mm -4mm -5mm -6mm -7mm -8mm  
 -10 mm / Broca madera plana  
 extracorta Ø14mm -16mm -18mm  
 -20mm -22mm -24mm | Estuche  
 Ranger

Pcs : 15 **70,17 €**

**50800370005**

EAN : 3221910018108  
**8 brocas madera 3  
 puntas de Ø3 a 10mm**

Ø3mm -4mm -5mm -6mm -7mm  
 -8mm -9mm -10mm

Pcs : 8 **9,58 €**

**10802470001**

EAN : 3221912040220  
**15 piezas: 8 brocas  
 madera 3 puntas de Ø3 a  
 10mm + 6 brocas planas  
 de Ø12 a 22mm**

Broca madera 3 puntas Ø3mm -4mm  
 -5mm -6mm -7mm -8mm -9mm  
 -10mm / Broca madera plana  
 extracorta Ø12mm -14mm -16mm  
 -18mm -20mm -22mm | Estuche  
 Ranger

Pcs : 15 **32,61 €**

**50800370001**

EAN : 3221910850852  
**8 brocas madera 3  
 puntas de Ø3 a 10mm  
 (blister)**

Ø3mm -4mm -5mm -6mm -7mm  
 -8mm -9mm -10mm

Pcs : 8 **4,18 €**

**10802720001**

EAN : 3221912013170  
**4 piezas: 3 brocas  
 madera con 4 filos de  
 Ø20 a 25mm + extensión**

Ø20mm -22mm -25mm + extensión  
 150mm | Blister

Pcs : 4 **47,36 €**

**50800870001**

EAN : 3221910847920  
**5 brocas madera planas  
 de Ø10 a 25mm (blister)**

Ø10mm -12mm -16mm -18mm -20mm  
 -25mm

Pcs : 6 **16,16 €**

**11102370001**

EAN : 3221910882051

**8 piezas: 1 tope de  
colocación tarimas + 2  
brocas madera + 4  
puntas + llave**1 tope colocación tarima / 1 llave  
Allen / 2 brocas madera Ø3mm / 4  
puntas de atornillado PZ2/2 - TX 20  
-25 | Blister

Pcs : 8

**51,73 €**

111009

**Guía de taladrado broca DIAMANTE al AGUA**

 L **1110092** Enganche plástico

CODE	EAN	Dim.	PCB	Qty	€ HT
11100920003	3221910900052	5>15	1	1	10,53
11100920004	3221910900069	/L	1	1	10,53

**11100820001**

 EAN : 3221910004415  
**Alargador de brocas  
 planas | L300mm | Mango  
 Hexagonal**

L300mm Ø14mm

Pcs : 1 **12,33 €**
**1111820001**

 EAN : 3221912053756  
**Aceite de corte  
 BIODEGRADABLE 70%**

1 aceite de corte Biodegradable

Pcs : 1 **8,69 €**



**11900670001**

EAN : 3221912000040

**3 Brocas/Fresas  
Ø3-4-5mm**

Ø3mm -4mm -5mm

Pcs : 3

**28,15 €****11900670002**

EAN : 3221912117489

**8 piezas: BROCAS/  
FRESAS 2 brocas madera  
+ 2 avellanadores + Accs.**Brocas Ø3mm -4mm / 2  
avellanadores / Puntas de atornillado  
PZ2 - TX25 / 1 portapuntas / 1 llave  
Allen

Pcs : 8

**23,16 €**

**11900170033**

EAN : 3221912117465  
**8 piezas: 4 machos HSS GUN DIN STEAM de M4 a M8 + 7 brocas HSS**

4 machos HSS DIN352 GUN Steam de M4 a M8 + 4 brocas HSS | Estuche TF4

Pcs : 8 **25,92 €**

**11900970017**

EAN : 3221912113764  
**29 piezas: 12 machos + 6 cojinetes de M3 a M12 + 2 GM + 1 PC 25,4 + Acc. | TECHNIC**

12 machos DIN352 + 12 cojinetes 25,4 M3 M4 M5 M6 MF8x100 M8 MF10x100 M10 MF12x125 M12x175 M12 + 2 giramachos + 1 porta -cojinetes 25,4 + Accesorio | Estuche MTF29

Pcs : 29 **69,40 €**

**11900870016**

EAN : 3221912113757  
**23 piezas: MÉTRICA 6 machos + 6 cojinetes de M3 a M10 + 2 GM + 1 PC 25,4 + 6 brocas cobalto + Acc.**

6 machos HSS DIN352 + 6 cojinetes HSS 25,4 M3 -M4 -M5 -M6 -M8 -M10 + 2 giramachos + 1 porta -cojinetes 25,4 + 6 brocas HSS Cobalto + Accesorios | Estuche MTF23

Pcs : 23 **143,14 €**

**11900970019**

EAN : 3221912233769  
**39 piezas: 17 machos + 17 cojinetes de M3 a M12 & MF4 a MF12 + 1 juego de galgas + 1 destornillador + 1 GM + 1 PC**

17 machos 1 paso en acero al carbono + 17 cojinetes en acero al carbono M3x50 MF3x60 M4x70 MF4x75 M5x80 MF5x90 MF6x75 M6x100 MF7x75 M7x100 MF8x100 M8x125 MF10x125 M10x150 MF12x150 M12x175 NPT1/8" + 1 juego de galgas + 1 destornillador + 2 porta -machos + 1 porta -cojinetes | Estándar | Estuche MTF39

Pcs : 39 **60,91 €**

**11900870017**

EAN : 3221912113771  
**29 piezas: MÉTRICA y MÉTRICA FIN 12 machos + 12 cojinetes de M3 a M12 + MF8 a MF12 + 2 GM + 1 PC 25,4 + Acc.**

12 machos HSS DIN352 + 12 cojinetes HSS 25,4 M3 M4 M5 M6 MF8x100 M8 MF10x100 M10 MF12x125 M12x175 M12 + 2 giramachos + 1 porta -cojinetes 25,4 + Accesorio | Estuche MTF29

Pcs : 29 **206,03 €**

**11900970018**

EAN : 3221912233752  
**21 piezas: 9 machos de M3 a M12 + 9 cojinetes de M3 a M12 + 1 destornillador + 1 GM + 1 PC | STANDARD**

9 machos 1 paso en acero al carbono + 9 cojinetes en acero al carbono M3x50 M4x70 M5x80 M6x100 M7x100 M8x125 M10x150 M12x175 NPT1/8" + 1 destornillador + 1 porta -machos + 1 porta -cojinetes | Estuche MTF21

Pcs : 21 **40,26 €**

**11900970015**

EAN : 3221912057563  
**19 piezas: 6 machos GUN DIN DIN + 6 cojinetes de M3 a M10 + 1 GM + 6 brocas TiN**

6 machos GUN DIN352 Steam 1 paso M3 -M4 -M5 -M6 -M8 -M10 + 6 cojinetes Hexa DIN13 M3 -M4 -M5 -M6 -M8 -M10 + 1 giramachos T BAR + 6 brocas HSS TiN DIN38 punta en cruz Ø2,5 -3,3 -4,2 -5 -6,8 -8,5mm | Estuche MTF19

Pcs : 19 **46,80 €**

**11901170052**

EAN : 3221912132116  
**10 extractores de clavos | TECHNIC**

Brocas + extractores N°1: Ø2,5 / N°2: Ø3,2 / N°3: Ø4,8 / N°4: Ø6,5 / N°5: Ø8 mm | Estuche Clispter

Pcs : 10 **28,81 €**

**11901170054**

EAN : 3221912218384  
**20 brocas mixtas  
 multimaterial**

7 brocas metal HSS rectificadas Oro  
 afilado punta en cruz Ø3 -3,5 -4 -4,5 -5  
 -6 -8mm + 4 brocas hormigón Extra  
 plaquita de carburo Ø4 -5 -6 -8mm + 3  
 brocas embaldosado plaquita de  
 carburo afilado especial Ø5 -6 -8mm +  
 2 brocas gres cerámico Diamante Ø6  
 -8 mm + 4 brocas madera 3 puntas Ø3  
 -4 -5 -6mm | Estuche RANGER T20  
 MIXTO

Pcs : 20

**43,35 €****11901170057**

EAN : 3221912242846  
**16 piezas: Mixto 100%  
 taladrado, 6 brocas metal  
 + 5 brocas madera + 4  
 brocas hormigón**

6 brocas metal HSS TiN Ø2 -3 -4 -5 -6  
 -8mm + 5 brocas madera 3 puntas Ø3  
 -4 -5 -6 -8mm + 4 brocas hormigón  
 Extra Ø4 -5 -6 -8mm + 1 avellanador  
 90° hexa 6,35 | Estuche RANGER T16  
 MIXTO

Pcs : 16

**25,29 €****11901170060**

EAN : 3221912250353  
**60 piezas para taladrado  
 multimaterial y  
 atornillado**

8 brocas metal TiN Ø2 -2,5 -3 -3,5 -4  
 -5 -6 -8mm + 7 brocas madera 3  
 puntas Ø2 -2,5 -3 -3,5 -4 -5 -6 -8mm +  
 4 brocas madera planas Ø14 -20 -22  
 -24mm + 4 brocas 2en1  
 "hormigón+embaldosado" Ø4 -5 -6  
 -8mm + 1 avellanador 90° + 1  
 portapuntas magnético Hexa + 1  
 portapuntas doble entrada + 4 llaves  
 de vaso Hexa Ø8 -8 -10 -13mm + 20  
 puntas de atornillado L25mm SQ2 -3 +  
 PZ1 -2 -2 -3 + PH1 -2 -2 -3 + Hexa2  
 -2,5 -3 -4 + TX10 -15 -20 -15 -30 -40 +  
 10 puntas de atornillado L50mm PS1  
 -2 -3 + PH1 -2 -3 + TX15 -20 -25 -30

Pcs : 60

**53,90 €****11901170034**

EAN : 3221910853556  
**30 piezas: 6 b.metal Ø2 a  
 6mm / 5 b.madera Ø3 a  
 8mm / 5 b.hormigón Ø4 a  
 8mm / 8 puntas  
 atornillado / 5 vasos Ø6 a  
 13mm / 1 PP**

6 brocas metal TiN Ø2>6mm + 5  
 brocas madera STD Ø3>8mm + 5  
 brocas hormigón PRO de Ø4 a 8mm +  
 8 puntas PH -PZ -TX + 5 llaves de  
 vaso de 6 a 13mm + 1 portapuntas  
 magnético | Maletín T30 MIXTO

Pcs : 30

**26,53 €****11901170049**

EAN : 3221912040176  
**35 piezas: Taladrado  
 Atornillado HEXA 6,35mm  
 7 b.metal TiN Ø2>8mm /  
 7 b.madera Ø3>8mm / 5  
 b.hormigón Ø3>8mm / 15  
 puntas atornillado / 1 PP  
 magnético**

7 brocas metal HSS TiN HEXA afilado  
 punta en cruz Ø2 -2,5 -3 -3,5 -4 -5  
 -6mm + 7 brocas madera 3 puntas  
 HEXA Ø2 -2,5 -3 -4 -5 -6 -8mm + 5  
 brocas hormigón Extra HEXA Ø3 -4 -5  
 -6 -8mm + 15 puntas PZ1 -PZ2 -PZ3  
 -PH1 -PH2 -PH3 -T15 -T20 -T25 -T30  
 -Hex4 -Hex5 -Hex6 -SI4 -SI6 + 1  
 portapuntas magnético Quick Change |  
 Maletín T38 MIXTO HEXA

Pcs : 38

**37,63 €****11901170043**

EAN : 3221910900403  
**20 piezas brocas Hexa: 5  
 b.metal Ø2 a 5mm / 3  
 b.madera Ø3 a 5mm / 3  
 b.hormigón Ø5 a 8mm / 8  
 puntas atornillado / 1 PP  
 Quick Change**

5 brocas metal TiN HEXA de Ø2 a  
 5mm + 3 brocas madera STD HEXA de  
 Ø3 a 5mm + 3 brocas hormigón PRO  
 HEXA de Ø5 a 8mm + 8 puntas PH -PZ  
 -TX + 1 portapuntas Quick change |  
 Maletín T20 MIXTO HEXA

Pcs : 20

**20,17 €****11901170047**

EAN : 3221912040169  
**24 piezas: Mixto  
 Taladrado Atornillado**

6 brocas metal HSS punta en cruz Ø2  
 -3 -4 -5 -6 -8mm + 4 brocas hormigón  
 Extra plaquita carburo Ø4 -5 -6 -8mm  
 + 5 brocas madera 3 puntas Ø3 -4 -5  
 -6 -8mm + 8 puntas Hexa 6,35mm PZ1  
 PZ2x2 PZ3 PH1 PH2x2 PH3 + 1  
 portapuntas magnético L60mm |  
 Estuche RANGER

Pcs : 24

**28,03 €****91901170001**

EAN : 3221910520441  
**16 piezas: Lote de 3  
 estuches brocas | Metal,  
 hormigón , madera |  
 ESTÁNDAR**

6 brocas metal STD Ø2>8 mm + 5  
 brocas hormigón STD de Ø4 a 10mm +  
 5 brocas madera STD de Ø4 a 10mm

Pcs : 16

**17,00 €**

111181

**DRILL DOCTOR 750**



└ **1111817** Estuche

CODE	EAN	Dim.	PCB	Qty	€ HT
111117750M	3221910866655	DD750	1	1	427,41



111180

**DRILL DOCTOR 500**



└ **1111807** Estuche

CODE	EAN	Dim.	PCB	Qty	€ HT
1111177500M	3221910864699	DD500	1	1	346,10



111117

**DRILL DOCTOR 400**



└ **1111177** Estuche

CODE	EAN	Dim.	PCB	Qty	€ HT
1111177400B	3221912009913	DD400	1	1	167,05





**11111720001**

EAN : 3221910857806  
**Muela para DRILL  
 DOCTOR | Grano 180**

Pcs : 1 **64,03 €**

**11111720004**

EAN : 3221910879723  
**Muela para DRILL  
 DOCTOR | Grano 100**

Pcs : 1 **74,07 €**

**11111720002**

EAN : 3221910857813  
**Portabrocas para DRILL  
 DOCTOR**

Pcs : 1 **126,26 €**



**TECHNIC | Macho máquina GUN | Acero rápido | Conicidad Inversa (blíster)**

**1050072** Blister

CODE	EAN	Dim.	PCB	Qty	€ HT
1050072030050	3221910035020	3*50	1	1	10,87
1050072040070	3221910035037	4*70	1	1	10,87
1050072050080	3221910035044	5*80	1	1	11,10
1050072060100	3221910035051	6*100	1	1	11,61
1050072080125	3221910035075	8*125	1	1	13,69
1050072100150	3221910035082	10*150	1	1	17,88
1050072120175	3221910035099	12*175	1	1	22,72



**1050074** Funda plástico

CODE	EAN	Dim.	PCB	Qty	€ HT
1050074030050	3221910079659	3*50	1	1	10,87
1050074040070	3221910079666	4*70	1	1	10,87
1050074050080	3221910079673	5*80	1	1	11,10
1050074060100	3221910079680	6*100	1	1	11,61
1050074080125	3221910079703	8*125	1	1	13,69
1050074100150	3221910079710	10*150	1	1	17,88
1050074120175	3221910079727	12*175	1	1	22,72



**Macho máquina HSS | Recto | MÉTRICA | Mango hexagonal (funda)**

**1050304** Funda plástico

CODE	EAN	Dim.	PCB	Qty	€ HT
1050304030050	3221910881788	3x50	1	1	5,86
1050304040070	3221910881795	4x70	1	1	5,86
1050304050080	3221910881801	5x80	1	1	5,86
1050304060100	3221910881818	6x100	1	1	5,86
1050304080125	3221910881825	8x125	1	1	7,22
1050304100150	3221910881832	10x150	1	1	7,95



**Broca roscadora y fresadora | MÉTRICA | Acero rápido | Mango hexagonal (blíster)**

**1050292** Blister

CODE	EAN	Dim.	PCB	Qty	€ HT
1050292040070	3221910879860	4x70	1	1	15,15
1050292050080	3221910879877	5x80	1	1	15,15
1050292060100	3221910881986	6x100	1	1	15,15



**1050294** Funda plástico

CODE	EAN	Dim.	PCB	Qty	€ HT
1050294030050	3221910881597	3x50	1	1	10,98
1050294040070	3221910881993	4x70	1	1	10,98
1050294050080	3221910882006	5x80	1	1	10,98
1050294060100	3221910881627	6x100	1	1	10,98
1050294080125	3221910881634	8x125	1	1	12,77
1050294100150	3221910881641	10x150	1	1	14,23



**105005**

**TECHNIC | Juego de 3 machos de mano HSS ISO**



**1050052** Blister

CODE	EAN	Dim.	PCB	Qty	€ HT
1050052030050	3221910004583	3*50	1	3	13,99
1050052040070	3221910004606	4*70	1	3	14,83
1050052050080	3221910004620	5*80	1	3	15,23
1050052060100	3221910004644	6*100	1	3	16,09
1050052080125	3221910004668	8*125	1	3	17,93
1050052100150	3221910004682	10*150	1	3	21,11
1050052120175	3221910004705	12*175	1	3	24,61



**Juego de 3 machos de mano | Métrica estándar | Acero cromado**

**1050012** Blister

CODE	EAN	Dim.	PCB	Qty	€ HT
1050012030050	3221910004439	3*50	1	3	9,42
1050012040070	3221910004453	4*70	1	3	9,60
1050012050080	3221910004477	5*80	1	3	9,89
1050012060100	3221910004491	6*100	1	3	10,59
1050012080125	3221910004514	8*125	1	3	13,16
1050012100150	3221910004538	10*150	1	3	17,55
1050012120175	3221910004552	12*175	1	3	22,11



**10503070001**

EAN : 3221910881849  
**7 piezas: 6 machos de M3 a M10 con mango hexagonal 1/4" + 1 PP**

HSS mango HEXA 1/4" M3 -M4 -M5 -M6 -M8 -M10 + 1 portapuntas | Estuche THD

Pcs : 7 **47,62 €**

**10502970001**

EAN : 3221910881658  
**7 piezas: 6 brocas de roscado y fresado de M3 a M10 + 1 PP**

HSS mango HEXA 1/4" M3 -M4 -M5 -M6 -M8 -M10 + 1 portapuntas | Estuche FTH

Pcs : 7 **91,31 €**



**111001**  
**Portamachos (blíster)**

**1110012**

CODE	EAN	Dim.	PCB	Qty	€ HT
11100120110	3221910007492	N°1	1	1	13,33
11100120412	3221910007508	N°2	1	1	20,06





11100120001

EAN : 3221910880415

**Portamachos de ØM3 a M11**

M3 -M10 Ø2,5 -5,5mm

Pcs : 1

**17,90 €**

110001

**EXTRA | Cojinetes acero cromado |  
Diám. 25,4**



└ **1100012** Blister

CODE	EAN	Dim.	PCB	Qty	€ HT
1100012030050	3221910003661	3*50	1	1	14,19
1100012040070	3221910003685	4*70	1	1	14,23
1100012050080	3221910003708	5*80	1	1	14,23
1100012060100	3221910003722	6*100	1	1	14,23
1100012080125	3221910003746	8*125	1	1	14,23
1100012100150	3221910003760	10*150	1	1	14,23







**Porta cojinetes (granel)**

1110042 Blister

CODE	EAN	Dim.	PCB	Qty	€ HT
11100420254	3221910004392	25,4	1	1	9,93





**1036132** Blister

**1036132**

CODE	EAN	Dim.	PCB	Qty	€ HT
10361320205	3221910222871	2-5	1	1	17,31
10361320510	3221910222888	5-10	1	1	20,90
10361321015	3221910222895	10-15	1	1	36,22
10361321520	3221910222901	15-20	1	1	61,87



**1033162** Blister

**1033162**

CODE	EAN	Dim.	PCB	Qty	€ HT
10331620630	3221910222918	6,3	1	1	12,41
10331620800	3221910222925	8	1	1	13,72
10331620830	3221910222932	8,3	1	1	13,94
10331621000	3221910222949	10	1	1	16,24
10331621040	3221910222956	10,4	1	1	16,85
10331621150	3221910222963	11,5	1	1	17,67
10331621240	3221910222970	12,4	1	1	17,91
10331621500	3221910222987	15	1	1	20,55
10331621650	3221910222994	16,5	1	1	22,06
10331621900	3221910223007	19	1	1	22,06
10331622050	3221910223014	20,5	1	1	29,89
10331622500	3221910223021	25	1	1	39,14
10331620430	3221912208934	4,3	1	1	12,13
10331620530	3221912208941	5,3	1	1	12,13
10331620940	3221912208958	9,4	1	1	15,35
10331621340	3221912208965	13,4	1	1	19,16
10331622300	3221912208972	23	1	1	30,57
10331623100	3221912208989	31	1	1	61,73



**1033234** Blister

**1033234**

CODE	EAN	Dim.	PCB	Qty	€ HT
10332340630	3221910881917	6,3	1	1	8,06
10332340830	3221910881924	8,3	1	1	9,24
10332341040	3221910881931	10,4	1	1	10,57
10332341240	3221910881948	12,4	1	1	12,42
10332341650	3221910881955	16,5	1	1	17,22
10332342050	3221910881962	20,5	1	1	22,51



**XT60122** Blister

**XT60122**

CODE	EAN	Dim.	PCB	Qty	€ HT
XT60612045217	3128820452179	12	3	1	7,88
XT60612045218	3128820452186	20	3	1	10,80



**XT60012** Blister

**XT60012**

CODE	EAN	Dim.	PCB	Qty	€ HT
XT60612045214	3128820452148	10	3	1	4,76
XT60612045215	3128820452155	12	3	1	4,76
XT60612045216	3128820452162	16	3	1	5,10
XT60612045205	3128820452056	19	3	1	5,47



**10331670006**

EAN : 3221912117441  
**5 piezas: 4 fresas rotativas 90° de Ø8,3 a 16,5mm + 1 avellanador con agujero**

HSS E Ø8,3mm -10,4mm -12,4mm -16,5mm + 1 avellanador de 5 a 10mm | Estuche FNH04

Pcs : 5 **74,69 €**



**10331670005**

EAN : 3221910899455  
**6 avellanadores HSSE 90° de Ø6,3 a 20,5mm**

Ø6,3mm -8,3mm -10,4mm -12,4mm -16,5mm -20,5mm | Estuche FNH06

Pcs : 6 **107,99 €**



**10332370002**

EAN : 3221912117434  
**5 piezas: 4 fresas rotativas HSS 90° de Ø8,3 a 16,5mm con mango hexa 1/4" + 1 PP**

HSS mango HEXA 1/4" Ø8,3mm -10,4mm -12,4mm -16,5mm +1 portapuntas | Estuche FNH04

Pcs : 7 **54,11 €**



**10332370001**

EAN : 3221910881979  
**7 piezas: 6 fresas rotativas 90° de Ø6,3 a 20,5mm + 1 PP**

HSS mango HEXA 1/4" Ø6,3mm -8,3mm -10,4mm -12,4mm -16,5mm -20,5mm + 1 portapuntas | Estuche FNH06

Pcs : 6 **78,05 €**



**103163 Fresa lima carburo | Cilíndrico al final | Forma D | Rompevirutas**

└ **1031632** Blister

CODE	EAN	Dim.	PCB	Qty	€ HT
10316320600	3221910837242	6	1	1	30,45
10316320800	3221910837259	8	1	1	36,57
10316321000	3221910837266	10	1	1	41,32
10316321200	3221910837273	12	1	1	55,27



**103165 Fresa lima metal duro | Cilíndrica con radio | Forma D rompevirutas**

└ **1031652** Blister

CODE	EAN	Dim.	PCB	Qty	€ HT
10316520600	3221910837280	6	1	1	30,15
10316520800	3221910837297	8	1	1	37,71
10316521000	3221910837303	10	1	1	43,28
10316521200	3221910837310	12	1	1	61,70



**103179 Fresa lima metal duro | Ojiva | Forma D rompevirutas**

└ **1031792** Blister

CODE	EAN	Dim.	PCB	Qty	€ HT
10317920600	3221910837327	6	1	1	34,33
10317920800	3221910837334	8	1	1	35,20
10317921000	3221910837341	10	1	1	41,61
10317921200	3221910837358	12	1	1	48,90



**103183 Fresa lima metal duro | Ovalado con radio | Forma D rompevirutas**

└ **1031832** Blister

CODE	EAN	Dim.	PCB	Qty	€ HT
10318320600	3221910837365	6	1	1	35,73
10318320800	3221910837372	8	1	1	37,14
10318321000	3221910837389	10	1	1	44,14
10318321200	3221910837396	12	1	1	52,77



**103185 Fresa lima metal duro | Esférica | Forma D rompevirutas**

└ **1031852** Blister

CODE	EAN	Dim.	PCB	Qty	€ HT
10318520600	3221910837402	6	1	1	30,15
10318520800	3221910837419	8	1	1	31,57
10318521000	3221910837426	10	1	1	36,57
10318521200	3221910837433	12	1	1	44,14



**10316070008**

EAN : 3221912117458  
**5 fresas rotativas metal  
duro Ø8mm | Mango de  
6mm**

Fresas lima rotativas metal duro Ø8mm  
| Estuche FLK08

Pcs : 5

**88,81 €**





**INOX TORSIÓN | Puntas de atornillado | Para tornillos Pozidriv (blíster)**

**1152422** Blister

CODE	EAN	Dim.	PCB	Qty	€ HT
11524220001	3221912006233	N1-2-3	1	3	10,01
11524220200	3221910868178	N2	1	1	5,01



**INOX TORSIÓN | Puntas de atornillado | Para tornillos Phillips (blíster)**

**1152432** Blister

CODE	EAN	Dim.	PCB	Qty	€ HT
11524320001	3221912006257	N1-2-3	1	3	10,01
11524320200	3221910868352	N2	1	1	5,01



**INOX TORSIÓN | Puntas de atornillado | Para tornillos Torx (blíster)**

**1152452** Blister

CODE	EAN	Dim.	PCB	Qty	€ HT
11524520002	3221912006288	N10-15-20	1	3	11,26
11524520001	3221912006271	N20-25-30	1	3	11,26
11524522000	3221910868277	N20	1	1	5,52
11524522500	3221910868284	N25	3	1	5,52
11524523000	3221910868291	N30	3	1	5,52



**IMPACT DIAMOND TORSIÓN | Puntas de atornillado Pozidriv**

**1152322** Blister

CODE	EAN	Dim.	PCB	Qty	€ HT
11523220001	3221910867904	N1-2-3	1	3	7,88
11523220100	3221910867911	N1	1	1	3,77
11523220200	3221910867928	N2	1	1	3,77
11523220300	3221910867935	N3	3	1	3,77



**IMPACT DIAMANTE TORSIÓN | Puntas de atornillado | Para tornillos Pozidriv**

**1152372** Blister

CODE	EAN	Dim.	PCB	Qty	€ HT
11523720001	3221912087331	N1-2-3	1	3	10,35
11523720200	3221912087386	N2	1	1	4,95



**IMPACT DIAMANTE TORSIÓN | Puntas de atornillado | Para tornillos Phillips**

**1152332** Blister

CODE	EAN	Dim.	PCB	Qty	€ HT
11523320001	3221910867973	N1-2-3	1	3	7,88
11523320100	3221910867980	N1	1	1	3,77
11523320200	3221910867997	N2	1	1	3,77
11523320300	3221910868000	N3	3	1	3,77



**IMPACT DIAMOND TORSIÓN | Puntas de atornillado | Para tornillos Phillips**

**1152382** Blister



CODE	EAN	Dim.	PCB	Qty	€ HT
11523820001	3221912087409	N1-2-3	1	3	10,35
11523820200	3221912087416	N2	1	1	4,95



**IMPACT DIAMANTE TORSIÓN | Puntas de atornillado | Para tornillos Torx**

**1152352** Blister

CODE	EAN	Dim.	PCB	Qty	€ HT
11523521000	3221910868079	N10	3	1	4,56
11523521500	3221910868086	N15	3	1	4,56
11523522000	3221910868093	N20	3	1	4,56
11523522500	3221910868109	N25	3	1	4,56
11523523000	3221910868116	N30	3	1	4,56
11523524000	3221910868123	N40	3	1	4,56



**IMPACT DIAMANTE TORSIÓN | Puntas de atornillado | Para tornillos Torx**

**1152342** Blister

CODE	EAN	Dim.	PCB	Qty	€ HT
11523422000	3221912087294	N20	1	1	5,97
11523422500	3221912087300	N25	1	1	5,97
11523423000	3221912087317	N30	1	1	5,97
11523424000	3221912087324	N40	1	1	5,97



**TORSIÓN TIN | Puntas de atornillado | Para tornillos Pozidriv (blíster)**

**1152222** Blister

CODE	EAN	Dim.	PCB	Qty	€ HT
11522220001	3221910867522	N1-2-3	1	3	7,16
11522220100	3221910867539	N1	3	1	2,90
11522220200	3221910867546	N2	3	1	2,90
11522220300	3221910867553	N3	3	1	2,90



**1152226** Blister

CODE	EAN	Dim.	PCB	Qty	€ HT
11522260200	3221910896331	N2	3	10	11,96



**TORSIÓN TIN | Puntas de atornillado | Para tornillos Pozidriv**

**1152272** Blister

CODE	EAN	Dim.	PCB	Qty	€ HT
11522720200	3221910867799	N2	3	1	3,90
11522720001	3221912061188	N1-2-3	1	3	8,10



**TORSIÓN TIN | Puntas de atornillado | Para tornillos Phillips (blíster)**

**1152232** Blister

CODE	EAN	Dim.	PCB	Qty	€ HT
11522320001	3221910867591	N1-2-3	1	3	6,00
11522320100	3221910867607	N1	3	1	2,90
11522320200	3221910867614	N2	3	1	2,90
11522320300	3221910867621	N3	3	1	2,90



**1152236** Blister

CODE	EAN	Dim.	PCB	Qty	€ HT
11522360200	3221910896348	N2	3	10	11,96



**TORSIÓN TIN | Puntas de atornillado | Para tornillos Phillips**

1152282 Blister

CODE	EAN	Dim.	PCB	Qty	€ HT
11522820200	3221910867850	N2	3	1	3,90
11522820001	3221912061195	N1-2-3	1	3	8,10



115225

TORSIÓN TIN | Puntas de atornillado | Para tornillos Torx

1152252 Blister

CODE	EAN	Dim.	PCB	Qty	€ HT
11522521000	3221910867690	N10	3	1	3,48
11522521500	3221910867706	N15	3	1	3,48
11522522000	3221910867713	N20	3	1	3,48
11522522500	3221910867720	N25	3	1	3,48
11522522700	3221912061119	N27	3	1	3,48
11522523000	3221910867737	N30	3	1	3,48
11522524000	3221910867744	N40	3	1	3,48



115224

EXTRA DURA TORSIÓN | Puntas de atornillado | Para tornillos Torx

1152242 Blister

CODE	EAN	Dim.	PCB	Qty	€ HT
11522420001	3221912108654	N10-15-20	1	3	8,10
11522420002	3221912108661	N25-30-40	1	3	8,10



115201

TORSIÓN | Puntas de atornillado | Para tornillos de ranura

1152012 Blister

CODE	EAN	Dim.	PCB	Qty	€ HT
11520120001	3221912107824	4,5-5,5-6,5	1	3	6,45



115202

TORSIÓN | Puntas de atornillado | Para tornillos Pozidriv

1152022 Blister

CODE	EAN	Dim.	PCB	Qty	€ HT
11520220001	3221910879785	N1-2-3	1	3	4,28
11520220100	3221910866990	N1	6	2	2,86
11520220200	3221910867003	N2	6	2	2,86
11520220300	3221910867010	N3	6	2	2,86



115207

TORSIÓN | Puntas de atornillado | Para tornillos Pozidriv

1152072 Blister

CODE	EAN	Dim.	PCB	Qty	€ HT
11520720001	3221912108630	N1-2-3	1	3	5,24
11520720100	3221910867263	N1	6	1	2,52
11520720200	3221910867270	N2	6	1	2,52



115203

TORSIÓN | Puntas de atornillado | Para tornillos Phillips

1152032 Blister

CODE	EAN	Dim.	PCB	Qty	€ HT
11520320001	3221910879792	N1-2-3	1	3	4,28
11520320100	3221910867058	N1	6	2	2,86
11520320200	3221910867065	N2	6	2	2,86
11520320300	3221910867072	N3	6	2	2,86



115208

TORSIÓN | Puntas de atornillado | Para tornillos Phillips

1152082 Blister

CODE	EAN	Dim.	PCB	Qty	€ HT
11520820001	3221912108647	N1-2-3	1	1	5,24
11520820100	3221910867324	N1	6	1	2,52
11520820200	3221910867331	N2	6	1	2,52



115205

TORSIÓN | Puntas de atornillado | Para tornillos Torx

1152052 Blister

CODE	EAN	Dim.	PCB	Qty	€ HT
11520520001	3221910867157	N20-25-30	1	3	5,04
11520520002	3221912108623	08/01/1900	1	3	5,04
11520521000	3221910867164	N10	6	1	2,43
11520521500	3221910867171	N15	6	1	2,43
11520522000	3221910867188	N20	6	1	2,43
11520522500	3221910867195	N25	6	1	2,43
11520523000	3221910867218	N30	6	1	2,43
11520524000	3221910867225	N40	6	1	2,43



115204

TORSIÓN | Puntas de atornillado | Para tornillos Torx

1152042 Blister

CODE	EAN	Dim.	PCB	Qty	€ HT
11520422000	3221910868413	N20	6	1	2,52
11520422500	3221910868420	N25	6	1	2,52
11520423000	3221910868437	N30	6	1	2,52



115206

HEXA PLUS | Puntas de atornillado | Para tornillos Allen

1152062 Blister

CODE	EAN	Dim.	PCB	Qty	€ HT
11520620001	3221912107800	3/4/5	1	3	5,11



115209

HEXA PLUS | Puntas de atornillado | Para tornillos Torx

1152092 Blister

CODE	EAN	Dim.	PCB	Qty	€ HT
11520920300	3221910867386	3	6	1	3,01
11520920400	3221910867393	4	6	1	3,01
11520920600	3221910867409	6	6	1	3,01



115107

ESTÁNDAR | Puntas de atornillado | Para tornillo Pozidriv

1151072 Blister

CODE	EAN	Dim.	PCB	Qty	€ HT
11510720001	3221910843151	N1-2	3	2	6,77



115108

ESTÁNDAR | Puntas de atornillado | Ppara tornillo Phillips

1151082 Blister

CODE	EAN	Dim.	PCB	Qty	€ HT
11510820001	3221910843168	N1-2	3	2	6,77



115105

ESTÁNDAR | Puntas de atornillado | Para tornillo Torx

1151052 Blister



CODE	EAN	Dim.	PCB	Qty	€ HT
11510520001	3221910843175	N25-30	3	2	7,11

115017



**Punta SEGURIDAD | Puntas de atornillado | Para tornillo Torx Tamper**

1150172 Blister

CODE	EAN	Dim.	PCB	Qty	€ HT
11501720001	3221910899707	N6-8-9	1	3	9,08
11501720002	3221912108593	N10-15-20	1	3	9,08
11501720003	3221912108609	N20-25-27	1	3	9,08
11501720004	3221912108616	N25-30-40	1	3	9,08



115306



**Punta SEGURIDAD | Puntas de atornillado | Para tornillo cuadrado**

1153062 Blister

CODE	EAN	Dim.	PCB	Qty	€ HT
11530620001	3221912107817	1-2-3	1	3	9,08



**11501520004**

EAN : 3221912006844  
**8 piezas puntas Torx | PRECISION (blíster)**

TX de 4mm: 4 -5 -6 -7 -8 -9 -10 -15

Pcs : 8 **5,83 €**



**11501560001**

EAN : 3221910793371  
**35 piezas: 10 puntas de atornillado + 1 PP (blíster)**

PZ 1 -2 / TX 10 -15 -20 -25 -30 -40 / PH 1 -2 / Reversible Ranura -PZ / 1 portapuntas magnético

Pcs : 35 **23,36 €**



**11501520001**

EAN : 3221912006813  
**7 piezas puntas Ranura | PRECISION (blíster)**

Ranura de 4mm: 0 -1,5 -2 -2,5 -3 -3,5 -4mm

Pcs : 7 **5,83 €**



**11501520002**

EAN : 3221912006820  
**8 piezas puntas PH/PZ | PRECISION (blíster)**

PH de 4mm: Ph000 -00 -0 -1 / PZ de 4mm: Pz000 -00 -0 -1

Pcs : 8 **5,83 €**



**11501520003**

EAN : 3221912006837  
**8 piezas puntas Allen | PRECISION (blíster)**

Allen de 4mm: 0,7 -0,9 -1,3 -1,5 -2 -2,5 -3 -4mm

Pcs : 8 **5,83 €**



**115219** **IMPACT | Llave de vaso magnética**

1152192 Blister

CODE	EAN	Dim.	PCB	Qty	€ HT
11521920600	3221910899486	6	3	1	15,61
11521920800	3221910899493	8	1	1	15,61
11521921000	3221910899509	10	1	1	18,65
11521921200	3221910899523	12	1	1	19,93
11521921300	3221910899530	13	1	1	19,93



1159242

CODE	EAN	Dim.	PCB	Qty	€ HT
11591120009	3221912196439	Réduc 3/8" > 1/4"	1	1	10,22
11591120010	3221912196453	Reduc 1/2" > 3/8"	1	1	13,31
11591120011	3221912196460	Adaptat 3/8" > 1/2"	1	1	13,31



**115019** **CLASSIC | Llave de vaso magnética**

1150192 Blister

CODE	EAN	Dim.	PCB	Qty	€ HT
11501920600	3221910115296	6	3	1	8,95
11501920700	3221910115302	7	3	1	8,95
11501920800	3221910115319	8	3	1	8,95
11501921000	3221910115333	10	3	1	8,95
11501921200	3221910115357	12	3	1	8,95
11501921300	3221910115364	13	3	1	8,95



**115914**

**Vasos de Impacto Allen 1/2"**



1159142 Caja blíster Box

CODE	EAN	Dim.	PCB	Qty	€ HT
11591421000	3221912196484	N10	1	1	6,40
11591421200	3221912196491	N12	1	1	6,40
11591421300	3221912196507	N13	1	1	6,40
11591421400	3221912196514	N14	1	1	6,40
11591421600	3221912196521	N16	1	1	6,61
11591421700	3221912196538	N17	1	1	6,61
11591421800	3221912196545	N18	1	1	6,61
11591421900	3221912196552	N19	1	1	6,61
11591422000	3221912196569	N120	1	1	7,43
11591422100	3221912196576	N21	1	1	7,43
11591422200	3221912196583	N22	1	1	7,43
11591422400	3221912196590	N24	1	1	7,74
11591422700	3221912196613	N27	1	1	8,78
11591423000	3221912196620	N30	1	1	11,87
11591423200	3221912196637	N32	1	1	12,91



**Vasos de Impacto largas**

1159012 Blister

CODE	EAN	Dim.	PCB	Qty	€ HT
11590125000	3221912196293	N50	1	1	11,56
11590125500	3221912196309	N55	1	1	11,56
11590126000	3221912196330	N60	1	1	12,18
11590127000	3221912196347	N70	1	1	12,18



**115911**

**KIT SEGURIDAD | Clavijas & juntas llaves de vaso**



1159112

CODE	EAN	Dim.	PCB	Qty	€ HT
11591120001	3221912196361	1/2" 8 à 16 mm	1	4	5,05
11591120002	3221912196378	1/2" 17 à 19 mm	1	4	5,05
11591120003	3221912196385	1/2" 21 à 32 mm	1	4	5,05



**115924**

**SCHOCK SERIES | Reductor 3/8">1/4"**



**11501920001**  
 EAN : 3221910899462  
**6 llaves de vaso de Ø1 a 8mm (blíster)**  
 Ø6mm -8mm x2 Ø10mm -12mm -13mm

Pcs : 6 **16,81 €**



**11591120004**  
 EAN : 3221912196392  
**Vaso portapuntas 6,35mm>1/2" | IMPACT**  
 Llave de vaso portapuntas 1/2 -1/4

Pcs : 1 **14,35 €**



**11591120006**  
 EAN : 3221912196415  
**Extensión L75mm 1/2">1/2"**

Pcs : 1 **9,18 €**



**11591120007**  
 EAN : 3221912196422  
**Extensión L150mm 1/2">1/2"**

Pcs : 1 **13,31 €**



**11591120012**EAN : 3221912196477  
**Cardán 1/2" > 1/2"**Pcs : 1 **25,70 €****11591120005**EAN : 3221912196408  
**Adaptador para vaso  
HEXA 6,35mm > 1/2"  
L73mm**Pcs : 1 **13,31 €****11501420001**EAN : 3221910207830  
**5 piezas: 4 llaves de vaso  
de Ø6 a 13mm + 1  
adaptador porta vasos  
(blíster)**Ø6mm-8mm-10mm-13mm + Porta  
cojinetes 1/4"Pcs : 5 **13,80 €****11501420002**EAN : 3221910820985  
**Llave de vaso universal  
(blíster)**Pcs : 3 **49,51 €****11521470001**EAN : 3221912109231  
**12 piezas: 9 vasos de  
impacto de Ø8 a 24mm +  
2 adaptadores + 1  
extensión**Ø8mm -10mm -13mm -14mm -16mm  
-17mm -19mm -21mm -24mm +  
Adaptadores 1/2 -1/4 y 1/4 -1/2 +  
Extensión 1/2 -1/2 75 mm | SHOCK  
SERIESPcs : 12 **58,03 €****11521470002**EAN : 3221912132093  
**10 piezas: 7 llaves de  
extracción de Ø10 a  
19mm + Accesorios**Ø10mm -11mm -13mm -14mm -16mm  
-17mm -19mm + Aumentador 1/2" +  
Portacojinetes + Barra de extracción |  
SHOCK SERIESPcs : 10 **66,95 €****11521470003**EAN : 3221912289193  
**Estuche 7 piezas | 5  
vasos de impacto de Ø13  
a 24 mm + 1 adaptador  
1/2" > 6,35mm + 1  
adaptador 6,35mm > 1/2"**5 vasos IMPACT: entrada cuadrada  
1/2" Ø13-17-19-21-24mm + 1  
adaptador cuadrado 1/2" > Hexa  
6,35mm + 1 Adaptador hexagonal  
6,35mm > 1/2" cuadrado.Pcs : 7 **36,50 €****11591170001**EAN : 3221912196644  
**6 piezas: Reductores y  
Aumentadores | SHOCK  
SERIES**3/4 -1/2 + 1/2 -3/4 + 1/2 -3/8 + 3/8  
-1/2 + 3/8 -1/4 + 1/4 -3/8Pcs : 6 **44,28 €****11591470001**EAN : 3221912196651  
**3 piezas: Llaves de  
impacto | Especial ruedas  
de coche**Llaves de vaso impacto largas 1/2"  
Ø17mm -19mm -21mm | SHOCK  
SERIESPcs : 3 **33,65 €**

**11522020003**

EAN : 3221910867430  
**10 puntas PZ2 TORSIÓN (blíster)**

PZ2 x10

Pcs : 10

**11,99 €****11522020001**

EAN : 3221910867416  
**10 puntas PH2 TORSIÓN (blíster)**

PH2 x10

Pcs : 10

**11,99 €****11522020012**

EAN : 3221910879754  
**10 puntas TX20 TORSIÓN (blíster)**

TX20 x10

Pcs : 10

**15,65 €****51501520001N**

EAN : 3221910206581  
**15 piezas: 14 puntas TiN + 1 porta puntas**

Ranura Ø4 -5 -6 -7 / PH 0 -1 -2 -3 / PZ 0 -1 -2 -3 / Reversible Ranura -PH Ø5 -2mm / Reversible Ranura -PZ Ø5 -2mm / 1 portapuntas

Pcs : 15

**13,42 €****11501570021**

EAN : 3221910862879  
**7 piezas: 6 puntas PH/PZ + 1 PP magnético**

PH 1 -2 -3 / PZ 1 -2 -3 / 1 portapuntas magnético | ENGANCHE CINTURÓN

Pcs : 7

**9,05 €****11501570022**

EAN : 3221910862886  
**9 piezas: 8 puntas TiN + 1 PP magnético**

Ranura 5,5 -6,5 / PH 1 -2 -3 / PZ 1 -2 -3 / 1 portapuntas magnético | ENGANCHE CINTURÓN

Pcs : 9

**16,44 €****11501570023**

EAN : 3221910862893  
**9 piezas: 8 puntas de atornillado + 1 PP magnético**

Ranura 5,5 -6,5 / PH 1 -2 -3 / PZ 1 -2 -3 / 1 portapuntas magnético | ENGANCHE CINTURÓN

Pcs : 9

**10,96 €****11501570024**

EAN : 3221910862909  
**7 piezas: 6 puntas TX + 1 PP magnético**

TX 10 -15 -20 -25 -30 -40 / 1 portapuntas magnético | ENGANCHE CINTURÓN

Pcs : 7

**12,94 €****11501570025**

EAN : 3221912006356  
**27 piezas MODELADO: 14 puntas + 5 llaves + 6 llaves de vaso + Extension + 1 PP | PRECISIÓN**

Soporte y varilla de extensión / 3 Ranura 2 -3 -4mm L50mm / 4 PH 0 -0 -1 -2 L50mm / 7 TX 5 -6 -7 -8 -9 -10 -15 / 5 llaves de boca simple 4,0 - 4,5 -5,0 -5,5 -6,0mm / 6 mini llaves de vaso 2,5 -3,0 -3,5 -4,0 -4,5 -5,0mm

Pcs : 27

**26,86 €****11501570026**

EAN : 3221910864521  
**35 piezas: 33 puntas de PRECISIÓN + 1 PP magnético + 1 destornillador**

7 Ranura 1 -1,5 -2 -2,5 -3 -3,5 -4 / 2 PZ 0,1 / 4 PH 000,00,0,1 / 8 Allen 0,7 -0,9 -1,3 -1,5 -2 -2,5 -3 -4 / 4 TX 4,5,6,7 / 5 TXTamper T8,9,10,15,20 / 1 Tri -Wing 3 / 1 Doble punta 2,6 / 1 Cuadrado 0 / 1 destornillador / 1 portapuntas magnético L100 mm

Pcs : 35

**20,93 €**

**11501570027**

EAN : 3128821845048  
**28 piezas: 15 puntas + 9 vasos + 1 PP magnético + Destornillador y acc. | ESTÁNDAR**

Ranura 5,5 / PH 1 -2 / PZ 1 -2 -3 / TXT 8 à 40 / Llaves de vaso 5 -6 -7 -8 -9 -10 -11 -12 -13 / 1 adaptador / 1 portapuntas magnético / 1 trinquete / 1 destornillador

Pcs : 28 **27,65 €**

**11501570039**

EAN : 3221912028327  
**25 piezas: 24 puntas anillo SEGURIDAD largas + 1 PP**

Ranura 4 -6 -8 -10 L50mm / TTX 20 -25 -27 -30 -40 L25mm / TTX 8 -10 -15 L50mm / Allen 4 -5 -6 L25mm / Allen 2 -2,5 -3 L50mm / Torqset 6 -8 -10 L50mm / 3 wing 1 -2 -3 L50mm + 1 portapuntas

Pcs : 25 **22,72 €**

**11501570028**

EAN : 3221910900380  
**17 piezas: 16 puntas anillo TORSIÓN + 1 PP magnético Quick Change**

PH 1 -2 -3 / Pz 1 -2 -3 / TX 10 -15 -20 -25 -30 / Allen 3 -4 -5 / Ranura 4 -6 / 1 portapuntas Quick Change magnético | Estuche CROC BOX

Pcs : 17 **19,20 €**

**11501570040**

EAN : 3221912040183  
**54 piezas: 53 puntas L25-50mm + 1 PP magnético**

Puntas L25mm: PZ0/PZ1/PZ2/PZ3/PH0/PH1/PH2/PH3/TX15/TX20/TX25/TX30/TTX10/TTX15/TTX20/TTX25/TTX27/TTX30/TTX40/SL3/SL4/SL5/SL6/Hex2 -2,5 -3 -4 -5 -5,5 -6/SQ1/SQ2/SQ3/SP6 -8 -10 + Puntas L50mm: PZ1/PZ2/PZ3/PH1/PH2/PH3/Hex2/Hex3/Hex4/Hex5/Hex6 + 1 portapuntas magnético L60mm

Pcs : 53 **28,47 €**

**11501570035**

EAN : 3221912016577  
**7 piezas: 6 puntas TiN PZ anillo TORSIÓN + 1 PP magnético**

1 portapuntas / PZ 2X3 / PZ 3X3 | Estuche Bbox

Pcs : 7 **17,30 €**

**11501570041**

EAN : 3221912066985  
**32 piezas: Puntas de atornillado y accesorios para SMARTPHONE Y TABLET**

Pentalobe 0,8 -0,8 -1,2 -1,5 / Tri -Point 0,6 / TorxTampoTTX 6 -6 / Ranura 1,5 -2 -2,5 / Hexa 1,5 -1,5 -2 / PH 000 -00 -0 -1 / Tri -Lobe(Torq -set) #0 | TX T4 -5 -6 -8 -10 / Triángulo TA30 (3mm) / 1 adaptador 6,35 / 1 mango de destornillador de precisión / 1 extensión / 1 pinza / 2 herramientas de apertura / 1 mediador / 1 ventosa para pantalla

Pcs : 32 **22,76 €**

**11501570036**

EAN : 3221912016584  
**7 piezas: 6 puntas TiN PH anillo TORSIÓN + 1 PP magnético**

1 portapuntas magnético / PH 1X3 / PH 2X3 | Estuche Bbox

Pcs : 7 **17,30 €**

**11501570042**

EAN : 3221912132086  
**57 piezas: Puntas de atornillado y accesorios para APERTURA SMARTPHONE**

Kit de 42 puntas : Pentalobe 0,8 -0,8 -1,2 -1,2 -1,5 -2mm / PH000 -PH000 -PH00 -PH0 -PH1 / U2,6 / TX3 -4 -5 -6 -8 -10/ TTX6 -7 -8 -9 -10 / Gamebit 3,8 -4,5mm/ TA 18 -20 -23 -27 -32 / SL1,5 -2 -2,5mm / H1,5 -1,5 -2 / Y000 -Y0 -Y1 / Elipse / Y0 -Y1 + 1 correa antiestática + 1 ventosa para pantalla + 5 herramientas de apertura + 2 mediadores + 1 tenazas + 1 espátula + 1 cuchilla + 1 mango de atornillado + 1 extensión + 1 extractor de tarjeta SIM | Maletín

Pcs : 57 **46,00 €**

**11501570038**

EAN : 3221912028310  
**17 piezas: 16 puntas anillo EXTRA LARGAS L120mm + 1 PP**

PZ 1 -2 L25mm / PZ 1 -2 L120mm / PH 1 -2 L25mm / PH 1 -2 L120mm / TX 10 -15 -20 -25 L25mm / TX 10 -15 -20 -25 L120mm + 1 portapuntas magnético L60mm

Pcs : 17 **18,35 €**



**11501570043**

EAN : 3221912134929  
**17 piezas: Puntas de atornillado y accesorios para APERTURA SMARTPHONE**

Pentalobe 0,8 -0,8 -1,2 -1,2 / Ranura 1,5 -2,0 / PH 000 - 00 / TX T3 -4 -5 -6 + 1 mango de destornillador de precisión + 2 herramientas de apertura + 1 ventosa para pantalla + 1 extractor de tarjeta SIM

Pcs : 17 **17,03 €****11501572003**

EAN : 3221912111722  
**35 piezas: 34 puntas ESTÁNDAR + 1 PP magnético Quick Change**

4 Ranura / 5 PZ / 5 PH / 8 TX / 8 TTX / 4 Hexa + 1 portapuntas Quick Change magnético

Pcs : 35 **17,87 €****11501570044**

EAN : 3221912229472  
**43 piezas: Puntas de atornillado LONG L25-50mm**

PH 1 -2 -3 / H3 -4 -5 -6 / Y1 -2 -3 / PZ 1 -2 -3 / PIN Hexa 2 -2,5 -3 -4 -5 -6 / Clutch 1 -2 -3 / TX 15 -20 -25 -30 -40 / Cuadrado 1 -2 -3 / Ranura 4,5 -5,5 -6,5 / TTX10 -15 -20 -25 -30 -40 / Spanner 4 -6 -8 -10 -12 | Estuche Ranger

Pcs : 43 **41,19 €****11521370009**

EAN : 3221912161253  
**Destornillador de precisión eléctrico**

Pcs : 15 **98,27 €****11501570045**

EAN : 3221912229489  
**103 piezas: Puntas de atornillado L25-50mm**

Puntas L50mm : PH1x7 PH2x7 PH3x7 / PZ1 x7 PZ2 x7 PZ3 x7 / TX20x7 TX25x7 TX30x6 + Puntas L25mm : PH1 x10 PH2x10 / PZ1 x10 PZ2 x10 | Estuche Ranger

Pcs : 103 **47,38 €****11521572010**

EAN : 3221912166166  
**46 piezas: Puntas mixtas | Hexa 6,35mm 4mm | TORSIÓN & PRECISIÓN**

Hexa 4mm: Pentalobe 0,8 -1,2 -1,5 / Ranura 1 -2 -2,5 / PH 000 -00 -0 -1 / PZ 000 -00 -0 -1 / TX T4 -5 -6 -8 / TA 2 -2,3 -2,7 / Triwing 0 Hexa 6,35mm: PH 1 -2 -2 -3 / PZ 1 -2 -2 -3 / TX Tx 15 -20 -25 -30 / Allen 3 -4 -5 -6 / Cuadrado 1 -2 -3

Pcs : 46 **34,47 €****11501572001**

EAN : 3221912107749  
**35 piezas: 34 puntas SECURITY SERIES + 1 PP magnético**

4 Torq / 5 doble punta / 4 Tri -wing / 6 Allen / 8 TX Tamper / 3 clutch / 4 triángulo + 1 portapuntas magnético

Pcs : 35 **19,98 €****11524270001**

EAN : 3221912006240  
**5 puntas INOX TORSIÓN PZ2**

PZ2 x5

Pcs : 5 **17,03 €****11501572002**

EAN : 3221912109040  
**22 piezas: 21 puntas ESTÁNDAR + 1 PP**

2 Ranura / 3 PZ / 3 PH / 6 TX / 4 Hexa / 3 cuadrado + 1 portapuntas magnético

Pcs : 22 **15,33 €****11524370001**

EAN : 3221912006264  
**5 puntas INOX TORSIÓN PH2**

PH2 x5

Pcs : 5 **17,03 €**



**11524570001**

EAN : 3221912006295  
**5 puntas INOX TORSIÓN TX20**

TX20 x5

Pcs : 5 **18,76 €****11521572005**

EAN : 3221912109064  
**22 piezas: 21 puntas TORSIÓN DIAMANTE + 1 PP magnético Quick Change**

4 ranura / 3 PZ / 3 PH / 7 TX / 4 Hexa + 1 portapuntas Quick Change magnético

Pcs : 22 **45,99 €****11521572001**

EAN : 3221912109057  
**22 piezas: 21 puntas TORSIÓN + 1 PP magnético**

4 ranura / 3 PZ / 3 PH / 7 TX / 4 Hexa + 1 portapuntas magnético

Pcs : 22 **21,04 €****11521572006**

EAN : 3221912107794  
**48 piezas: 47 puntas anillo TiN TORSIÓN + 1 PP magnético**

1 portapuntas magnético / PH 2X3 / PZ 2X3 | Maletín

Pcs : 48 **50,64 €****11521572002**

EAN : 3221912107763  
**35 piezas: 34 puntas TORSIÓN + 1 PP magnético**

4 ranura / 5 PZ / 5 PH / 8 TX / 8 TTX / 4 Hexa + 1 portapuntas magnético

Pcs : 35 **27,38 €****11521572007**

EAN : 3221912109088  
**22 piezas: 21 puntas TORSIÓN INOX + 1 PP magnético Quick Change**

5 PZ / 5 PH / 7 TX / 4 Hexa + 1 portapuntas Quick Change magnético

Pcs : 22 **45,36 €****11521572003**

EAN : 3221912107770  
**22 piezas: 21 puntas TiN TORSIÓN + 1 PP magnético Quick Change**

4 ranura / 3 PZ / 3 PH / 7 TX / 4 Hexa + 1 portapuntas Quick Change magnético

Pcs : 22 **26,32 €****11521572008**

EAN : 3221912109095  
**34 piezas: 19 puntas TORSIÓN + 7 vasos + 1 portavasos + 1 mango de trinquete**

4 PZ / 4 PH / 7 TX / 6 TTX / 4 Hexa / 7 llaves de vaso + 1 porta cojinetes 1/4" + 1 mango de atornillado 1/4"

Pcs : 34 **37,94 €****11521572004**

EAN : 3221912107787  
**35 piezas: 34 puntas TiN TORSIÓN + 1 PP magnético Quick Change**

4 ranura / 5 PZ / 5 PH / 8 TX / 8 TTX / 4 Hexa + 1 portapuntas Quick Change magnético

Pcs : 35 **36,90 €****11521572009**

EAN : 3221912111708  
**22 piezas: 21 puntas TORSIÓN IMPACT + 1 PP Quick Change**

5 PZ / 5 PH / 7 TX / 4 Hexa + 1 portapuntas Quick Change magnético | SHOCK SERIES

Pcs : 22 **31,61 €**

**11521572011**

EAN : 3221910927516  
**29 piezas: Puntas  
TORSIÓN IMPACT +  
Llaves de vaso de Ø6 a  
13mm 1 PP Impacto |  
SHOCK SERIES**

L25mm: PH1 -2 -2 -2 -3 / PZ1 -2 -2  
-3 / TX10 -20 -20 -25 -25 -30 -30 -40 +  
L50mm: PH2 -2 / PZ2 / TX20 -25 -30 +  
Llaves de vaso 6 -8 -10 -12 -13 + 1  
portapuntas de impacto

Pcs : 29

**38,66 €**

**11521320003**

EAN : 3221912230539  
**Portapuntas magnético  
 para tornillos largos**

Portapuntas modular de 60 a 70mm

Pcs : 1 **15,38 €**

**11501320013**

EAN : 3221910835460  
**Portapuntas Quick  
 Change L60mm**

Pcs : 1 **12,16 €**

**11501320001**

EAN : 3221910038878  
**Portapuntas magnético  
 L60mm**

Pcs : 1 **7,67 €**

**11501320005**

EAN : 3221910207847  
**Portapuntas SDS L75mm**

Pcs : 1 **10,87 €**

**11501320006**

EAN : 3221910556433  
**Portapuntas magnético  
 L100mm**

Pcs : 1 **11,05 €**

**11501320007**

EAN : 3221910556440  
**Adaptador para llave 1/4"**

Pcs : 1 **7,38 €**

**11501320002**

EAN : 3221910038885  
**Portapuntas para llave de  
 vaso 1/4"**

Pcs : 1 **5,69 €**

**11501320012**

EAN : 3221910836115  
**Guía de tornillo L120mm**

Pcs : 4 **14,79 €**

**11501320004**

EAN : 3221910900373  
**Portapuntas Quick  
 Change SDS L100mm**

Pcs : 1 **15,00 €**

**11501320016**

EAN : 3221910847845  
**Especial escayola L75mm  
 PH2**

Pcs : 1 **24,69 €**

**11501820002**

EAN : 3221910900366  
**Punta para escayola PH2**  
**L50mm | DRYWALL**  
**POWER BIT**

Pcs : 4 **8,99 €**

**11501320020**

EAN : 3221912272409  
**Portabrocas y**  
**portapuntas (2en1)**  
**L70-80mm**

1 portapuntas 2en1 para punta hexagonal 6,35mm y vaso cuadrado 1/4".

Pcs : 1 **12,90 €**

**11501320018**

EAN : 3221912142252  
**Portapuntas Quick**  
**Change orientable**  
**L93mm**

Pcs : 1 **22,84 €**

**11501320017**

EAN : 3221912050847  
**2 piezas: 1 portapuntas +**  
**1 extensión (blíster)**

1 mini destornillador / 1 extensión magnética para puntas de atornillado de precisión 4mm

Pcs : 2 **7,88 €**

**11501320003**

EAN : 3221910038892  
**3 adaptadores porta**  
**vasos**

Adaptador 1/4" + 1/2" + 3/8"

Pcs : 3 **10,06 €**

**11501320019**

EAN : 3221912146663  
**3 portapuntas SDS**  
**L65-72mm**

Pcs : 3 **12,05 €**

**11521320001**

EAN : 3221910899660  
**Portapuntas L50mm |**  
**IMPACT**

Pcs : 1 **25,41 €**

**11501330001**

EAN : 3221912111876  
**Portapuntas Quick**  
**Change L150mm**

Pcs : 1 **16,33 €**

**11501330002**

EAN : 3221912111883  
**Portapuntas Quick**  
**Change L300mm**

Pcs : 1 **21,04 €**

**11521320002**

EAN : 3221912142238  
**Portapuntas angular**  
**57Nm 200rpm (máx.)**

Pcs : 1 **62,76 €**



**11501320014**

EAN : 3221910836122  
**Portapuntas angular**  
**17Nm (máx.)**

Pcs : 1 **33,62 €**

**11501320009**

EAN : 3221910828134  
**Portapuntas flexible**  
**L180mm**

Pcs : 1 **16,26 €**

**11501320008**

EAN : 3221910556457  
**Portapuntas doble**  
**entrada**

Pcs : 1 **13,21 €**

**11110420001**

EAN : 3221912142245  
**Alfombrilla magnética**  
**para proyectos**

Alfombrilla magnética 25,4x20,32  
 escribible + Marcador borrable en seco  
 con tapón magnética / Toallita para  
 borrar

Pcs : 1 **15,61 €**

**11101830001**

EAN : 3221910881269  
**Imantador-desimantador**

1 bloc con 2 polos magnéticos

Pcs : 1 **12,63 €**

XT2106

**Cepillos violón | Mango madera |  
Revestimiento metálico o latonado**



XT21061 Envase unidades granel

CODE	EAN	Dim.	PCB	Qty	€ HT
XT20251006150	3128820061500	L190 acier rond	3	1	3,76
XT20251006349	3128820003494	L190 acier rond	12	1	3,04
XT20251006152	3128820061524	L190 acier plat	3	1	4,03
XT20251006153	3128820061531	L190 acier laitonné	3	1	4,03
XT20241306201	3128823062016	L300 acier laitonné	12	1	3,80

XT2100

**Cepillos con mango | Mango madera |  
Revestimiento metálico, inox o  
latonado**



XT21001 Envase unidades granel

CODE	EAN	Dim.	PCB	Qty	€ HT
XT20251006154	3128820061548	L300 acier rond	3	1	2,74
XT20241000375	3128820003753	L300 acier rond	12	1	2,33
XT20241500375	3128825003758	L300 acier rond	20	1	1,83
XT20251006155	3128820061555	L300 acier plat	3	1	2,74
XT20251006156	3128820061562	L300 acier ondulé	3	1	2,74
XT20251006157	3221912129093	L300 inox	3	1	5,19
XT20251006158	3128820061586	L300 Acier laitonné	3	1	4,23

XT2101

**Cepillo para bujías | Mango madera | Revestimiento latonado**



XT21011 Envase unidades granel

CODE	EAN	Dim.	PCB	Qty	€ HT
XT20251006161	3128820061616	L200 laiton rond	3	1	1,95
XT20241000376	3128820003760	L200 laiton rond	24	1	1,65
XT20241500376	3128825003765	L200 laiton rond	50	1	1,41
XT20241006162	3128820061623	L200 laiton ondulé	3	1	3,65

XT2102

**Cepillos ERGONÓMICOS | Convexos |  
Revestimiento acero, inox, latón o  
nallon**



XT21021 Envase unidades granel

CODE	EAN	Dim.	PCB	Qty	€ HT
XT20251006169	3128820061692	L235 acier	12	1	3,32
XT20251006170	3128820061708	L235 inox	12	1	4,30
XT20251006171	3128820061715	L235 Acier laitonné	12	1	4,70
XT20251006174	3221912006660	L370 Acier laitonné	3	1	5,04
XT20251006173	3221912006653	L235 nylon abrasif	3	1	5,56

XT2115

**Cepillo especial Joyería | Mango madera | Revestimiento metálico**



XT21151 Envase unidades granel

CODE	EAN	Dim.	PCB	Qty	€ HT
XT20251006166	3128820061661	L220 laiton	3	1	5,06

XT2116

**Cepillo pincel | Mango madera | Revestimiento metálico**



XT21161 Envase unidades granel

CODE	EAN	Dim.	PCB	Qty	€ HT
XT20251006168	3128820061685	200 acier rond	3	1	3,25

XT2120

**Carda de lima**



XT21201 Envase unidades granel

CODE	EAN	Dim.	PCB	Qty	€ HT
XT20251006163	3128820061630	Carde à lime	3	1	3,25

XT2122

**Cepillo con mango | Mango plástico |  
Revestimiento metálico**



XT21221 Envase unidades granel

CODE	EAN	Dim.	PCB	Qty	€ HT
XT20251006175	3221912129109	Acier rond	3	1	6,76

1T2103

**Cepillo pala**



1T21031 Envase unidades granel

CODE	EAN	Dim.	PCB	Qty	€ HT
XT20251006176	3221912259813	Brosse rabot	6	1	8,39

XT2067

**Cepillo circular escalonado TECHNIC | Hilo acero | Decapado del metal**



1T20682 Caja bl ster Box

CODE	EAN	Dim.	PCB	Qty	€ HT
XT202520131	3221912072344	75 /0,5	3	1	18,56



XT20672 Caja bl ster Box

CODE	EAN	Dim.	PCB	Qty	€ HT
XT202520140	3221912129024	60 /0,35	1	1	29,83



1T2048

**Cepillo circular TECHNIC | Hilo Inox | Decapado del Inox, metal**



XT2002

**Cepillo circular | Hilo acero trenzado | Gran decapado del metal**



XT20022 Blister

CODE	EAN	Dim.	PCB	Qty	€ HT
XT20252006068	3128820060688	75 /0,5	3	1	8,78



1T20482 Caja bl ster Box

CODE	EAN	Dim.	PCB	Qty	€ HT
XT202520125	3221912072313	70 /0,3	3	1	12,44



XT2004

**Cepillo circular | Hilo Inox | Decapado del Inox**



1T20032 Caja bl ster Box

CODE	EAN	Dim.	PCB	Qty	€ HT
XT202520122	3221912072283	70 /0,3	3	1	10,20



XT20042 Blister

CODE	EAN	Dim.	PCB	Qty	€ HT
XT20252006071	3128820060718	75 /0,35	3	1	10,42



XT2066

**Cepillo circular | Hilo acero ondulado | Decapado de metal**



XT2049

**Cepillo circular | Hilo acero latonado ondulado | Decapado de madera, lat n**



XT20492 Blister

CODE	EAN	Dim.	PCB	Qty	€ HT
XT20252006058	3128820060589	75x12 /0,35	3	1	9,55



XT20662 Blister

CODE	EAN	Dim.	PCB	Qty	€ HT
XT20252006050	3128820060503	38 /0,35	3	1	2,84
XT20252006052	3128820060527	50 /0,35	3	1	3,13
XT20252006054	3128820060541	75 /0,35	3	1	3,58
XT20252006056	3128820060565	100 /0,35	3	1	4,40



1T2049

**Cepillo circular | Hilo acero latonado ondulado | Decapado de madera, lat n**



XT2001

**Cepillo circular | Hilo acero ondulado | Decapado de metal**



1T20491 Envase unidades granel

CODE	EAN	Dim.	PCB	Qty	€ HT
XT20211000210	3221912259868	75	12	1	7,98

XT2065

**Cepillo circular | Hilo acero latonado | Decapado de madera**



XT20011 Blister

CODE	EAN	Dim.	PCB	Qty	€ HT
XT20211000201	3128820002015	38 /0,35	12	1	2,46
XT20211000202	3128820002022	50 /0,35	12	1	2,67
XT20211000203	3128820002039	75 /0,35	12	1	3,04
XT20211000204	3128820002046	100 /0,35	12	1	3,43



XT20652 Blister

CODE	EAN	Dim.	PCB	Qty	€ HT
XT20252006073	3128820060732	80x33 /0,25	3	1	8,93



1T2068

**Cepillo circular TECHNIC | Hilo acero trenzado | Gran decapado del metal**



XT2009

**Cepillo circular | Para taladro | Hilo acero ondulado | Decapado de madera**



XT20092 Blister

CODE	EAN	Dim.	PCB	Qty	€ HT
XT20252006051	3128820060510	50 /0,25	3	1	4,13
XT20252006053	3128820060534	75 /0,25	3	1	4,76
XT20252006055	3128820060558	100 /0,25	3	1	5,65



XT2040

Cepillo circular | Hilo nailon rojo | Decapado de madera



XT20402 Blister

CODE	EAN	Dim.	PCB	Qty	€ HT
XT20222000777	3128820007775	75 /	3	1	6,33
XT20222000778	3128820007782	100 /	3	1	6,76



1T2040

Cepillo circular | Hilo nailon rojo | Decapado de madera



1T20401 Envase unidades granel

CODE	EAN	Dim.	PCB	Qty	€ HT
XT20211000230	3221912259844	100	12	1	5,85

XT2041

Cepillo circular | Hilo nailon azul | Lijado de madera



XT20412 Blister

CODE	EAN	Dim.	PCB	Qty	€ HT
XT20222000783	3128820007836	75 /	3	1	6,33
XT20222000784	3128820007843	100 /	3	1	6,76



1T2028

Cepillo copa TECHNIC | Hilo inox | Mango hexa | Decapado del inox, metal



1T20282 Blister

CODE	EAN	Dim.	PCB	Qty	€ HT
XT202520124	3221912072306	75 /0,3	3	1	14,96



XT2064

Cepillo copa | Hilo inox | Decapado del inox



XT20642 Blister

CODE	EAN	Dim.	PCB	Qty	€ HT
XT20252006072	3128820060725	75 /0,35	3	1	8,20



XT2051

Cepillo copa | Hilo acero ondulado | Decapado de metal



XT20512 Blister

CODE	EAN	Dim.	PCB	Qty	€ HT
XT20252006060	3128820060602	50 /0,35	3	1	2,88
XT20252006062	3128820060626	75 /0,35	3	1	3,70



XT2008

Cepillo copa | Hilo acero ondulado | Decapado de metal (lote)



XT20081 Envase unidades granel

CODE	EAN	Dim.	PCB	Qty	€ HT
XT20211000205	3128820002053	50 /0,35	12	1	1,91
XT20211000206	3128820002060	75 /0,35	12	1	3,43



1T2069

Cepillo copa TECHNIC | Hilo acero trenzado | Gran decapado del metal



1T20692 Caja blíster Box

CODE	EAN	Dim.	PCB	Qty	€ HT
XT202520130	3221912072337	75 /0,5	3	1	21,14



XT2010

Cepillo copa | Hilo acero trenzado | Gran decapado del metal



XT20102 Blister

CODE	EAN	Dim.	PCB	Qty	€ HT
XT20252006049	3128820060497	75 /0,5	3	1	9,61



1T2052

Cepillo copa TECHNIC | Hilo acero latonado | Decapado de madera, latón, cobre



1T20522 Caja blíster Box

CODE	EAN	Dim.	PCB	Qty	€ HT
XT202520121	3221912072276	75	3	1	13,95



XT2053

**Cepillo copa | Hilo acero latonado | Decapado de todos los materiales**



XT20532 Blister

CODE	EAN	Dim.	PCB	Qty	€ HT
XT20252006057	3128820060572	75 /0,35	3	1	7,18



**1T2053**

**Cepillo copa | Hilo acero latonado | Decapado de todos los materiales**



1T20531 Envase unidades granel

CODE	EAN	Dim.	PCB	Qty	€ HT
XT20211000215	3221912259851	75	12	1	6,05

**XT2016**

**Cepillo copa | Hilo acero ondulado | Decapado de madera**



XT20162 Blister

CODE	EAN	Dim.	PCB	Qty	€ HT
XT20252006059	3128820060596	50 /0,25	3	1	2,71
XT20252006061	3128820060619	75 /0,25	3	1	3,55



**XT2042**

**Cepillo copa | Hilo nailon rojo | Decapado de madera**



XT20422 Blister

CODE	EAN	Dim.	PCB	Qty	€ HT
XT20222000779	3128820007799	45 /	3	1	6,86
XT20222000780	3128820007805	65 /	3	1	7,69



**1T2042**

**Cepillo copa | Hilo nailon rojo | Decapado de madera**



1T20421 Envase unidades granel

CODE	EAN	Dim.	PCB	Qty	€ HT
XT20211000235	3221912259837	65	12	1	6,46

**XT2043**

**Cepillo copa | Hilo nailon azul | Lijado de madera**



XT20432 Blister



CODE	EAN	Dim.	PCB	Qty	€ HT
XT20222000786	3128820007867	65 /	3	1	7,69

**1T2070**

**Cepillo pincel TECHNIC | Hilo inox | Decapado del inox, metal**



1T20702 Blister

CODE	EAN	Dim.	PCB	Qty	€ HT
XT202520123	3221912072290	24 /0,3	3	1	10,76



**1T2054**

**Cepillo pincel TECHNIC | Hilo acero ondulado | Gran decapado del metal**



1T20542 Blister

CODE	EAN	Dim.	PCB	Qty	€ HT
XT202520129	3221912072320	24 /0,5	3	1	14,94



**XT2055**

**Cepillo pincel | Hilo acero ondulado | Decapado de metal**



XT20552 Blister

CODE	EAN	Dim.	PCB	Qty	€ HT
XT20252006063	3128820060633	18 /0,35	3	1	3,87
XT20252006064	3128820060640	22 /0,35	3	1	3,98
XT20252006065	3128820060657	28 /0,35	3	1	4,56



**XT2012**

**Cepillo pincel | Hilo acero ondulado | Decapado de metal**



XT20122 Envase unidades granel

CODE	EAN	Dim.	PCB	Qty	€ HT
XT20212000270	3128820002701	28 /0,35	12	1	3,92

**1T2056**

**Cepillo pincel TECHNIC | Hilo acero latonado | Decapado de madera, latón, cobre**



1T20562 Blister

CODE	EAN	Dim.	PCB	Qty	€ HT
XT202520120	3221912072269	24 /0,3	3	1	9,26



**XT2044**

**Cepillo pincel | Hilo nailon rojo | Decapado de madera**





XT20442 Blister

CODE	EAN	Dim.	PCB	Qty	€ HT
XT20222000781	3128820007812	22	3	1	5,91



XT2045

**Cepillo pincel | Hilo nallon azul | Lijado de madera**



XT20452 Blister

CODE	EAN	Dim.	PCB	Qty	€ HT
XT20222000787	3128820007874	22	3	1	5,91



XT2046

**Cepillo abanico | Hilo nallon rojo | Decapado de madera (funda cartón)**



XT20462 Blister

CODE	EAN	Dim.	PCB	Qty	€ HT
XT20222000782	3128820007829	100	3	1	10,97



XT20461 Envase unidades granel

CODE	EAN	Dim.	PCB	Qty	€ HT
XT20221500782	3128825007824	100	30	1	9,55



1T2046

**Cepillo abanico | Hilo nallon rojo | Decapado de madera**



1T20461 Envase unidades granel

CODE	EAN	Dim.	PCB	Qty	€ HT
XT20211000240	3221912259820	100	12	1	9,41

XT2015

**Cepillo abanico | Hilo acero ondulado | Decapado de metal**



XT20152 Blister

CODE	EAN	Dim.	PCB	Qty	€ HT
XT20252006066	3128820060664	50 / 0,35	3	1	4,92
XT20252006067	3128820060671	75 / 0,35	3	1	5,47



1T2071

**Cepillo cilíndrico TECHNIC | Hilo Inox | Decapado de metal**

1T20712 Blister

CODE	EAN	Dim.	PCB	Qty	€ HT
XT202520136	3221912072382	28 / 0,3	3	1	14,19

XT2035

**Cepillo cilíndrico | Hilo acero ondulado | Decapado de metal**

XT20352 Blister

CODE	EAN	Dim.	PCB	Qty	€ HT
XT20252006075	3221910899356	28 / 0,35	1	1	4,12
XT20252006076	3221910899363	20 / 0,35	1	1	4,57
XT20252006077	3221910899370	38 / 0,35	1	1	4,73



1T2057

**Cepillo cilíndrico | Hilo nallon | Decapado de metal**

1T20572 Blister

CODE	EAN	Dim.	PCB	Qty	€ HT
XT20252006080	3221912129017	28	1	1	4,57



XT2017

**Cepillo copa | Feltro | Pulido de madera barnizada y metal**



XT20172 Blister

CODE	EAN	Dim.	PCB	Qty	€ HT
XT20252000227	3221912085160	75	3	1	13,74



XT2058

**Cepillo circular | Feltro | Pulido de madera barnizada y metal**



XT20582 Blister

CODE	EAN	Dim.	PCB	Qty	€ HT
XT20252000229	3221912085177	100	3	1	13,30



XT2059

**Cepillo para lustrar**



XT20592 Blister

CODE	EAN	Dim.	PCB	Qty	€ HT
XT20252000226	3128820002268	80	3	1	10,48



XT2036

**Tambor de pulido**



XT20362 Blister

CODE	EAN	Dim.	PCB	Qty	€ HT
XT20252006079	3221910899394	125	1	1	10,61





**1T2031**

**Cepillo copa TECHNIC | Hilo acero ondulado | Decapado de metal**



└─ **1T20312** Caja blister Box

CODE	EAN	Dim.	PCB	Qty	€ HT
XT202520134	3221912072368	80	1	1	16,00



**1T2061**

**Cepillo cónico TECHNIC | Hilo acero trenzado | Gran decapado del metal**



└─ **1T20612** Blister

CODE	EAN	Dim.	PCB	Qty	€ HT
XT202520137	3221912128959	95 /0,5	1	1	19,40



**XT2031**

**Cepillo copa | Hilo acero ondulado | Decapado de metal (funda cartón)**



└─ **XT20312** Blister

CODE	EAN	Dim.	PCB	Qty	€ HT
XT20252006000	3128820060008	75 /0,35	1	1	7,56
XT20252006001	3128820060015	100 /0,35	1	1	11,60



**1T2062**

**Cepillo copa TECHNIC | Hilo acero latonado | Decapado de madera, latón, cobre**



└─ **1T20622** Caja blister Box

CODE	EAN	Dim.	PCB	Qty	€ HT
XT202520135	3221912072375	80 /0,3	1	1	15,49



└─ **XT20311** Envase unidades granel

CODE	EAN	Dim.	PCB	Qty	€ HT
XT20211000369	3128820003692	75 /0,35	6	1	6,57

**XT2032**

**Cepillo copa | Hilo latón | Decapado de latón, madera**



└─ **XT20322** Blister

CODE	EAN	Dim.	PCB	Qty	€ HT
XT20252006007	3128820060077	70 /0,25	1	1	12,01



**1T2033**

**Cepillo cónico TECHNIC | Hilo acero ondulado | Decapado del metal**



└─ **1T20332** Blister

CODE	EAN	Dim.	PCB	Qty	€ HT
XT202520138	3221912128966	100 /0,35	1	1	17,91



**XT2030**

**Cepillo circular | Hilo acero trenzado | Decapado de metal**



└─ **XT20302** Blister

CODE	EAN	Dim.	PCB	Qty	€ HT
XT20252006005	3128820060053	95 /0,5	1	1	14,05



**1T2060**

**Cepillo copa TECHNIC | Hilo acero trenzado | Gran decapado del metal**



└─ **1T20602** Caja blister Box

CODE	EAN	Dim.	PCB	Qty	€ HT
XT202520133	3221912072351	75 /0,5	1	1	17,63



**1T2032**

**Cepillo nallon M14 | Especial puldora | Pulido de madera**



└─ **1T20321** Envase unidades granel

CODE	EAN	Dim.	PCB	Qty	€ HT
XT20211000371	3221912259912	130	1	1	47,80

**XT2034**

**Cepillo copa | Hilo acero trenzado | Gran decapado del metal (funda cartón)**



└─ **XT20342** Blister

CODE	EAN	Dim.	PCB	Qty	€ HT
XT20252006002	3128820060022	65 /0,35	1	1	11,70
XT20252006003	3128820060039	90 /0,5	1	1	22,03



└─ **XT20341** Envase unidades granel

CODE	EAN	Dim.	PCB	Qty	€ HT
XT20211000370	3128820003708	65 /0,35	6	1	10,42



**XT2039**

**Cepillo de amoladora | Hilo acero  
ondulado | Decapado de metal**



└ **XT20394** Funda cartón

CODE	EAN	Dim.	PCB	Qty	€ HT
<b>XT20254006100</b>	3128820061005	125x20 /0,35	1	1	12,52
<b>XT20254006102</b>	3128820061029	150x15 /0,35	1	1	15,78
<b>XT20254006104</b>	3128820061043	200x15 /0,35	1	1	21,13



**XT20252000566**

EAN : 3128820005665  
**3 mini cepillos | Pincel/  
 Copa/Plano | Para taladro**  
 Ø5mm -10mm -28mm

Pcs : 3 **10,48 €**

**XT20252580206**

EAN : 3221912259806  
**3 cepillos para metal |  
 Ø24-50-75mm | Para  
 taladro**

Cepillo pincel Ø24mm + Cepillo copa  
 Ø50mm + Cepillo circular Ø75mm

Pcs : 3 **8,64 €**

**XT20252580200**

EAN : 3128825802009  
**5 cepillos + 2 muelas  
 "cepillado&pulido" | Para  
 taladro**

Cepillos circulares Ø50 -75mm /  
 Cepillo copa Ø50mm / Cepillo pincel /  
 Muelas ojivas -cónicas / Cepillo de  
 mano

Pcs : 7 **13,39 €**

**XT20252580207**

EAN : 3221912259790  
**3 cepillos nailon |  
 Ø24-65-75mm | Para  
 taladro**

Cepillo copa Ø75 / Cepillo circular  
 Ø75 / Cepillo pincel Ø22

Pcs : 3 **15,76 €**

**XT20252580201**

EAN : 3221912006523  
**3 cepillos mango  
 hexagonal para metal + 1  
 adaptador SDS+ | Para  
 taladro**

Cepillo circular Ø75mm / Cepillo copa  
 Ø75mm / Cepillo pincel Ø22mm /  
 Portapuntas SDS+ Quick Change

Pcs : 4 **14,35 €**

**XT20252580208**

EAN : 3221912259783  
**3 cepillos para metal |  
 Ø100mm | Para  
 amoladora**

Cepillo copa Ø100mm / Cepillo cónico  
 Ø100mm / Cepillo giratorio Ø100mm

Pcs : 3 **28,98 €**

**XT20252580202**

EAN : 3221912006530  
**3 cepillos mango  
 hexagonal para madera +  
 1 adaptador SDS+ | Para  
 taladro**

Cepillo circular Ø75mm / Cepillo copa  
 Ø75mm / Cepillo pincel Ø22mm /  
 Portapuntas SDS+ Quick Change

Pcs : 4 **15,54 €**

**XT20252580205**

EAN : 3221912085184  
**3 cepillos a mano |  
 Mango de plástico**

3 cepillos de mano: hilo de acero  
 ondulado, hilo de latón corrugado, hilo  
 de nailon

Pcs : 3 **10,01 €**



XT1131

**Hojas abrasivas CORINDÓN |**  
**230x280mm (funda cartón)**



CODE	EAN	Dim.	PCB	Qty	€ HT
XT10131013040	3128820130404	Gr50	6	3	2,25
XT10131013041	3128820130411	Gr80	6	3	2,25
XT10131013042	3128820130428	Gr120	6	3	2,25
XT10131013043	3128820130435	Gr150	6	3	2,25

XT11311 Envase granel

CODE	EAN	Dim.	PCB	Qty	€ HT
XT10131013001	3128820130015	Gr40	6	3	1,92
XT10131013002	3128820130022	Gr80	6	3	1,92
XT10131013003	3128820130039	Gr120	6	3	1,92
XT10131013004	3128820130046	Gr180	6	3	1,92
XT10131013005	3128820130053	Gr40/80/120	6	3	1,92

XT11314 Envase granel

CODE	EAN	Dim.	PCB	Qty	€ HT
XT10134013100	3128820131005	Gr40	50	1	0,52
XT10134013101	3128820131012	Gr80	50	1	0,52
XT10134013102	3128820131029	Gr120	50	1	0,52
XT10134013103	3128820131036	Gr180	50	1	0,52

XT1132

**Hojas abrasivas papel de lija (Sillex) |**  
**230x280mm (funda cartón)**



XT11321 Envase granel

CODE	EAN	Dim.	PCB	Qty	€ HT
XT10131013010	3128820130107	Gr50	6	5	1,54
XT10131013011	3128820130114	Gr80	6	5	1,54
XT10131013012	3128820130121	Gr120	6	5	1,54
XT10131013013	3128820130138	Gr150	6	5	1,54
XT10131000605	3128820006051	Gr50/80/120	25	24	4,54

XT11324 Envase granel

CODE	EAN	Dim.	PCB	Qty	€ HT
XT10134013110	3128820131104	Gr50	50	1	0,22
XT10134013111	3128820131111	Gr80	50	1	0,22
XT10134013112	3128820131128	Gr120	50	1	0,22
XT10134013113	3128820131135	Gr150	50	1	0,22

XT1133

**Hojas abrasivas anti-embotamiento |**  
**230x280mm (funda cartón)**



XT11331 Envase granel

CODE	EAN	Dim.	PCB	Qty	€ HT
XT10131013020	3128820130206	Gr120	6	3	2,18
XT10131013021	3128820130213	Gr180	6	3	2,18
XT10131013022	3128820130220	Gr240	6	3	2,18
XT10131013023	3128820130237	Gr320	6	3	2,18

XT11334 Envase granel

CODE	EAN	Dim.	PCB	Qty	€ HT
XT10134013120	3128820131203	Gr120	50	1	0,55
XT10134013121	3128820131210	Gr180	50	1	0,55
XT10134013122	3128820131227	Gr240	50	1	0,55
XT10134013123	3128820131234	Gr320	50	1	0,55

XT1134

**Hojas abrasivas tela esmeril |**  
**230x280mm (funda cartón)**



XT11341 Envase granel

XT11344 Envase granel

CODE	EAN	Dim.	PCB	Qty	€ HT
XT10134013140	3128820131401	Gr50	50	1	0,61
XT10134013141	3128820131418	Gr80	50	1	0,61
XT10134013142	3128820131425	Gr120	50	1	0,61
XT10134013143	3128820131432	Gr150	50	1	0,61

XT1135

**Hojas abrasivas impermeables |**  
**230x280mm (granel)**



XT11351 Envase granel

CODE	EAN	Dim.	PCB	Qty	€ HT
XT10131013030	3128820130305	Gr180	6	3	2,19
XT10131013031	3128820130312	Gr240	6	3	2,19
XT10131013032	3128820130329	Gr400	6	3	2,19
XT10131013033	3128820130336	Gr600	6	3	2,19

XT11354 Envase granel

CODE	EAN	Dim.	PCB	Qty	€ HT
XT10134013130	3128820131302	Gr180	50	1	0,55
XT10134013131	3128820131319	Gr240	50	1	0,55
XT10134013132	3128820131326	Gr400	50	1	0,55
XT10134013133	3128820131333	Gr600	50	1	0,55
XT10134013134	3221912220714	Gr 800	50	3	0,83
XT10134013135	3221912220721	Gr 1200	50	3	0,83

XT1153

**Esponja con revestimiento abrasivo**  
**70x100mm (funda cartón)**



XT11532 Blister

CODE	EAN	Dim.	PCB	Qty	€ HT
XT10152015070	3128820150709	Fine	3	1	3,55
XT10152015071	3128820150716	Medium	3	1	3,55

XT1136

**Rollo abrasivo CORINDÓN |**  
**115mmx5m**



XT11361 Envase granel

CODE	EAN	Dim.	PCB	Qty	€ HT
XT10131500611	3128825006117	Gr40	10	1	3,80
XT10131500612	3128825006124	Gr80	10	1	3,80
XT10131500613	3128825006131	Gr120	10	1	3,80

**XT1103**

**Patín malla | Auto-adherente | 93x190mm | Vibratoria (funda cartón)**



CODE	EAN	Dim.	PCB Qty	€ HT
XT10122019100	3221910896256	Gr40	3	8   7,98
XT10122019101	3221910896263	Gr80	3	8   7,98
XT10122019102	3221910896270	Gr120	3	8   7,98
XT10122019103	3221910896287	Gr180	3	8   7,98
XT10122019104	3221910896294	Gr2x40 2x80 1x120	3	8   7,98

**XT11032** Funda cartón

CODE	EAN	Dim.	PCB Qty	€ HT
XT10122019070	3221910896089	Gr40	3	5   6,91
XT10122019071	3221910896096	Gr80	3	5   6,91
XT10122019072	3221910896102	Gr120	3	5   6,91
XT10122019073	3221910896119	Gr180	3	5   6,91
XT10122019074	3221910896126	Gr2x40 2x80 1x120	3	5   6,91



**XT11031** Funda cartón

CODE	EAN	Dim.	PCB Qty	€ HT
XT10121018704	3221910898793	Gr2x40 2x80 1x120	6	5   5,79



**XT1104**

**Patín malla | 93x230mm | Para lijadora vibratoria**



**XT11042** Funda cartón

CODE	EAN	Dim.	PCB Qty	€ HT
XT10122019080	3221910896133	Gr40	3	8   6,01
XT10122019081	3221910896140	Gr80	3	8   6,01
XT10122019082	3221910896157	Gr120	3	8   6,01
XT10122019083	3221910896164	Gr180	3	8   6,01
XT10122019084	3221910896171	Gr2x40 2x80 1x120	3	8   6,01



**XT1105**

**Patín malla especial escayola | 93x230mm | Para lijadora vibratoria**



**XT11052** Funda cartón

CODE	EAN	Dim.	PCB Qty	€ HT
XT10122019085	3221910896188	Gr150	3	4   5,86
XT10122019086	3221910896195	Gr220	3	4   5,86



**XT1106**

**Patín malla | Auto-adherente | 115x230mm | Para lijadora vibratoria**



**XT11062** Funda cartón

CODE	EAN	Dim.	PCB Qty	€ HT
XT10122019090	3221910896201	Gr40	3	5   11,47
XT10122019091	3221910896218	Gr80	3	5   11,47
XT10122019092	3221910896225	Gr120	3	5   11,47
XT10122019093	3221910896232	Gr180	3	5   11,47
XT10122019094	3221910896249	Gr2x40 2x80 1x120	3	5   11,47



**XT1107**

**Patín malla | 115x280mm | Para lijadora vibratoria**



**XT11072** Funda cartón



**XT1108**

**Patín malla especial escayola | 115x280mm | Para lijadora vibratoria**



**XT11082** Funda cartón

CODE	EAN	Dim.	PCB Qty	€ HT
XT10122019105	3221910896300	Gr150	3	4   7,03
XT10122019106	3221910896317	Gr220	3	4   7,03



**XT1101**

**Patín malla | Auto-adherente | Ø125mm | Para lijadora excéntrica (funda cartón)**



**XT11012** Funda cartón

CODE	EAN	Dim.	PCB Qty	€ HT
XT10112019120	3221910895716	Gr40	3	4   6,10
XT10112019121	3221910895723	Gr80	3	4   6,10
XT10112019122	3221910895730	Gr120	3	4   6,10
XT10112019123	3221910895747	Gr180	3	4   6,10
XT10112019124	3221910895754	Gr1x40 2x80 1x120	3	4   6,10



**XT1102**

**Patín malla | Auto-adherente | Ø150mm | Para lijadora excéntrica**



**XT11022** Funda cartón

CODE	EAN	Dim.	PCB Qty	€ HT
XT10112019110	3221910895679	Gr40	3	4   9,06
XT10112019111	3221910895686	Gr80	3	4   9,06
XT10112019112	3221910895693	Gr120	3	4   9,06
XT10112019113	3221910895709	Gr180	3	4   9,06



**XT1123**

**Patín malla auto-adherente | Ø180mm | Para lijadora excéntrica**



**XT11231** Funda cartón

CODE	EAN	Dim.	PCB Qty	€ HT
XT10111018720	3221912019431	Gr80	8	5   11,30
XT10111018721	3221912019448	Gr180	8	5   11,30



**XT1124**

**Patín malla auto-adherente | Ø225mm | Para lijadora excéntrica**



**XT11241** Funda cartón

CODE	EAN	Dim.	PCB Qty	€ HT
XT10111018730	3221912019455	Gr80	8	5   14,27



CODE	EAN	Dim.	PCB	Qty	€ HT
XT10111018731	3221912019462	Gr180	8	5	14,27

**XT1116**

**Patín malla | Auto-adherente | 95x95x95mm | Delta (funda cartón)**



**XT11162** Funda cartón

CODE	EAN	Dim.	PCB	Qty	€ HT
XT10122019010	3221910895839	Gr40	3	4	4,75
XT10122019011	3221910895846	Gr80	3	4	4,75
XT10122019012	3221910895853	Gr120	3	4	4,75
XT10122019013	3221910895860	Gr180	3	4	4,75
XT10122019014	3221910895877	Gr1x40 2x80 1x120	3	4	4,75



**XT1115**

**Patín malla | Auto-adherente | 105x105x105mm | Para lijadora Delta**



**XT11152** Funda cartón

CODE	EAN	Dim.	PCB	Qty	€ HT
XT10122019000	3221910895785	Gr40	3	4	5,38
XT10122019001	3221910895792	Gr80	3	4	4,85
XT10122019002	3221910895808	Gr120	3	4	4,85
XT10122019003	3221910895815	Gr180	3	4	4,85
XT10122019004	3221910895822	Gr1x40 2x80 1x120	3	4	5,09



**XT1111**

**Patín malla | Auto-adherente | 175x105mm | Para lijadora multi B&D**



**XT11112** Funda cartón

CODE	EAN	Dim.	PCB	Qty	€ HT
XT10122019030	3221910895938	Gr40	3	4	8,08
XT10122019031	3221910895945	Gr80	3	4	8,08
XT10122019032	3221910895952	Gr120	3	4	8,08
XT10122019033	3221910895969	Gr180	3	4	8,08



**XT1113**

**Patín malla | Auto-adherente | 135x95mm | Para lijadora mouse B&D**



**XT11132** Funda cartón

CODE	EAN	Dim.	PCB	Qty	€ HT
XT10122019060	3221910896041	Gr40	3	4	5,88
XT10122019061	3221910896058	Gr80	3	4	5,88
XT10122019062	3221910896065	Gr120	3	4	5,88
XT10122019063	3221910896072	Gr180	3	4	5,88



**XT1112**

**Patín malla | Auto-adherente | 140x98mm | Para lijadora Mac Allister**



**XT11122** Funda cartón

CODE	EAN	Dim.	PCB	Qty	€ HT
XT10121018012	3128820180133	Gr80	6	12	3,62
XT10121018011	3128820180126	Gr120	6	12	3,59



CODE	EAN	Dim.	PCB	Qty	€ HT
XT10122019050	3221910896003	Gr40	3	4	6,72
XT10122019051	3221910896010	Gr80	3	4	5,94
XT10122019052	3221910896027	Gr120	3	4	5,94
XT10122019053	3221910896034	Gr180	3	4	5,94

**XT1110**

**Patín malla | Auto-adherente | 152x102mm | Multi (funda cartón)**



**XT11102** Funda cartón

CODE	EAN	Dim.	PCB	Qty	€ HT
XT10122019020	3221910895884	Gr40	3	4	5,88
XT10122019021	3221910895891	Gr80	3	4	5,88
XT10122019022	3221910895907	Gr120	3	4	5,88
XT10122019023	3221910895914	Gr180	3	4	5,88
XT10122019024	3221910895921	Gr1x40 2x80 1x120	3	4	5,88



**XT1009**

**Patín auto-adherente | 93x190mm | Para lijadora vibratoria**



**XT10092** Funda cartón

CODE	EAN	Dim.	PCB	Qty	€ HT
XT10122012005	3128820120054	Gr40	6	6	4,90
XT10122012006	3128820120061	Gr80	6	6	4,90
XT10122012007	3128820120078	Gr120	6	6	4,90
XT10122012008	3221910897314	Gr180	6	6	4,90



**XT1005**

**Patín no perforado | 93x230mm | Para lijadora vibratoria (funda cartón)**



**XT10052** Funda cartón

CODE	EAN	Dim.	PCB	Qty	€ HT
XT10122012100	3128820121006	Gr40	3	10	4,88
XT10122012101	3128820121013	Gr80	3	10	4,54
XT10122012102	3128820121020	Gr120	3	10	4,54
XT10122012103	3128820121037	Gr180	3	10	4,54



**XT10051** Funda cartón

CODE	EAN	Dim.	PCB	Qty	€ HT
XT10121000088	3128820000882	Gr6x40 6x80 6x120	3	18	4,54



**XT1006**

**Patín perforado | 93x230mm | Para lijadora vibrante (funda cartón)**



**XT10062** Funda cartón

CODE	EAN	Dim.	PCB	Qty	€ HT
XT10122012130	3128820121303	Gr40	3	10	5,81
XT10122012131	3128820121310	Gr80	3	10	5,30
XT10122012132	3128820121327	Gr120	3	10	5,30
XT10122012133	3128820121334	Gr180	3	10	5,27



**XT10061** Funda cartón

CODE	EAN	Dim.	PCB	Qty	€ HT
XT10121018012	3128820180133	Gr80	6	12	3,62
XT10121018011	3128820180126	Gr120	6	12	3,59



**XT1010**

**Patín auto-adherente | 115x230mm | Para lijadora vibratoria**



CODE	EAN	Dim.	PCB	Qty	€ HT
XT10111018214	3128820182144	Gr40	6	5	3,87
XT10111018213	3128820182137	Gr80	6	5	3,87
XT10111018212	3128820182120	Gr120	6	5	3,87
XT101131000607	3128820006075	Gr6x40 6x80 6x120	3	18	10,76

**XT10102** Funda cartón

CODE	EAN	Dim.	PCB	Qty	€ HT
XT10122012250	3221910897321	Gr40	3	6	8,82
XT10122012251	3221910897338	Gr80	3	6	8,82
XT10122012252	3221910897345	Gr120	3	6	8,82
XT10122012253	3221910897352	Gr180	3	6	8,82



**XT1007**

**Patín no perforado | 115x280mm | Para lijadora vibratoria**



**XT10072** Funda cartón

CODE	EAN	Dim.	PCB	Qty	€ HT
XT10122012200	3128820122003	Gr40	3	10	7,07
XT10122012201	3128820122010	Gr80	3	10	6,18
XT10122012202	3128820122027	Gr120	3	10	5,62
XT10122012203	3128820122034	Gr180	3	10	5,62



**XT1008**

**Patín perforado | 93x230mm | Para lijadora vibrante**



**XT10082** Funda cartón

CODE	EAN	Dim.	PCB	Qty	€ HT
XT10122012240	3128820122409	Gr40	3	10	8,57
XT10122012241	3128820122416	Gr80	3	10	7,52
XT10122012242	3128820122423	Gr120	3	10	7,42
XT10122012243	3128820122430	Gr180	3	10	7,18



**XT1002**

**Disco auto-adherente | Ø115mm | Perforación 8 agujeros**



**XT10022** Funda cartón

CODE	EAN	Dim.	PCB	Qty	€ HT
XT10112011200	3128820112004	Gr40	3	6	4,93
XT10112011201	3128820112011	Gr80	3	6	4,93
XT10112011202	3128820112028	Gr120	3	6	4,93
XT10112011203	3128820112035	Gr180	3	6	4,93



**XT1003**

**Disco auto-adherente | Ø125mm | Perforación 8 agujeros (funda cartón)**

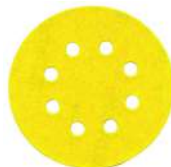

**XT10032** Funda cartón

CODE	EAN	Dim.	PCB	Qty	€ HT
XT10112011210	3128820112103	Gr40	3	6	5,73
XT10112011211	3128820112110	Gr80	3	6	5,73
XT10112011212	3128820112127	Gr120	3	6	5,73
XT10112011213	3128820112134	Gr180	3	6	5,73



**XT10031** Funda cartón

**XT1208**

**Disco auto-adherente | Ø125mm**



**XT12082** Funda cartón

CODE	EAN	Dim.	PCB	Qty	€ HT
XT10112011110	3128820111106	Gr40	3	6	6,81
XT10112011111	3128820111113	Gr80	3	6	6,64
XT10112011112	3128820111120	Gr120	3	6	6,50



**XT1001**

**Disco abrasivo | Ø127mm | Para taladro**



**XT10012** Funda cartón

CODE	EAN	Dim.	PCB	Qty	€ HT
XT10112011001	3128820110017	Gr40	3	10	5,31
XT10112011002	3128820110024	Gr80	3	10	4,63
XT10112011003	3128820110031	Gr120	3	10	4,63
XT10112011004	3128820110048	Gr2x40 3x80 3x120	3	8	5,76



**XT1004**

**Disco auto-adherente | Ø150mm | Perforación 6 agujeros**



**XT10042** Funda cartón

CODE	EAN	Dim.	PCB	Qty	€ HT
XT10112011220	3128820112202	Gr40	3	6	7,83
XT10112011221	3128820112219	Gr80	3	6	7,83
XT10112011222	3128820112226	Gr120	3	6	7,83
XT10112011223	3128820112233	Gr180	3	6	7,83



**XT1020**

**Patín auto-adherente | 95x95x95mm | Para lijadora delta | Lote de 5**



**XT10202** Funda cartón

CODE	EAN	Dim.	PCB	Qty	€ HT
XT10122012040	3128820120405	Gr40	3	5	3,65
XT10122012041	3128820120412	Gr80	3	5	3,65
XT10122012042	3128820120429	Gr120	3	5	3,65
XT10122012043	3128820120436	Gr180	3	5	3,65



**XT10207** Funda cartón

CODE	EAN	Dim.	PCB	Qty	€ HT
XT10122000158	3128820001582	Gr6x40 6x80 6x120	3	18	7,05



**XT1018**

**Disco auto-adherente | 175x105mm | Multi B&D (funda cartón)**





**XT10182** Funda cartón

CODE	EAN	Dim.	PCB	Qty	€ HT
XT10122012020	3128820120207	Gr40	3	5	6,75
XT10122012021	3128820120214	Gr80	3	5	6,75
XT10122012022	3128820120221	Gr120	3	5	6,75
XT10122012023	3128820120238	Gr180	3	5	6,75



**XT10181** Funda cartón

CODE	EAN	Dim.	PCB	Qty	€ HT
XT10111000213	3128820002138	Gr6x40 6x80 6x120	3	18	11,92



**XT1019**

**Disco auto-adherente | 135x95mm | Para lijadora mouse multi B&D**



**XT10192** Funda cartón

CODE	EAN	Dim.	PCB	Qty	€ HT
XT10122022240	3221910897918	Gr40	6	6	4,86
XT10122022241	3221910897925	Gr80	6	6	4,86
XT10122022242	3221910897932	Gr120	6	6	4,86
XT10122022243	3221910897949	Gr180	6	6	4,86



**XT1017**

**Disco auto-adherente | 152x102mm | Para lijadora multi**



**XT10172** Funda cartón

CODE	EAN	Dim.	PCB	Qty	€ HT
XT10122022250	3221910897956	Gr40	6	6	4,86
XT10122022251	3221910897963	Gr80	6	6	4,86
XT10122022252	3221910897970	Gr120	6	6	4,86
XT10122022253	3221910897987	Gr180	6	6	4,86



**XT1141**

**Banda lima | 13x454mm | Para lima eléctrica (funda cartón)**



**XT11412** Funda cartón

CODE	EAN	Dim.	PCB	Qty	€ HT
XT10142014001	3128820140014	Gr50	3	4	6,55
XT10142014002	3128820140021	Gr80	3	4	6,55
XT10142014003	3128820140038	Gr120	3	4	6,55
XT10142014004	3128820140045	Gr2x50 1x80 1x120	3	4	6,55



**XT11411** Funda cartón

CODE	EAN	Dim.	PCB	Qty	€ HT
XT10141000178	3128820001780	50/80/120	3	12	9,76



**XT1144**

**Banda continua | 75x457mm | Para lijadora de banda continua**



**XT11442** Funda cartón

CODE	EAN	Dim.	PCB	Qty	€ HT
XT10142014201	3128820142018	Gr50	1	2	6,17



CODE	EAN	Dim.	PCB	Qty	€ HT
XT10142014202	3128820142025	Gr80	1	2	6,17
XT10142014203	3128820142032	Gr120	1	2	6,17

**XT1145**

**Banda continua | 75x533mm | Para lijadora de banda continua**



**XT11452** Funda cartón

CODE	EAN	Dim.	PCB	Qty	€ HT
XT10142014221	3128820142216	Gr50	1	2	6,85
XT10142014222	3128820142223	Gr80	1	2	6,85
XT10142014223	3128820142230	Gr120	1	2	6,85



**XT1146**

**Banda continua | 100x560mm | Para lijadora de banda continua**



**XT11462** Funda cartón

CODE	EAN	Dim.	PCB	Qty	€ HT
XT10142014311	3128820143114	Gr50	1	2	7,74
XT10142014312	3128820143121	Gr80	1	2	7,74
XT10142014313	3128820143138	Gr120	1	2	7,74



**XT1147**

**Banda continua | 100x610mm | Para lijadora de banda continua**



**XT11472** Funda cartón

CODE	EAN	Dim.	PCB	Qty	€ HT
XT10142014321	3128820143213	Gr50	1	2	8,06
XT10142014322	3128820143220	Gr80	1	2	8,06
XT10142014323	3128820143237	Gr120	1	2	8,06





**XT1037**

**Disco de carburo de Tungsteno**



XT10372 Blister

CODE	EAN	Dim.	PCB	Qty	€ HT
XT10112011310	3128820113100	Ø115 Gr10	3	1	28,38
XT10112011311	3128820113117	Ø115 Gr16	3	1	24,35



**XT1026**

**Disco láminas zirconio**



XT10262 Blister

CODE	EAN	Dim.	PCB	Qty	€ HT
XT10112011340	3128820113407	Ø115 Gr36	3	1	7,56
XT10112011341	3128820113414	Ø115 Gr60	3	1	7,51
XT10112011342	3128820113421	Ø115 Gr80	3	1	7,46



**1T1041**

**Disco fibra cerámica | Especial acero inoxidable**



1T10412 Blister

CODE	EAN	Dim.	PCB	Qty	€ HT
XT10112011335	3221912129031	Ø125 Gr36	3	2	11,06
XT10112011336	3221912129048	Ø125 Gr60	3	2	10,05
XT10112011337	3221912129055	Ø125 Gr80	3	2	9,95



**XT1027**

**Disco láminas zirconio**



XT10272 Blister

CODE	EAN	Dim.	PCB	Qty	€ HT
XT10112011343	3128820113438	Ø125 Gr36	3	1	7,96
XT10112011344	3128820113445	Ø125 Gr60	3	1	7,78
XT10112011345	3128820113452	Ø125 Gr80	3	1	7,71



**XT1023**

**Disco fibra zirconio**



XT10232 Blister

CODE	EAN	Dim.	PCB	Qty	€ HT
XT10112011320	3128820113209	Ø115 Gr24	3	2	4,85
XT10112011321	3128820113216	Ø115 Gr50	3	2	4,85
XT10112011322	3128820113223	Ø115 Gr80	3	2	4,85



**XT1028**

**Disco láminas COMBINADO**



XT10282 Blister

CODE	EAN	Dim.	PCB	Qty	€ HT
XT10112011350	3128820113506	Ø115 Gr80	3	1	19,85



**XT1024**

**Disco fibra zirconio**



XT10242 Blister

CODE	EAN	Dim.	PCB	Qty	€ HT
XT10112011325	3128820113254	Ø125 Gr24	3	2	5,43
XT10112011326	3128820113261	Ø125 Gr50	3	2	5,43
XT10112011327	3128820113278	Ø125 Gr80	3	2	5,43

**XT1029**

**Disco láminas COMBINADO**



XT10292 Blister

CODE	EAN	Dim.	PCB	Qty	€ HT
XT10112011360	3128820113605	Ø125 Gr80	3	1	21,87
XT10112011390	3128820113902	Ø125 Gr120	3	1	21,87



**XT1025**

**Disco fibra zirconio**



XT10252 Blister

CODE	EAN	Dim.	PCB	Qty	€ HT
XT10112011330	3128820113308	Ø180 Gr24	3	2	8,46
XT10112011331	3128820113315	Ø180 Gr50	3	2	8,46
XT10112011332	3128820113322	Ø180 Gr80	3	2	8,46

**1T1042**

**Disco en láminas | Cerámica y zirconio**



1T10422 Blister

CODE	EAN	Dim.	PCB	Qty	€ HT
XT10112011346	3221912129062	Ø125 Gr40	3	1	9,09
XT10112011347	3221912129079	Ø125 Gr60	3	1	9,00
XT10112011348	3221912129086	Ø125 Gr80	3	1	8,96



**XT1030**

**Disco láminas DOBLES SOBREDIMENSIONADAS | Zirconio**



XT10302 Blister

CODE	EAN	Dim.	PCB	Qty	€ HT
XT10112011405	3128820114053	Ø115 Gr40	3	1	7,49



**XT1036**

**Disco láminas DOBLES SOBREDIMENSIONADAS | Zirconio**

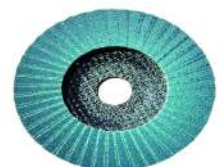

▬ **XT10362** Blister

CODE	EAN	Dim.	PCB	Qty	€ HT
XT10112011425	3128820114251	Ø125 Gr40	3	1	8,62



**XT1038**

**Disco láminas corindón**



▬ **XT10381** Blister

CODE	EAN	Dim.	PCB	Qty	€ HT
XT10111511115	3128825111156	Ø115 Gr50	40	1	4,05

**XT1039**

**Disco láminas corindón**



▬ **XT10391** Blister

CODE	EAN	Dim.	PCB	Qty	€ HT
XT10111511125	3128825111255	Ø125 Gr50	40	1	4,72

**XT1031**

**Disco semi rígido | Para amoladora**



▬ **XT10312** Blister

CODE	EAN	Dim.	PCB	Qty	€ HT
XT10112011300	3128820113001	Ø115 Gr36	3	1	6,78
XT10112011301	3128820113018	Ø115 Gr80	3	1	6,78



**XT1032**

**Disco semi rígido | Para amoladora**



▬ **XT10322** Blister

CODE	EAN	Dim.	PCB	Qty	€ HT
XT10112011302	3128820113025	Ø125 Gr36	3	1	7,20
XT10112011303	3128820113032	Ø125 Gr80	3	1	7,20



**XT1033**

**Disco semi rígido | Para amoladora**



▬ **XT10332** Blister

CODE	EAN	Dim.	PCB	Qty	€ HT
XT10112011304	3128820113049	Ø180 Gr36	3	1	9,43
XT10112011305	3128820113056	Ø180 Gr80	3	1	9,43



XT1171

**Rueda nailon comprimida | Ø75mm | Mango 6mm**



XT11712 Blister

CODE	EAN	Dim.	PCB	Qty	€ HT
XT10152015029	3128820150297	Ø40 Gr60	3	1	6,23
XT10152015030	3128820150303	Ø60 Gr60	3	1	6,98
XT10152015032	3128820150327	Ø60 Gr60	3	1	7,83
XT10152015033	3128820150334	Ø60 Gr120	3	1	7,83

XT1174

**Rueda de láminas abrasivas | Mango 6mm**



XT11742 Blister

CODE	EAN	Dim.	PCB	Qty	€ HT
XT10152015034	3128820150341	Ø60 Gr80	3	1	9,26
XT10152015035	3128820150358	Ø60 Gr180	3	1	9,26
XT10152015036	3128820150365	Ø30 Gr60	3	1	7,88
XT10152015037	3128820150372	Ø40 Gr60	3	1	8,17

XT1180

**Disco mousse abrasivo | Para taladro | Mango 6mm**



XT11802 Blister

CODE	EAN	Dim.	PCB	Qty	€ HT
XT10152015038	3128820150389	Ø100 Gr80	3	1	15,09
XT10152015039	3128820150396	Ø60 Gr80	3	1	10,18

XT11801 Blister

CODE	EAN	Dim.	PCB	Qty	€ HT
XT10151515038	3128825150384	Ø100 Gr80	10	1	12,51

XT1181

**Disco mousse abrasivo | Para taladro | Mango 6mm**



XT11812 Blister

CODE	EAN	Dim.	PCB	Qty	€ HT
XT10152015041	3128820150419	Ø127 Gr80	3	1	10,90
XT10152015043	3128820150433	Ø127 Gr80	3	1	17,14

XT1178

**Disco mousse abrasivo | Para taladro | Mango 6mm**



XT11782 Blister

CODE	EAN	Dim.	PCB	Qty	€ HT
XT10152015040	3128820150402	Ø100 Gr40	3	1	10,43
XT10152015042	3128820150426	Ø100 Gr40	3	1	16,39

XT1118

**Disco carburo de Tungsteno | Ø125mm**



XT11182 Funda cartón

CODE	EAN	Dim.	PCB	Qty	€ HT
XT10112011035	3128820110352	Gr40	3	1	8,20
XT10112011036	3128820110369	Gr80	3	1	8,65

XT6026

**Muela abrasiva | Circular | Ø80**



XT60262 Blister

CODE	EAN	Dim.	PCB	Qty	€ HT
XT60662000299	3128820002992	Ø80	3	1	4,61

XT6027

**Muela abrasiva | Cilíndrica | Ø20**

XT60272

CODE	EAN	Dim.	PCB	Qty	€ HT
XT60662000504	3128820005047	Ø20	3	1	3,40

XT6029

**Muela abrasiva | Ojiva | Ø20**

XT60292

CODE	EAN	Dim.	PCB	Qty	€ HT
XT60662000508	3128820005085	Ø20	3	1	3,40

XT6028

**Muela abrasiva | Platlillo | Ø40**



XT60282

CODE	EAN	Dim.	PCB	Qty	€ HT
XT60662000524	3128820005245	Ø40	3	1	4,86

XT6031

**Muela abrasiva | Cónica | Ø14>32**

XT60312

CODE	EAN	Dim.	PCB	Qty	€ HT
XT60662000526	3128820005269	Ø14 > 32	3	1	4,86

XT6032

**Muela de afilar Ø60**



**XT60322**

CODE	EAN	Dim.	PCB	Qty	€ HT
XT60662000554	3128820005542	Ø60	3	1	8,18



**XT6052**

**Surtido de muelas Ø20mm**



**XT60522** Blister

CODE	EAN	Dim.	PCB	Qty	€ HT
XT60662000536	3128820005368	Ø20	3	3	8,47



**XT6033**

**Surtido muelas Ø8>10mm**



**XT60332**

CODE	EAN	Dim.	PCB	Qty	€ HT
XT60662000557	3128820005573	Ø8 > 10	3	3	7,89



**XT1194**

**Disco de pulido auto-adherente**



XT11942 Blister

CODE	EAN	Dim.	PCB	Qty	€ HT
XT10152015056	3221912197160	Ø180	1	1	13,93
XT10152015052	3128820150525	Ø125	3	1	11,57



**XT1193**

**Bolna de pulido con cordones**



XT11932 Blister

CODE	EAN	Dim.	PCB	Qty	€ HT
XT10152015055	3221912197153	Ø180	1	1	12,29
XT10152015050	3128820150501	Ø125	3	1	8,42



**XT2037**

**Disco de pulido | Auto-adherente**



XT20372 Blister

CODE	EAN	Dim.	PCB	Qty	€ HT
XT20252006078	3221910899387	125	1	1	8,86



**XT1210**

**Plato pulido | Excéntrico**



XT12102

CODE	EAN	Dim.	PCB	Qty	€ HT
XT10162016041	3221912006721	Ø150	1	1	34,51

**XT10152015012**  
 EAN : 3221912006707  
**Mango abrasivo velco 195mm**

Pcs : 5 **13,91 €**



**XT10152015011**  
 EAN : 3221912006691  
**Taco de pulido flexible Ø125mm**

Pcs : 1 **11,58 €**



**XT10152015010**  
 EAN : 3128820150105  
**Taco de pulido rígido Ø125x70mm**

Pcs : 1 **6,71 €**



**XT10151515015**  
 EAN : 3128825150155  
**Taco de pulido flexible auto-adherente Ø125x70mm**  
 1 taco de pulido velcro + 12 hojas corin GR40 -80 -120

Pcs : 13 **9,63 €**



**XT10151515035**  
 EAN : 3128825150353  
**Patin abrasivo auto-adherente | Para taco de pulido Ø125x70mm**

Pcs : 21 **9,77 €**



**XT101510001**  
 EAN : 3221912259875  
**Piedra para afilar 230x35x14mm | Mixto G120/G240**

Pcs : 1 **4,50 €**



**XT10111018615**

EAN : 3128820186159  
**Taco de pulido rígido**  
**Ø230x115mm + 2 patines**  
 Taco 115x230mm + 2 patines GR120

Pcs : 3 **12,17 €**

**XT60692000253**

EAN : 3128820002534  
**Porta herramientas**  
**Ø12,7mm**

Pcs : 1 **4,05 €**

**XT10151515011**

EAN : 3128825150117  
**Taco de pulido rígido**  
**85x160mm | Almohadilla**  
**anti-incrustante**  
 Taco 85x160mm + 3 patines GR120

Pcs : 4 **11,83 €**

**XT10152015049**

EAN : 3128820150495  
**Pasta para abrillantar u**  
**pulir | Acabado**

Pcs : 2 **7,96 €**

**XT10152015045**

EAN : 3128820150457  
**Disco fieltro para pulir**  
**Ø100mm**

Pcs : 1 **9,80 €**

**XT10152015057**

EAN : 3221912224576  
**Espanja de pulido**  
**autoadherente**  
**Ø180x35mm**

Pcs : 1 **11,46 €**

**XT10152015046**

EAN : 3128820150464  
**Disco algodón para pulir**  
**Ø100mm**

Pcs : 1 **9,80 €**

**XT10162016020**

EAN : 3128820160203  
**Plato pulido STABIFLEX**  
**Ø125mm velcro | Mano &**  
**Taladro | Mango de**  
**Ø8mm con 2 planos**

Pcs : 1 **24,75 €**

**XT60692000510**

EAN : 3128820005108  
**Porta herramientas**  
**Ø10mm**

Pcs : 1 **3,40 €**

**XT10112011009**

EAN : 3128820110093  
**Plato pulido Ø125mm**  
 Ø125mm | con marco y almohadilla  
 abrasiva

Pcs : 10 **13,90 €**

**XT10162016001**

EAN : 3128820160012  
**Plato pulidor taladro**  
 Ø125mm

Pcs : 1 **6,68 €**

**XT10162016016**

EAN : 3128820160166  
**Plato pulido autoadherete**  
 de caucho | Escariado  
 M14 | Mango de Ø125mm

Pcs : 1 **14,67 €**

**XT10162016004**

EAN : 3128820160043  
**Plato pulido autoadherete**  
 de caucho | Mango de  
 8mm Ø125mm

Pcs : 1 **13,63 €**

**XT10162016021**

EAN : 3221912070661  
**Plato pulido autoadherete**  
 | Mixto: escariado M14 |  
 Mango de 6mm Ø115mm

Pcs : 1 **9,56 €**

**XT10162016010**

EAN : 3128820160104  
**Plato pulido de caucho** |  
 Escariado M14 | Mango  
 de Ø115mm

Pcs : 1 **12,45 €**

**XT10162016022**

EAN : 3221912100528  
**Plato pulido autoadherete**  
 | Mixto: escariado M14 |  
 Mango de 6mm Ø125mm

Pcs : 1 **12,55 €**

**XT10162016011**

EAN : 3128820160111  
**Plato pulido de caucho** |  
 Escariado M14 | Mango  
 de Ø125mm

Pcs : 1 **13,76 €**

**XT10162016012**

EAN : 3128820160128  
**Plato pulido de caucho** |  
 Escariado M14 | Mango  
 de Ø180mm

Pcs : 1 **21,07 €**

120019

**TECHNIC | Sierra de corona Diamante en seco | Mango Hexagonal**



└─ **1200192** Caja blister Box

CODE	EAN	Dim.	PCB	Qty	€ HT
12000922000	3221912110299	20	1	1	34,43
12000922500	3221912110305	25	1	1	38,14
12000923500	3221912110329	35	1	1	44,93
12000924400	3221912110336	44	1	1	56,27
12000926500	3221912110343	65	1	1	84,14
12000926800	3221912110350	68	1	1	87,93



120005

**Sierra corona Diamante | Mango cilíndrico (blister)**



└─ **1200052** Caja blister Box

CODE	EAN	Dim.	PCB	Qty	€ HT
12000523500	3128824510356	35	1	1	26,85
12000524400	3128824510448	44	1	1	29,68
12000525300	3128824510530	53	1	1	33,32
12000526500	3128824510653	65	1	1	39,11
12000526800	3128824510684	68	1	1	39,11
12000528300	3128824510837	83	1	1	48,02
120005210000	3128824511001	100	1	1	58,08
120005211000	3128824511100	110	1	1	61,86





**12000570002**

EAN : 3128824520003

**6 sierras corona DIAMANTE de Ø35 a 83mm**

Ø35 -44 -53 -65 -67 -83mm | Maletín

Pcs : 6

**125,22 €**

**XT5217**

**Sierra corona multi carburo | 1 hoja**



**1T52282** Caja blíster Box

CODE	EAN	Dim.	PCB	Qty	€ HT
XT505220100	3221912281739	19	1	1	14,50
XT505220101	3221912281746	22	1	1	14,50
XT505220102	3221912281753	25	1	1	15,30
XT505220103	3221912281760	27	1	1	15,30
XT505220104	3221912281777	32	1	1	16,15
XT505220105	3221912281784	35	1	1	17,20
XT505220106	3221912281791	40	1	1	17,45
XT505220107	3221912281807	44	1	1	20,45
XT505220108	3221912281814	48	1	1	20,45
XT505220109	3221912281821	51	1	1	20,45
XT505220110	3221912281838	60	1	1	24,55
XT505220111	3221912281845	65	1	1	24,55
XT505220112	3221912281852	68	1	1	24,55
XT505220113	3221912281869	73	1	1	25,75
XT505220114	3221912281876	76	1	1	25,75
XT505220115	3221912281883	83	1	1	26,90
XT505220116	3221912281890	102	1	1	37,40
XT505220117	3221912281906	127	1	1	62,10
XT505220118	3221912281913	152	1	1	85,90

**XT52172** Caja blíster Box

CODE	EAN	Dim.	PCB	Qty	€ HT
XT505220010	3221912164445	35	1	1	10,84
XT505220011	3221912164438	40	1	1	11,82
XT505220012	3221912164421	45	1	1	14,97
XT505220013	3221912164414	50	1	1	16,72
XT505220014	3221912164407	60	1	1	21,21
XT505220015	3221912164391	68	1	1	26,22
XT505220016	3221912164384	80	1	1	28,85
XT505220017	3221912164377	85	1	1	29,88
XT505220025	3221912288073	105	1	1	31,55
XT505220026	3221912288080	112	1	1	35,85
XT505220027	3221912288097	127	1	1	39,30
XT505220028	3221912288103	152	1	1	47,40

**XT5199**

**Sierra corona HCS HEXA | 1 hoja**



**XT5203**

**Sierra corona BI-METAL | 1 hoja**



**XT51992** Caja blíster Box

CODE	EAN	Dim.	PCB	Qty	€ HT
XT505220001	3221912164483	40	1	1	7,23
XT50522052004	3128820520045	65	1	1	7,83
XT50522000675	3128820006754	65	3	1	7,05
XT50522052006	3128820520069	68	1	1	7,83
XT505220002	3221912164469	80	3	1	10,17

**XT5201**

**Sierra corona HCS | Multihojas**



**XT52032** Caja blíster Box

CODE	EAN	Dim.	PCB	Qty	€ HT
XT50522052200	3128820522001	19	1	1	7,28
XT50522052204	3128820522049	22	1	1	8,11
XT50522052206	3128820522063	25	1	1	8,73
XT50522052210	3128820522100	29	1	1	9,57
XT50522052214	3128820522148	32	1	1	10,42
XT50522052216	3128820522162	35	1	1	10,69
XT50522052220	3128820522209	40	1	1	11,30
XT50522052222	3128820522223	44	1	1	11,87
XT50522052224	3128820522247	51	1	1	12,13
XT505220030	3221912164339	53	1	1	12,44
XT50522052228	3128820522285	60	1	1	13,73
XT50522052230	3128820522308	65	1	1	15,17
XT50522052232	3128820522322	68	1	1	15,90
XT505220031	3221912164308	71	1	1	16,88
XT50522052234	3128820522346	73	1	1	17,29
XT50522052236	3128820522360	76	1	1	18,43
XT505220032	3221912164292	80	1	1	19,02
XT50522052238	3128820522384	83	1	1	19,12
XT505220033	3221912164254	86	1	1	21,11
XT50522052244	3128820522445	102	1	1	24,57
XT505220034	3221912164247	110	1	1	26,37
XT505220035	3221912164230	127	1	1	29,83

**XT52012** Caja blíster Box

CODE	EAN	Dim.	PCB	Qty	€ HT
XT50522052012	3128820520120	25-32-38-45-50-56-62 (±18mm)	1	7	6,86
XT50522052010	3128820520106	25-32-38-45-50-56-62 (±22,5mm)	1	7	9,75
XT50522052014	3128820520144	28-35-50-68-75 (±30mm)	3	5	19,49
XT50522052000	3128820520007	60-67-74 (±32mm)	1	3	14,72
XT50522052002	3128820520021	60-67-74-81-95 (±32mm)	1	5	22,28
XT50522185220	3128821852206	26-32-38-45-50-56-63 (±18mm)	1	7	4,20
XT50522068100	3221912163936	68-74-80-90-100 (±38mm)	1	5	25,65

**XT5219**

**Sierra rotativa ajustable | Mango hexa | 30>120**



**XT5204**

**Sierra corona BI-METAL | Monobloc**



**XT52192** Caja blíster Box

CODE	EAN	Dim.	PCB	Qty	€ HT
XT50522030120	3221912163974	30>120	1	1	17,53

**1T5228**

**Sierra corona bimetálica Cobalto 8% | 1 hoja | Uso Intensivo**



**XT52212** Caja blíster Box

CODE	EAN	Dim.	PCB	Qty	€ HT
XT505220060	3221912164087	35 SDS	1	1	19,05
XT50522052229	3128820522292	65 SDS	1	1	22,05
XT50522052233	3128820522339	67 SDS	1	1	22,76



**XT5221**

**Sierra corona BI-METAL SDS+ | 1 hoja**



1T5204

**Corona HSS + Pilot + Expulsor**



CODE	EAN	Dim.	PCB	Qty	€ HT
XT505220074	3221912164032	73	1	1	22,96
XT505220075	3221912164025	83	1	1	24,52
XT505220076	3221912164018	103	1	1	27,66

1T52044 Tubo colgable

CODE	EAN	Dim.	PCB	Qty	€ HT
XT505240001	3221912219657	16	1	1	10,98
XT505240002	3221912219688	18	1	1	12,36
XT505240003	3221912219695	20	1	1	13,73
XT505240004	3221912219701	22	1	1	15,05
XT505240005	3221912219718	24	1	1	16,42
XT505240006	3221912219725	25	1	1	17,14
XT505240007	3221912219732	26	1	1	17,80
XT505240008	3221912219749	27	1	1	18,51
XT505240009	3221912219756	30	1	1	20,54
XT505240010	3221912219763	32	1	1	21,87
XT505240011	3221912219770	35	1	1	23,95



XT5208

**Sierra corona HM metal duro | Multi-hojas**



XT52082 Caja blíster Box

CODE	EAN	Dim.	PCB	Qty	€ HT
XT50522052424	3128820524241	33-53-73-83 mm	1	4	34,00



XT5112

**Sierra corona metal duro HM | 1 hoja+base | Uso corriente**



XT51122 Caja blíster Box

CODE	EAN	Dim.	PCB	Qty	€ HT
XT50522500674	3128825006742	67	10	1	18,49
XT50522052416	3128820524166	103	1	1	25,15

XT5207

**Sierra corona HM metal duro | 1 hoja**



XT52072 Caja blíster Box

CODE	EAN	Dim.	PCB	Qty	€ HT
XT50522052400	3128820524005	33	1	1	6,02
XT50522052402	3128820524029	43	1	1	6,62
XT50522052404	3128820524043	53	1	1	6,48
XT50522052408	3128820524081	67	1	1	7,64
XT50522052412	3128820524128	73	1	1	8,73
XT50522052414	3128820524142	83	1	1	10,21



XT5226

**Sierra corona HM metal duro monobloc**



XT52262 Caja blíster Box

CODE	EAN	Dim.	PCB	Qty	€ HT
XT505220070	3221912164070	33	1	1	14,25
XT505220071	3221912164063	43	1	1	15,79
XT505220072	3221912164056	53	1	1	17,34
XT505220073	3221912164049	67	1	1	19,72



**XT50522052420**  
 EAN : 3128820524203  
**Husillo guía mango hexagonal L137mm**  
 L137mm Ø33-83mm

Pcs : 1 **10,21 €**



**XT50527052016**  
 EAN : 3128820520168  
**11 piezas: 8 sierras de corona HCS Ø22 a 68mm + 2 ejes + Llave**  
 Ø22 -25 -29 -35 -38 -44 -51 -68mm + 2 husillos con mango hexagonal + Llave Allen | Maletín

Pcs : 11 **15,05 €**



**XT50527052700**  
 EAN : 3128820527006  
**9 piezas: 6 sierras de corona BI-METAL de Ø22 a 68mm + 1 eje + Adaptador**  
 Ø22 -29 -35 -44 -51 -68mm + 2 husillos con mango hexagonal + 1 adaptador | Maletín

Pcs : 8 **59,49 €**



**XT50527052900**  
 EAN : 3128820529000  
**5 piezas: 4 sierras de corona BI-METAL de Ø67 a 102mm + 1 eje piloto de mango hexagonal**  
 Ø67 -73 -80 -102mm + 1 husillo con mango hexagonal | Maletín

Pcs : 7 **74,99 €**



**XT50527052800**

EAN : 3128820528003  
**7 piezas: 5 sierras de corona CARBURO HM de Ø33 a 83mm + 1 eje + Base**

Ø33 -53 -67 -73 -83mm +1 husillo con mango hexagonal + 1 base | Maletín

Pcs : 6

**45,14 €**

**XT50527052950**

EAN : 3128820529505  
**20 piezas: kit de sierra de corona EXTENSIBLE de Ø40 a 200mm**

Corona Ø280mm / 1 guía extensible Ø40>200 mm / 2 hojas HCS / 2 hojas metal duro / 2 brocas centradoras / 5 brocas madera / 5 brocas hormigón / Llave Allen | Maletín

Pcs : 20

**71,84 €**

**XT5211**

**Kit corona carburo | Mango SDS+**



└ **XT52112** Caja blister Box

CODE	EAN	Dim.	PCB	Qty	€ HT
XT505220085	3221912163998	35	1	1	25,34
XT50522052606	3128820526061	40	1	1	29,73
XT50522052602	3128820526023	65	1	1	25,75
XT50522052608	3128820526085	68	1	1	31,94
XT50522052610	3128820526108	80	1	1	34,61



**109075**

**Corona pesada CK**



└ **1090754** Caja blister Box

CODE	EAN	Dim.	PCB	Qty	€ HT
10907543000	3221910863951	30	1	1	70,31
10907543500	3221910863968	35	1	1	71,62
10907544000	3221910863975	40	1	1	72,96
10907544500	3221910863982	45	1	1	75,48
10907545000	3221910863999	50	1	1	84,17
10907546000	3221910864002	60	1	1	89,91
10907546600	3221910864729	66	1	1	93,51
10907547000	3221910864026	70	1	1	110,66
10907548000	3221910864033	80	1	1	116,34
10907549000	3221910864040	90	1	1	124,98
109075410000	3221910863920	100	1	1	143,70
109075411000	3221910863937	110	1	1	158,72
109075412500	3221910863944	125	1	1	195,46



**XT5206**

**Perforador/Cortador de grifos**



└ **XT52062** Blister

CODE	EAN	Dim.	PCB	Qty	€ HT
XT50522052302	3128820523022	32	1	1	23,50
XT50522052304	3128820523046	35	1	1	23,76



**XT50522052450**

EAN : 3128820524500  
**Sierra rotativa de carburo  
 ajustable de Ø30 a 80mm**

Sierra rotativa extensible Ø20>80mm

Pcs : 1 **18,80 €**



**Husillo guía BIM | Mango HEXA**

XT52052 Blister

CODE	EAN	Dim.	PCB	Qty	€ HT
XT50522052248	3128820522483	14>30	1	1	9,50
XT50522052250	3128820522506	32>152	1	1	16,12



**Husillo guía BIM | Mango SDS+**

XT52232 Blister

CODE	EAN	Dim.	PCB	Qty	€ HT
XT50522052256	3128820522568	14>30	1	1	14,63
XT50522052258	3128820522582	32>152	1	1	17,35



**Husillo guía HM**

XT52092

CODE	EAN	Dim.	PCB	Qty	€ HT
XT505220080	3221912164001		1	1	10,22
XT50522052418	3128820524180		1	1	5,45



**Portabrocas CK | Mango SDSmax**

1090764 Tubo colgable

CODE	EAN	Dim.	PCB	Qty	€ HT
10907640001	3221910864057	200	1	1	80,08
10907640002	3221910864064	450	1	1	86,63



**Anillos de reducción | Sierra circular**

XT50052 Blister

CODE	EAN	Dim.	PCB	Qty	€ HT
XT50512004235	3128820042356	30	1	1	3,04
XT50512004240	3128820042400	30	1	1	3,04
XT50512004265	3128820042653	30	1	1	3,04
XT50512004255	3128820042554	25	1	1	3,04
XT50512004260	3128820042608	20	1	1	3,04



**XT505220021**  
 EAN : 3221912164360  
**Husillo guía MULTI CARBURO | Ø35>85mm**

Pcs : 1 **17,81 €**



**XT50522052246**

EAN : 3128820522469  
**Broca guía HM | Ø6mm x L75mm**

Pcs : 1 **5,31 €**



**10907441100**

EAN : 3221910863913  
**Broca guía corona Ø11mm CK**

Pcs : 1 **14,84 €**



**10907840001**

EAN : 3221910864118  
**Cuña extractora CK**

Pcs : 1 **14,96 €**



**12001620650**

EAN : 3221912166296  
**Centrador de broca carburo Ø6,5mm | DIAMANTE AL AGUA**

Pcs : 1 **5,28 €**



**1110092452010**

EAN : 3128824520102  
**Guía taladrado DIAMANTE**

Pcs : 1 **39,99 €**



**1T5033 MADERA MELAMINA | Hoja de sierra de calar | TECHNIC**

1T50332 Blister

CODE	EAN	Dim.	PCB	Qty	€ HT
XT505526003	3221912082848	Mixte / Finition	1	2	10,34



**1T5023 MADERA DE MELAMINA | Hoja de sierra de calar | TECHNIC**

1T50232 Blister

CODE	EAN	Dim.	PCB	Qty	€ HT
XT505526004	3221912082855	Droite / Finition	1	2	9,55



**1T5034 MADERA DURA MASIVA | Hoja de sierra de calar | TECHNIC**

1T50342 Blister

CODE	EAN	Dim.	PCB	Qty	€ HT
XT505526005	3221912082862	Mixte / Finition	1	2	10,34



**1T5022 MADERA DURA MASIVA | Hoja de sierra de calar | TECHNIC**

1T50222 Blister

CODE	EAN	Dim.	PCB	Qty	€ HT
XT505526006	3221912082879	Droite / Finition	1	2	9,55



**1T5029 MATERIALES ESPECÍFICOS | Hoja de sierra de calar | TECHNIC**

1T50292 Blister

CODE	EAN	Dim.	PCB	Qty	€ HT
XT505526010	3221912082916	Droite / Finition	1	2	9,14
XT505520004	3221910898472	Droite / Finition	6	2	7,20



**1T5020 MADERA BLANDA Y AGLOMERADO | Hoja de sierra de calar**

1T50202 Blister

CODE	EAN	Dim.	PCB	Qty	€ HT
XT505520001	3221910898441	Courbe / Rapide	6	2	5,13
XT505520002	3221910898458	Droite / Rapide	6	2	5,13
XT505520003	3221910898465	Courbe / Finition	6	2	5,13
XT505520006	3221910898496	Droite / Finition	1	2	5,13
XT505520007	3221910898502	Droite / Rapide	1	2	5,13
XT505520019	3221910899172	Droite / Finition	1	2	5,13



**1T5021 ESTANTERÍAS | Hoja de sierra de calar**

1T50212 Blister

CODE	EAN	Dim.	PCB	Qty	€ HT
XT505520005	3221910898489	Droite / Finition	6	2	7,20



**1T5035 CARPINTERÍA MADERA | Hoja de sierra de calar**

1T50352 Blister



CODE	EAN	Dim.	PCB	Qty	€ HT
XT505520008	3221910898519	Droite / Finition	3	2	9,30

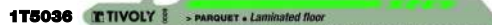

**1T5036 PARQUET | Hoja de sierra de calar**

1T50362 Blister

CODE	EAN	Dim.	PCB	Qty	€ HT
XT505520009	3221910898526	Droite / Finition	1	2	9,30
XT505520010	3221910898533	/ Finition	3	2	9,30

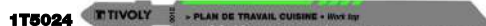

**1T5024 PLAN DE TRABAJO | Hoja de sierra de calar**

1T50242 Blister

CODE	EAN	Dim.	PCB	Qty	€ HT
XT505520012	3221910898557	Droite / Finition	3	2	9,30



**1T5027 PLACAS DE YESO | Hoja de sierra de calar**

1T50272 Blister

CODE	EAN	Dim.	PCB	Qty	€ HT
XT505520016	3221910898595	Droite / Rapide	3	1	13,47



**1T5030 EMBALDOSADO | Hoja de sierra de calar**

1T50302 Blister

CODE	EAN	Dim.	PCB	Qty	€ HT
XT505520018	3221910898618	Droite / Finition	3	1	9,30



**1T5031 MULTI-MATERIALES | Hoja sierra de calar**

1T50312 Blister

CODE	EAN	Dim.	PCB	Qty	€ HT
XT505520011	3221910898540	Droite / Finition	3	2	10,26



**1T5025 CHAPA METAL | Hoja de sierra de calar**

1T50252 Blister

CODE	EAN	Dim.	PCB	Qty	€ HT
XT505520013	3221910898564	Droite / Finition	1	2	7,20
XT505520014	3221910898571	Droite / Finition	6	2	7,20
XT505520020	3221912252241	Courbe / Finition	1	2	7,20



**1T5026 ALUMINIO | Hoja de sierra de calar**

1T50262 Blister

CODE	EAN	Dim.	PCB	Qty	€ HT
XT505520015	3221910898588	Droite / Finition	6	2	7,20



**1T5028 INOX | Hoja sierra de calar**

1T50282 Blister





CODE EAN Dim. PCB Qty € HT  
 XT505520017 | 3221910898601 | Droite / Finition | 3 | 2 | 9,30



**MADERA MELAMINA | Hoja de sierra de calar | TECHNIC**

1T50382 Blister

CODE EAN Dim. PCB Qty € HT  
 XT505326003 | 3221912082725 | Mixte / Finition | 1 | 2 | 10,34



**MADERA MELAMINA | Hoja de sierra de calar | TECHNIC**

1T50432 Blister

CODE EAN Dim. PCB Qty € HT  
 XT505326004 | 3221912082732 | Droite / Finition | 1 | 2 | 9,55



**MADERA DURA MASIVA | Hoja de sierra de calar | TECHNIC**

1T50392 Blister

CODE EAN Dim. PCB Qty € HT  
 XT505326005 | 3221912082749 | Mixte / Finition | 1 | 2 | 10,34



**TECHNIC / Hoja de calar**

1T50422 Blister

CODE EAN Dim. PCB Qty € HT  
 XT505326006 | 3221912082756 | Droite / Finition | 1 | 2 | 9,55



**MATERIALES ESPECÍFICOS | Hojas de sierra de calar | TECHNIC**

1T50482 Blister

CODE EAN Dim. PCB Qty € HT  
 XT505326010 | 3221912082800 | Droite / Finition | 1 | 2 | 9,14



**MADERA BLANDA Y AGLOMERADO | Hoja de sierra de calar**

1T50402 Blister

CODE	EAN	Dim.	PCB	Qty	€ HT
XT505320031	3221910898083	Courbe / Rapide	6	2	5,13
XT505320032	3221910898090	Droite / Rapide	6	2	5,13
XT505320033	3221910898106	Courbe / Finition	6	2	5,13
XT505320036	3221910898137	Droite / Finition	6	2	5,13
XT505320037	3221910898144	Droite / Rapide	6	2	5,13
XT505320049	3221910899189	Droite / Finition	6	2	5,13

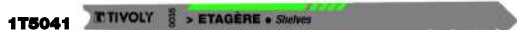

**ESTANTERÍAS | Hoja de sierra de calar**

1T50412 Blister

CODE EAN Dim. PCB Qty € HT  
 XT505320035 | 3221910898120 | Droite / Finition | 6 | 2 | 7,20



**CARPINTERÍA MADERA | Hoja de sierra de calar**

1T50512 Blister

CODE EAN Dim. PCB Qty € HT  
 XT505320038 | 3221910898151 | Droite / Finition | 3 | 2 | 9,30



**PARQUET | Hoja de sierra de calar**

1T50592 Blister

CODE EAN Dim. PCB Qty € HT  
 XT505320039 | 3221910898168 | Droite / Finition | 3 | 2 | 9,30  
 XT505320040 | 3221910898175 | Courbe / Finition | 3 | 2 | 9,30

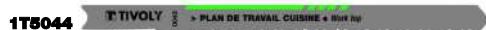

**PLAN DE TRABAJO | Hoja de sierra de calar**

1T50442 Blister

CODE EAN Dim. PCB Qty € HT  
 XT505320042 | 3221910898199 | Droite / Finition | 3 | 2 | 9,30



**PLACAS DE YESO | Hoja de sierra de calar**

XT50492 Blister

CODE EAN Dim. PCB Qty € HT  
 XT505320046 | 3221910898236 | Droite / Rapide | 3 | 1 | 13,47



**PLÁSTICO | Hoja de sierra de calar**

1T50642 Blister

CODE EAN Dim. PCB Qty € HT  
 XT505320034 | 3221910898113 | Droite / Finition | 6 | 2 | 7,20



**EMBALDOSADO | Hoja de sierra de calar**

XT50702 Blister

CODE EAN Dim. PCB Qty € HT  
 XT505320048 | 3221910898250 | Droite / Rapide | 3 | 1 | 9,30



**MULTI-MATERIALES | Hoja sierra de calar**

1T50712 Blister

CODE EAN Dim. PCB Qty € HT  
 XT505320041 | 3221910898182 | Droite / Rapide | 3 | 2 | 9,30



**CHAPA METAL | Hoja de sierra de calar**

1T50452 Blister

CODE EAN Dim. PCB Qty € HT  
 XT505320043 | 3221910898205 | Droite / Finition | 6 | 2 | 7,20  
 XT505320044 | 3221910898212 | Droite / Finition | 6 | 2 | 7,20  
 XT505320050 | 3221912252234 | Courbe / Finition | 1 | 2 | 7,20



**ALUMINIO | Hoja de sierra de calar**

└─ **1T50462** Blister

CODE EAN Dim. PCB Qty € HT  
 XT505320045 | 3221910898229 | Droite / Finition | 6 | 2 | 7,20



**1T5047** TIVOLY INOX • Stainless steel

**INOX | Hoja sierra de calar**

└─ **1T50472** Blister

CODE EAN Dim. PCB Qty € HT  
 XT505320047 | 3221910898243 | Droite / Finition | 3 | 2 | 9,30



**XT50572004311**

EAN : 3221910899257  
**5 hojas MAKITA | Madera,  
 plástico, chapa**

Madera blanda y aglomerado: 2 hojas  
 de corte A -C -D / Plástico: 1 hoja de  
 corte A -D / Chapa: 1 hoja de corte A  
 -D

Pcs : 5

**10,02 €**

**XT5100** 

**PODA | Hoja de sierra de sable | TECHNIC**

**XT51002** Funda plástico

CODE	EAN	Dim.	PCB	Qty	€ HT
XT505826001	3221912083555	Mixte / Rapide	1	2	12,81

**XT5101** 

**PLÁSTICO | Hoja de sierra de sable**

**XT51012** Funda plástico

CODE	EAN	Dim.	PCB	Qty	€ HT
XT505820101	3221910898359	Mixte / Rapide	3	2	10,52
XT505820106	3221910898403	Droite / Finition	3	2	10,52

**XT5102** 

**MULTIDIRECCIONAL | Hoja de sierra sable**

**XT51022** Funda plástico

CODE	EAN	Dim.	PCB	Qty	€ HT
XT505820109	3221912213815	Multidirection x2	1	2	20,54

**XT5103** 

**MULTI-MATERIALES | Hoja de sierra de sable**

**XT51032** Funda plástico

CODE	EAN	Dim.	PCB	Qty	€ HT
XT505820104	3221910898380	Droite / Rapide	1	2	18,09
XT505820105	3221910898397	Droite / Rapide	3	2	17,22

**XT5104** 

**MATERIALES ABRASIVOS | Hoja de sierra de sable**

**XT51042** Funda plástico

CODE	EAN	Dim.	PCB	Qty	€ HT
XT505820111	3221912218469	A C	1	2	33,96

**XT5107** 

**SUSTENTO INOX | HOJA DE SIERRA DE SABLE**

**XT51072** Funda plástico

CODE	EAN	Dim.	PCB	Qty	€ HT
XT505820113	3221912237323	A D	1	2	22,61

**XT5108** 

**Multidireccional | TECHNIC**

**XT51082** Funda plástico

CODE	EAN	Dim.	PCB	Qty	€ HT
XT505820110	3221912213822	A B C	1	2	20,54

**XT5109** 

**PODA | Hoja de sierra de sable**

**XT51092** Funda plástico

CODE	EAN	Dim.	PCB	Qty	€ HT
XT505820100	3221910898342	Mixte / Rapide	3	2	9,84
XT505820108	3221910899233	Droite / Rapide	1	2	9,84

**XT5110** 

**CHAPA METAL | Hoja de sierra de sable**

**XT51102** Funda plástico

CODE	EAN	Dim.	PCB	Qty	€ HT
XT505820102	3221910898366	Droite / Finition	1	2	11,54
XT505820103	3221910898373	Droite / Finition	3	2	11,28

**XT5111** 

**MATERIALES ABRASIVOS | Hoja de sierra de sable | AC | Esp. 6/100**

**XT51112** Funda plástico

CODE	EAN	Dim.	PCB	Qty	€ HT
XT505820107	3221910898410	Droite / Rapide	3	1	25,88

**XT5105** 

**MATERIALES AISLANTES**

**XT51052** Funda plástico

CODE	EAN	Dim.	PCB	Qty	€ HT
XT505820112	3221912218476	Droit / Finition	1	2	13,93

**XT505370001**

EAN : 3221912082664  
**10 hojas | Madera |  
 MIXTO | TECHNIC**

Pcs : 10 **26,34 €**

**XT505570002**

EAN : 3221912082695  
**10 hojas | Madera, metal |  
 MIXTO | TECHNIC**

Pcs : 10 **26,34 €**

**XT505370002**

EAN : 3221912082671  
**10 hojas | Madera, metal |  
 MIXTO | TECHNIC**

Pcs : 10 **26,34 €**

**XT505570003**

EAN : 3221912107725  
**10 hojas | Madera |  
 MIXTO**

Pcs : 10 **19,19 €**

**XT505370003**

EAN : 3221912107732  
**10 hojas | Madera**

Pcs : 10 **19,19 €**

**XT50557505500**

EAN : 3128825055009  
**10 hojas | Madera, metal |  
 MIXTO**

Pcs : 10 **6,71 €**

**XT50537505300**

EAN : 3128825053005  
**10 hojas |  
 BLACK&DECKER SKIL  
 RYOBI**

10 hojas para metal y madera

Pcs : 10 **6,71 €**

**XT50572004300**

EAN : 3128820043001  
**10 hojas adhesión T |  
 Madera, plástico, chapa |  
 MIXTO**

Madera blanda y aglomerado: 4 hojas de corte A -B -C -D / Plástico: 2 hojas de corte A -D / Estanterías: 2 hojas de corte A -S / Chapa: 2 hojas de corte A -D

Pcs : 10 **20,26 €**

**XT505570001**

EAN : 3221912082688  
**10 hojas | Madera |  
 TECHNIC**

Pcs : 10 **26,34 €**

**XT50572004304**

EAN : 3128820043049  
**10 hojas adhesión U |  
 Madera, plástico, chapa |  
 MIXTO**

Madera blanda y aglomerado: 4 hojas de corte A -B -C -D / Plástico: 2 hojas de corte A -D / Estanterías: 2 hojas de corte A -S / Chapa: 2 hojas de corte A -D

Pcs : 10 **20,26 €**

**XT50572004310**

EAN : 3128820043100

**5 hojas PEUGEOT |  
Madera, chapa | MIXTO**Madera blanda y aglomerado: 4 hojas  
de corte A -B -C -D / Chapa: 1 hoja de  
corte A -D

Pcs : 5

**10,02 €****XT505820001**

EAN : 3221912251855

**5 hojas de sierra de sable  
| Metal, plástico, poda**1 hoja madera / 2 hojas plástico / 2  
hojas chapa

Pcs : 5

**23,29 €**



**XT5015**

**RENDIMIENTO | Hoja de sierra circular | TECHNIC | Sierra portátil**



└ **XT50154** Funda cartón

CODE	EAN	Dim.	PCB	Qty	€ HT
XT505146001	3221912081582	160x20x Z 20	1	1	29,15
XT505146002	3221912081599	190x20x Z 24	1	1	35,30

**XT5016**

**ACABADO | Hojas de sierra circular | TECHNIC | Sierra portátil**



└ **XT50164** Funda cartón

CODE	EAN	Dim.	PCB	Qty	€ HT
XT505146101	3221912081605	160x20x Z 36	1	1	36,11
XT505146102	3221912081612	184x20x Z 40	1	1	41,55
XT505146103	3221912081629	190x20x Z 48	1	1	46,92

**XT5017**

**METALES NO FERROSOS | Hojas de sierra circular | TECHNIC | Sierra portátil**



└ **XT50174** Funda cartón

CODE	EAN	Dim.	PCB	Qty	€ HT
XT505146201	3221912081636	160x20x Z 42	1	1	47,36
XT505146202	3221912081643	190x30x Z 54	1	1	62,12

**1T5002**

**RENDIMIENTO | Hoja de sierra circular | Sierra portátil**



└ **1T50024** Funda cartón

CODE	EAN	Dim.	PCB	Qty	€ HT
XT50514004125	3221912261069		1	1	24,86

**XT5003**

**ACABADO | Hojas de sierra circular | Sierra portátil**



└ **XT50034** Funda cartón

CODE	EAN	Dim.	PCB	Qty	€ HT
XT50514004164	3221912006400	130x20x Z 30	1	1	26,76
XT50514004165	3221912006417	140x20x Z 30	1	1	26,76
XT50514004149	3128820041496	150x20x Z 30	1	1	28,71
XT50514004440	3128820044404	160x20x Z 30	1	1	30,11
XT50514004441	3128820044411	160x30x Z 30	1	1	30,11
XT50514004412	3128820044121	170x20x Z 30	1	1	30,94
XT50514004428	3128820044282	180x20x Z 40	1	1	38,17
XT50514004444	3128820044442	180x30x Z 40	1	1	38,17
XT50514004179	3128820041793	184x20x Z 40	1	1	39,09
XT50514004178	3221912006424	184x30x Z 40	1	1	37,94
XT50514004445	3128820044459	190x20x Z 40	1	1	39,92
XT50514004183	3128820041830	190x30x Z 40	1	1	39,92
XT50514004447	3128820044473	210x30x Z 40	1	1	40,71
XT50514004448	3128820044480	230x30x Z 40	1	1	41,65
XT50514004450	3128820044503	235x30x Z 40	1	1	41,65
XT50514004451	3221912006448	250x30x Z 48	1	1	64,17

**1T5004**

**METALES NO FERROSOS | Hojas de sierra circular | Sierra portátil**



└ **1T50044** Funda cartón

CODE	EAN	Dim.	PCB	Qty	€ HT
XT50514004465	3221912261113		1	1	52,09

**XT5007**

**ACABADO | Hojas de sierra circular | Sierra estacionaria | Sierra de mesa**



└ **XT50074** Funda cartón

CODE	EAN	Dim.	PCB	Qty	€ HT
XT50514004483	3128820044831	250x30x Z 80	1	1	49,38
XT50514004484	3128820044848	300x30x Z 96	1	1	57,93
XT50514004486	3221912006479	315x30x Z 96	1	1	74,55

**XT5012**

**ACABADO | Hojas de sierra circular | Sierra estacionaria | Sierra radial**



└ **XT50124** Funda cartón

CODE	EAN	Dim.	PCB	Qty	€ HT
XT50514004474	3128820044749	210x30x Z 80	1	1	43,23
XT50514004478	3221912006455	216x30x Z 80	1	1	45,38
XT50514004475	3128820044756	250x30x Z 80	1	1	49,38
XT50514004476	3128820044763	254x30x Z 80	1	1	49,38
XT50514004477	3128820044770	300x30x Z 96	1	1	60,29
XT50514004479	3221912006462	305x30x Z 96	1	1	71,64

**XT5013**

**METALES NO FERROSOS | Sierra estacionaria | Sierra radial y mesa**



└ **XT50134** Funda cartón

CODE	EAN	Dim.	PCB	Qty	€ HT
XT50514004491	3128820044916	250x30x Z 80	1	1	62,19
XT50514004492	3128820044923	254x30x Z 80	1	1	62,19

**XT5010**

**Maderas con cuerpos extraños | Disco para esculpir | Amoladora**



└ **XT50102** Blister

CODE	EAN	Dim.	PCB	Qty	€ HT
XT50512004535	3128820045357	115x22.2x Z 12	1	1	39,52
XT50512004545	3128820045456	125x22.2x Z 12	1	1	40,83
XT50512004555	3221912006363	180x22.2x Z 12	1	1	43,11

**1T5003**

**Hoja de sierra circular**



## 1T50034 Funda cartón

CODE	EAN	Dim.	PCB	Qty	€ HT
XT50514004449	3221912261076		1	1	40,78
XT50514004454	3221912261090		1	1	64,49

### XT5002

#### RENDIMIENTO | Hojas de sierra circular | Sierra portátil | Madera & yeso



## XT50024 Funda cartón

CODE	EAN	Dim.	PCB	Qty	€ HT
XT50514004121	3128820041212	125x20x Z 20	1	1	22,40
XT50514004126	3128820041267	130x20x Z 20	1	1	22,40
XT50514004136	3128820041366	140x20x Z 20	1	1	22,79
XT50514004148	3128820041489	150x20x Z 20	1	1	23,21
XT50514004160	3221912076304	160x16x Z 20	1	1	24,54
XT50514004163	3128820041632	160x20x Z 20	1	1	24,54
XT50514004123	3221912006370	160x30x Z 20	1	1	24,39
XT50514004431	3128820044312	170x20x Z 20	1	1	25,23
XT50514004172	3128820041724	180x20x Z 24	1	1	25,55
XT50514004171	3128820041717	180x30x Z 24	1	1	25,55
XT50514004175	3221912076311	184x16x Z 24	1	1	27,07
XT50514004184	3128820041847	184x20x Z 24	1	1	27,07
XT50514004185	3221912006431	184x30x Z 24	1	1	26,98
XT50514004182	3221912076328	190x16x Z 24	1	1	28,61
XT50514004432	3128820044329	190x20x Z 24	1	1	28,60
XT50514004434	3128820044343	190x30x Z 24	1	1	28,60
XT50514004435	3128820044350	210x30x Z 24	1	1	28,82
XT50514004436	3128820044367	230x30x Z 24	1	1	29,04
XT50514004438	3128820044381	235x30x Z 24	1	1	29,04
XT50514004453	3128820044534	250x30x Z 30	1	1	43,99

### XT5004

#### METALES NO FERROSOS | Hojas de sierra circular | Sierra portátil



## XT50044 Funda cartón

CODE	EAN	Dim.	PCB	Qty	€ HT
XT50514004129	3221912006387	156x20x Z 40	1	1	36,84
XT50514004460	3128820044602	160x20x Z 40	1	1	39,72
XT50514004461	3128820044619	180x20x Z 60	1	1	48,87
XT50514004162	3221912006394	180x30x Z 60	1	1	47,43
XT50514004411	3128820044114	184x20x Z 60	1	1	49,86
XT50514004462	3128820044626	190x30x Z 60	1	1	50,90
XT50514004463	3128820044633	210x30x Z 60	1	1	51,91

**XT3010**

**Disco de tronzado FURIUS | Metal**



└ **XT30101** Envase unidades granel

CODE	EAN	Dim.	PCB	Qty	€ HT
XT3032111115016	3221910897994	115x1,6	10	1	2,73
XT3032111125016	3221910898007	125x1,6	10	1	2,90
XT3032111230019	3221910898014	230x1,9	10	1	5,63



└ **XT30031** Envase unidades granel

CODE	EAN	Dim.	PCB	Qty	€ HT
XT30321032008	3221910899806	115	10	1	2,28
XT30321032009	3221910899813	125	10	1	2,53
XT30321032010	3221910899820	230	10	1	4,60

**XT3011**

**Disco de tronzado FURIUS | Materiales**



└ **XT30111** Envase unidades granel

CODE	EAN	Dim.	PCB	Qty	€ HT
XT3032121115016	3221910898021	115x3,2	10	1	2,39
XT3032121125016	3221910898038	125x3,2	10	1	2,54
XT3032121230019	3221910898045	230x3,2	10	1	4,93

**XT3005**

**Disco de corte | Gama "Best Sellers" | Materiales**



└ **XT30051** Envase unidades granel

CODE	EAN	Dim.	PCB	Qty	€ HT
XT30321032014	3221910899868	115x3,2	10	1	2,28
XT30321032015	3221910899875	125x3,2	10	1	2,53
XT30321032016	3221910899882	230x3,2	10	1	4,60

**XT3013**

**Disco de tronzado/desbarbado | CROSS 3en1**



└ **XT30131** Envase unidades granel

CODE	EAN	Dim.	PCB	Qty	€ HT
XT30321032017	3221910899899	125x2	10	1	4,37

**XT3004**

**Disco para desbarbar | Gama "Best Sellers" | Metal**



└ **XT30041** Envase unidades granel

CODE	EAN	Dim.	PCB	Qty	€ HT
XT30321032011	3221910899837	115	10	1	3,45
XT30321032012	3221910899844	125x7	10	1	3,65

**XT3001**

**Disco resinolde de tronzado | Especial poco espesor | Metal**



└ **XT30011** Envase unidades granel

CODE	EAN	Dim.	PCB	Qty	€ HT
XT30321032001	3221910899752	115	10	1	2,08
XT30321032002	3221910899769	125	10	1	2,28

**XT3009**

**Disco de tronzado Gama económica | Metal**



└ **XT30091** Envase unidades granel

CODE	EAN	Dim.	PCB	Qty	€ HT
XT30321090837	3128820908379	115x3,2	12	5	5,65
XT30321090839	3128820908393	125x3,2	12	5	6,68
XT30321090841	3128820908416	230x3,2	12	5	14,67

**XT3002**

**Disco para tronzado | Gama "Best Sellers" | Metal**



└ **XT30021** Envase unidades granel

CODE	EAN	Dim.	PCB	Qty	€ HT
XT30321032003	3221910899776	115	10	1	1,63
XT30321032004	3221910899783	125	10	1	1,75
XT30321032005	3221910899790	230	10	1	4,37

**XT3008**

**Disco de tronzado Gama económica | Materiales**



└ **XT30081** Envase unidades granel

CODE	EAN	Dim.	PCB	Qty	€ HT
XT30321090836	3128820908362	115x3,2	12	5	5,73
XT30321090838	3128820908386	125x3,2	12	5	6,68
XT30321090840	3128820908409	230x3,2	12	5	14,67

**XT3003**

**Disco para tronzado | Gama "Best Sellers" | Metal**

**XT3126**

**Disco DIAMANTE | Asfalto/Hormigón | Gama alto rendimiento**



└─ **XT31261** Envase unidades granel

CODE	EAN	Dim.	PCB	Qty	€ HT
XT30341034209	3221910900502	125	1	1	78,72
XT30341034210	3221910900519	230	1	1	150,62
XT30341034211	3221910900526	300	1	1	196,33

└─ **XT31251** Envase unidades granel

CODE	EAN	Dim.	PCB	Qty	€ HT
XT30341034207	3221910900489	300	1	1	111,49
XT30341034208	3221910900496	350	1	1	142,09

**XT3127**

**Disco Diamante Ø230mm | Hormigón, teja | Gama Alto Rendimiento**



**XT3124**

**Disco DIAMANTE | Multimaterial | Gama "best sellers"**



└─ **XT31271** Envase unidades granel

CODE	EAN	Dim.	PCB	Qty	€ HT
XT30341034212	3221910900533	230	1	1	126,94

└─ **XT31241** Envase unidades granel

CODE	EAN	Dim.	PCB	Qty	€ HT
XT30341034204	3221910900458	115	1	1	35,43
XT30341034205	3221910900465	125	1	1	37,95
XT30341034206	3221910900472	230	1	1	65,94

**XT3104**

**Disco DIAMANTE acero blando/hormigón | Gama alto rendimiento**



**XT3123**

**Disco DIAMANTE | Embaldosado | Gama "best sellers"**



└─ **XT31041** Envase unidades granel

CODE	EAN	Dim.	PCB	Qty	€ HT
XT30341034020	3221910883577	115	1	1	69,83
XT30341034021	3221910883584	125	1	1	96,92
XT30341034022	3221910883591	230	1	1	141,98

└─ **XT31231** Envase unidades granel

CODE	EAN	Dim.	PCB	Qty	€ HT
XT30341034200	3221910900410	115	1	1	30,17
XT30341034201	3221910900427	125	1	1	32,80
XT30341034202	3221910900434	180	1	1	49,22
XT30341034203	3221910900441	230	1	1	71,07

**XT3103**

**Disco DIAMANTE | Gres cerámico | Gama alto rendimiento**



**XT3114**

**Disco DIAMANTE hormigón | Gama económica**



└─ **XT31031** Envase unidades granel

CODE	EAN	Dim.	PCB	Qty	€ HT
XT30341034010	3221910883485	115	1	1	89,96
XT30341034011	3221910883492	125	1	1	111,12
XT30341034013	3221910896751	180	1	1	146,22
XT30341034012	3221910883508	230	1	1	171,44

└─ **XT31141** Envase unidades granel

CODE	EAN	Dim.	PCB	Qty	€ HT
XT30341034401	3128820344016	115	1	1	14,28
XT30341034402	3128820344023	125	1	1	18,64
XT30341034403	3128820344030	230	1	1	35,50

**XT3100**

**Disco DIAMANTE hormigón | Gama "Best Sellers"**



**XT3117**

**Disco DIAMANTE hormigón | Gama económica**



└─ **XT31001** Envase unidades granel

CODE	EAN	Dim.	PCB	Qty	€ HT
XT30341034001	3128820340018	115	1	1	34,78
XT30341034002	3128820340025	125	1	1	37,75
XT30341034003	3128820340032	230	1	1	82,55

└─ **XT31171** Envase unidades granel

CODE	EAN	Dim.	PCB	Qty	€ HT
XT30341113401	3128821134012	115	12	1	7,06
XT30341113402	3128821134029	125	12	1	9,15
XT30341113403	3128821134036	230	6	1	24,95

**XT3125**

**Disco DIAMANTE hormigón | Gama "Best Sellers"**

**XT3101**

**Disco DIAMANTE | Multimaterial | Gama económica**





**XT31011** Envase unidades granel

CODE	EAN	Dim.	PCB	Qty	€ HT
XT30341034004	3128820340049	115	1	1	21,65
XT30341034005	3128820340056	125	1	1	25,33
XT30341034102	3128820341022	180	1	1	23,93
XT30341034006	3128820340063	230	1	1	59,60

**XT3102**

**Disco DIAMANTE | Embaldosado | Gama económica**



**XT31021** Envase unidades granel

CODE	EAN	Dim.	PCB	Qty	€ HT
XT30341034007	3128820340070	115	1	1	14,65
XT30341034008	3128820340087	125	1	1	17,14
XT30341034101	3128820341015	180	1	1	24,74
XT30341034009	3128820340094	230	1	1	32,30

**XT3118**

**Disco DIAMANTE | Embaldosado | Gama económica**



**XT31181** Envase unidades granel

CODE	EAN	Dim.	PCB	Qty	€ HT
XT30341113407	3128821134074	115	12	1	6,71
XT30341113408	3128821134081	125	12	1	8,40
XT30341113409	3128821134098	230	6	1	21,77

**XT3105**

**Disco para ranurar**



**XT31051** Envase unidades granel

CODE	EAN	Dim.	PCB	Qty	€ HT
XT30341034050	3221910883539	125	1	1	59,98
XT30341034051	3221910883546	150	1	1	77,14

**XT3106**

**Disco para desensamblar**



**XT31061** Envase unidades granel

CODE	EAN	Dim.	PCB	Qty	€ HT
XT30341034060	3221910883515	115	1	1	131,72
XT30341034061	3221910883522	125	1	1	152,88

**XT3107**

**Disco para pulir**



**XT31071** Envase unidades granel

CODE	EAN	Dim.	PCB	Qty	€ HT
XT30341034070	3221910883553	125	1	1	100,55
XT30341034071	3221910883560	180	1	1	124,95

**XT3119**

**Kit de 3 discos Diamante Ø115mm**



**XT31192** Blister

CODE	EAN	Dim.	PCB	Qty	€ HT
XT30342090315	3128820903152	115	12	5	16,79

**XT3120**

**Kit de 3 discos Diamante Ø125mm**



**XT31202** Blister

CODE	EAN	Dim.	PCB	Qty	€ HT
XT30342090325	3128820903251	125	12	5	21,65



**XT6101** 

**Fresa para ranurar | Canal recto | 2 filos rectificados con diamante**

**XT61012** Blister

CODE	EAN	Dim.	PCB	Qty	€ HT
XT60642067831	3221912089625	3	1	1	12,74
XT60642067832	3128820678326	4	1	1	13,49
XT60642067833	3221912089632	5	1	1	13,49
XT60642067834	3128820678340	6	1	1	13,49
XT60642067835	3128820678357	8	1	1	13,49
XT60642067836	3128820678364	10	1	1	15,67
XT60642067837	3128820678371	12	1	1	15,67
XT60642067838	3128820678388	14	1	1	15,67
XT60642067839	3221912089649	15	1	1	15,67
XT60642067840	3128820678401	16	1	1	17,68
XT60642067841	3128820678418	18	1	1	17,68
XT60642067842	3128820678425	20	1	1	17,68
XT60642067844	3221912089656	22	2	1	19,78
XT60642067847	3221912089663	25	1	1	19,78
XT60642067320	3128820673208	4-6-8	1	3	34,47



CODE	EAN	Dim.	PCB	Qty	€ HT
XT60642067802	3128820678029	12.7	1	1	18,48



**XT6111**

**Fresa para encajar + guía**



**XT61112** Blister

CODE	EAN	Dim.	PCB	Qty	€ HT
XT60642067807	3128820678074	31.8	1	1	18,48



**XT6103**

**Sierra para ranurar**



**XT61032** Blister

CODE	EAN	Dim.	PCB	Qty	€ HT
XT60642067867	3221912089670	40	2	1	15,67
XT60642067868	3221912089687	40	2	1	15,67
XT60642067866	3128820678661	40	1	1	15,67



**XT6104** 

**Fresa para acanalar**

**XT61042** Blister

CODE	EAN	Dim.	PCB	Qty	€ HT
XT60642067845	3128820678456	16	1	1	17,68



**XT6105** 

**Fresa para ranurar en V**

**XT61052** Blister

CODE	EAN	Dim.	PCB	Qty	€ HT
XT60642067846	3128820678463	12.7	2	1	17,68



**XT6110**

**Fresa para biselar + guía**



**XT61102** Blister

CODE	EAN	Dim.	PCB	Qty	€ HT
XT60642067806	3128820678067	32	1	1	18,48
XT60642067810	3221912089618	45	1	1	25,36



**XT6106** 

**Fresa con mango para redondear**

**XT61062** Blister

CODE	EAN	Dim.	PCB	Qty	€ HT
XT60642067861	3128820678616	14.3	1	1	15,67



**XT6112** 

**Fresa 1/4 de radio**

**XT61122** Blister

CODE	EAN	Dim.	PCB	Qty	€ HT
XT60642067809	3128820678098	29	1	1	19,12
XT60642067811	3221912089564	32	1	1	21,91
XT60642067812	3221912089571	38	1	1	23,20
XT60642067813	3221912089595	44	2	1	31,69



**XT6107**

**Fresa con garganta + guía**



**XT61072** Blister

CODE	EAN	Dim.	PCB	Qty	€ HT
XT60642067801	3128820678012	31.8	2	1	18,48



**XT6108** 

**Fresa para enrasar + guía**

**XT61082** Blister



**XT60642067300**  
 EAN : 3128820673000  
**3 fresas para ranurar derecha | 2 filos rectificados (blister)**  
 Ø4mm H8mm / Ø8mm H20mm / Ø6mm H16mm

Pcs : 3 **34,47 €**



**XT60642067305**  
 EAN : 3128820673055  
**3 fresas para ranurar derecha | 2 filos rectificados (blister)**  
 Ø10mm H20mm / Ø20mm H20mm / Ø14mm H20mm

Pcs : 3 **39,81 €**

**XT60642067325**

EAN : 3128820673253

**3 fresas para ranurar  
derecha | 2 filos  
rectificados (blíster)**Ø10mm H20mm / Ø14mm H20mm /  
Ø12mm H20mm

Pcs : 3

**39,81 €****XT60642067330**

EAN : 3128820673307

**3 fresas para ranurar  
derecha | 2 filos  
rectificados (blíster)**Ø16mm H20mm / Ø20mm H20mm /  
Ø18mm H20mm

Pcs : 3

**45,02 €****XT60642067335**

EAN : 3128820673352

**3 fresas para ranurar  
derecha | 2 filos  
rectificados (blíster)**Ø6mm H16mm / Ø20mm H20mm /  
Ø10mm H20mm

Pcs : 3

**39,81 €**

**XT606470005**

EAN : 3221912233738  
**12 fresas de fresadora en  
 varias formas | Mango de  
 6mm | Especial  
 recortadora**

12 fresas de fresadora / 3 fresas para  
 ranurar Ø8mm -10mm -16mm / 2  
 fresas para moldear Ø35x18mm  
 -35x12,7mm / 1 fresa con mango para  
 redondear 14° 12,7x13mm / 1 fresa  
 para biselar Ø30x13mm / 1 fresa  
 cuarto de radio Ø31,8x16mm r9,5mm /  
 1 fresa para ranurar en V 90°  
 Ø12,7x10mm / 1 fresa para acanalar  
 Ø15,8x12,7mm r7,9mm / 1 fresa para  
 encajar Ø32x10mm / 1 fresa para  
 enrasar Ø12,7x25mm + Guía

Pcs : 12 **62,37 €**

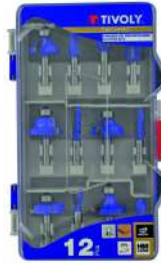
**XT606470003**

EAN : 3221912132406  
**12 fresas de fresadora en  
 varias formas | Mango de  
 8mm**

3 fresa para ranurar Ø8mm -10mm  
 -16mm / 1 fresa para moldear  
 Ø35x18mm Ø35x12,7mm / 1 fresa con  
 mango para redondear 14°  
 12,7x13mm / 1 fresa para biselar  
 Ø30x13mm / 1 fresa cuarto de radio  
 Ø31,8x16mm r9,5mm / 1 fresa para  
 ranurar en V 90° Ø12,7x10mm / 1 fresa  
 para acanalar Ø15,8x12,7mm r7,9mm /  
 1 fresa para encajar Ø32x10mm /  
 1 fresa para enrasar Ø12,7x25mm +  
 Guía

Pcs : 12 **62,37 €**

**XT606470006**

EAN : 3221912233745  
**6 fresas de fresadora en  
 varias formas | Mango de  
 6mm | Especial  
 recortadora**

2 fresa para ranurar Ø10mm -12mm / 1  
 fresa con mango para redondear 14°  
 12,7x13mm / 1 fresa para biselar  
 Ø30x13mm 45° / 1 fresa cuaro de  
 radio Ø31,8x16mm r9,5mm / 1 fresa  
 para acanalar Ø15,8x12,7mm r7,9mm

Pcs : 6 **41,19 €**

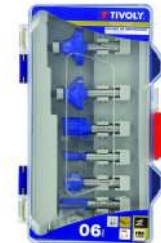
**XT606470004**

EAN : 3221912233721  
**6 fresas de fresadora en  
 varias formas | Mango de  
 8mm**

1 fresa para ranurar Ø10mm -20mm / 1  
 fresa con mango para redondear 14°  
 12,7x13mm / 1 fresa para biselar  
 Ø30x13mm 45° / 1 fresa cuarto de  
 radio Ø31,8x16mm r9,5mm / 1 fresa  
 para acanalar Ø15,8x12,7mm r7,9mm

Pcs : 6 **41,19 €**

**XT606470001**

EAN : 3221912117519  
**5 fresas de fresadora  
 para ranurar | Mango de  
 8mm**

Ø4mm -5mm -6mm -8mm -10mm

Pcs : 5 **40,06 €**

**XT60647064012**

EAN : 3128820640125  
**12 fresas de fresadora**

Pcs : 12 **31,69 €**

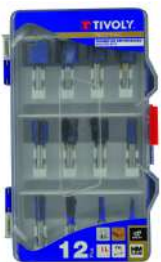
**XT606470002**

EAN : 3221912132383  
**12 fresas de fresadora  
 para ranurar | Mango de  
 8mm**

Ø5mm -6mm -8mm -10mm -12mm  
 -14mm -15mm -16mm -18mm -20mm  
 -22mm -25mm

Pcs : 12 **60,79 €**

**XT60642064006**

EAN : 3128820640064  
**6 fresas de fresadora**

Pcs : 6 **18,63 €**

**XT6115**

**Casquillo de reducción**

└ **XT61152**

CODE	EAN	Dim.	PCB	Qty	€ HT
XT60642067598	3128820675981	6 > 8	1	1	13,49
XT60642067599	3128820675988	8 > 12	2	1	13,49



**XT6102**

**Husillo | Para sierra para ranurar**

└ **XT61022**

CODE	EAN	Dim.	PCB	Qty	€ HT
XT60642067863	3128820678630	6	1	1	12,81





**Botador de clavijas**

└─ **1110102** Blister

CODE	EAN	Dim.	PCB	Qty	€ HT
11101020002	3221910899103	5-6-8	1	3	6,19
11101020003	3221910899110	2-3-4	1	3	5,25
11101020200	3221910016500	2	3	1	2,01
11101020300	3221910016517	3	3	1	2,01
11101020400	3221910016524	4	3	1	2,05
11101020500	3221910016531	5	3	1	2,05
11101020600	3221910016548	6	3	1	2,53



**Botadores cónicos**

└─ **1110162**

CODE	EAN	Dim.	PCB	Qty	€ HT
11101620001	3221910836177	2-3-4-5	1	4	7,03
11101620200	3221910016593	2	3	1	2,02
11101620300	3221910016609	3	3	1	2,02
11101620400	3221910016616	4	3	1	2,02
11101620500	3221910016623	5	3	1	1,99



**Punzones**

└─ **1110132**

CODE	EAN	Dim.	PCB	Qty	€ HT
11101320001	3221910836146	8-12	1	1	4,46
11101320002	3221910836153	9-10	1	2	4,05
11101320003	3221910899127	7-8	1	2	3,51
11101320004	3221910899097	12-14	1	2	6,15
11101320700	3221910222574	7	3	1	2,01
11101320800	3221910016463	8	3	1	2,05
11101320900	3221910016470	9	3	1	2,13
11101321000	3221910016487	10	1	1	2,53



**Taponadores**

└─ **1110142**

CODE	EAN	Dim.	PCB	Qty	€ HT
11101420400	3221910016647	4	3	1	2,67
11101420500	3221910016654	5	3	1	2,67
11101420600	3221910016661	6	3	1	2,67



**Sacabocados**

└─ **1110202**

CODE	EAN	Dim.	PCB	Qty	€ HT
11102020001	3221910836184	2-3-4-5	1	4	8,46
11102020002	3221910836191	6-8-10	1	3	8,93
11102020200	3221910016968	2	3	1	2,31
11102020300	3221910016975	3	3	1	2,32
11102020400	3221910016982	4	3	1	2,49
11102020500	3221910016999	5	3	1	2,62
11102020600	3221910017002	6	3	1	2,81
11102020700	3221910017019	7	1	1	2,91
11102020800	3221910017026	8	1	1	3,51
11102021000	3221910017040	10	1	1	3,94



**Sacabocados**

└─ **1110212**

CODE	EAN	Dim.	PCB	Qty	€ HT
11102120001	3221910017088	2-3-4-5-6	1	5	9,83
11102120002	3221910017095	6-7-8-9-10	1	5	15,70

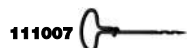

111007

**Barrenas**

└─ **1110072** Enganche plástico

CODE	EAN	Dim.	PCB	Qty	€ HT
11100720200	3221910018177	2	6	1	2,81
11100720204	3221910018269	2-4	1	2	4,74
11100720300	3221910018184	3	6	1	2,96
11100720305	3221910018276	3-5	1	2	5,42
11100720400	3221910018191	4	6	1	3,30
11100720500	3221910018207	5	1	1	3,88
11100722345	3221910081263	2-3-4-5	1	4	9,63



**Puntal extensible**

└─ **XT70021**

CODE	EAN	Dim.	PCB	Qty	€ HT
XT70711001550	3221910883607	160 - 290	12	1	53,61
XT70711001551	3221910897734	75 - 125	12	1	44,67

**11103120001**

EAN : 3221910016364  
**Taponadores de Ø4 a 7mm**

Ø4mm -5mm -6mm -7mm

Pcs : 4 **9,36 €**

**11102720001**

EAN : 3221910019204  
**Punta para trazar L145mm**

Pcs : 1 **6,00 €**

**11101720001**

EAN : 3221910866648  
**Varilla magnética L62mm**

Pcs : 1 **6,52 €**

**1111021234**

EAN : 3221910813659  
**Extractor de clavos Ø2,2-3-3,3-4,7mm**

N°1-2-3-4 Ø3>20mm

Pcs : 4 **12,07 €**



**1111120002**

EAN : 3221910824556  
**Extractor de tornillos  
 N°2-3**

N°2-3 Ø2&gt;8mm

Pcs : 2 **12,90 €****1110520001**

EAN : 3221912199775  
**T-GUN para taladro  
 atornillador inalámbrico**

Pcs : 1 **64,42 €****1111120004**

EAN : 3221912243546  
**Extractor de tornillos  
 dañados**

N°2 -3 Ø4&gt;8mm

Pcs : 2 **12,71 €****XT70017621300**

EAN : 893264000196  
**Portabrocas angular  
 universal 360° Ø2>13mm**

Pcs : 1 **76,38 €****11111070001**

EAN : 3221912117502  
**6 piezas: 5 extractores de  
 clavos y tornillos + 1 Xout  
 N°2 | TECHNIC**

Extractores N°1 -2 -3 -4 -5 + Xout de Ø2 a 8mm

Pcs : 6 **14,27 €****XT70017621390**

EAN : 893264000202  
**Portabrocas angular  
 universal 90° Ø1,5>13mm**

Pcs : 1 **42,74 €****1110220004**

EAN : 3221912193582  
**Guía taladrado PILOT4 de  
 Ø4 a 12mm**

Pcs : 1 **10,27 €****XT70017621400**

EAN : 893264000301  
**Guía de corte**

Pcs : 1 **20,19 €****1110220005**

EAN : 3221912193575  
**Guía taladrado PILOT5 de  
 Ø4 a 12mm**

Pcs : 1 **11,30 €****XT60692000271**

EAN : 3128820002718  
**Llave de portabrocas  
 universal**

Ø115-125-230mm

Pcs : 1 **8,62 €**

XT6037

Portabrocas | Autoapriete | Plástico



XT60372

CODE	EAN	Dim.	PCB	Qty	€ HT
XT60692000518	3128820005184	1,5 > 10	1	1	40,34
XT60692000519	3128820005191	2 > 13	1	1	40,05
XT60692000520	3128820005207	0,8 > 10	1	1	40,67



XT6038

Mandrill | Con llave | Metálico



XT60352

CODE	EAN	Dim.	PCB	Qty	€ HT
XT60692000018	3128820000189	1,5 > 13	1	1	31,01
XT60692000543	3128820005436	1,5 > 13	1	1	26,92



XT6040

Llave para portabrocas



XT60402

CODE	EAN	Dim.	PCB	Qty	€ HT
XT60692000255	3128820002558	8 > 10	3	1	3,63
XT60692000256	3128820002565	13	3	1	4,20
XT60692000282	3128820002824	16	3	1	11,14



XT60692003001

EAN : 3128820030018  
**Portabrocas para  
 atornillador eléctrico  
 Ø0,5>6mm**

Pcs : 1

12,53 €



XT60692000254

EAN : 3128820002541  
**Adaptador SDS+ Ø13mm**

Pcs : 1

9,98 €



XT60692000257

EAN : 3221910923648  
**Llave de portabrocas  
 universal Ø10-13-16mm**

Pcs : 1

8,84 €



XT60692000540

EAN : 3128820005405  
**Portabrocas con auto-  
 apriete SDS+ Ø2>13mm**

Pcs : 1

24,54 €



XT60692000546

EAN : 3128820005467  
**Portabrocas SDS+ con  
 llave Ø1,5>13mm**

Pcs : 2

18,10 €

**XT60682000673**EAN : 3128820006730  
**Mezclador de pintura  
L350mm**Pcs : 1 **4,72 €****XT60683000320**EAN : 3128820003203  
**Mezclador materiales  
líquidos L400mm**Pcs : 1 **17,82 €****XT60683000339**EAN : 3128820003395  
**Mezclador materiales  
líquidos L400mm**Pcs : 1 **11,85 €****XT60683000399**EAN : 3128820003999  
**Mezclador materiales  
espesos L400mm**Pcs : 1 **24,22 €****XT60683000340**EAN : 3128820003401  
**Mezclador materiales  
espesos L400mm**Pcs : 1 **10,39 €****XT60681500340**EAN : 3128825003406  
**Mezclador materiales  
espesos L400mm**Pcs : 1 **8,29 €****XT60683000341**EAN : 3221910899479  
**Mezclador materiales  
espesos L600mm**Pcs : 1 **16,04 €**

**XT6015**

**Kit de ensamble**



**XT60152**

CODE	EAN	Dim.	PCB	Qty	€ HT
XT60632000433	3128820004330	6	3	31	7,97
XT60632000434	3128820004347	8	3	20	9,30
XT60632000435	3128820004354	10	3	16	10,49



**XT6017**

**Ejes**



**XT60174**

CODE	EAN	Dim.	PCB	Qty	€ HT
XT60634000648	3128820006488	6	6	100	3,95
XT60634000649	3128820006495	8	6	75	3,95
XT60634000650	3128820006501	10	6	60	3,95
XT60634000883	3128820008833	6	6	50	2,55
XT60634000884	3128820008840	8	6	40	2,55
XT60634000885	3128820008857	10	6	30	2,55



**XT6018**

**Espigas**



**XT60184**

CODE	EAN	Dim.	PCB	Qty	€ HT
XT60634063000	3128820630003	10L45	6	50	7,52
XT60634063010	3128820630102	10L55	6	50	7,65
XT60634063020	3128820630201	20	6	50	8,07



**XT60632000689**  
 EAN : 3128820006891  
**Topes de profundidad Ø6-8-10mm**



Pcs : 3 **5,53 €**

**XT60632000794**  
 EAN : 3128820007942  
**Guía de ensamble Ø6-8-10mm**



Pcs : 1 **71,29 €**

**XT60632000436**  
 EAN : 3221912218896  
**Centradores Ø6-8-10mm**



Pcs : 6 **4,18 €**

**XT60632000432**  
 EAN : 3128820004323  
**Centradores Ø10mm**



Pcs : 4 **2,92 €**

**XT60612000216**EAN : 3128820002169  
**Sierra circular Ø45mm**Pcs : 1 **12,30 €****XT60672000249**EAN : 3128820002497  
**Broca cónica ampli-  
agujeros de Ø6 a 24mm**Pcs : 1 **19,41 €****XT60672000265**EAN : 3128820002657  
**Escofina esférica Ø15mm**Pcs : 1 **5,31 €****XT60672000501**EAN : 3128820005016  
**Escofina punta plana  
Ø6mm**Pcs : 1 **7,56 €****XT60672000505**EAN : 3128820005054  
**Escofina punta redonda  
Ø6mm**Pcs : 1 **7,44 €****XT60672000506**EAN : 3128820005061  
**Escofina cilíndrica  
Ø15mm**Pcs : 1 **5,11 €****XT60672000509**EAN : 3128820005092  
**Escofina cilíndrica  
Ø15mm**Pcs : 1 **7,44 €****XT60672000512**EAN : 3128820005122  
**Escofina punta ojiva  
Ø12mm**Pcs : 1 **9,75 €****XT60672000521**EAN : 3128820005214  
**Perforador/cortador  
Ø6mm**Pcs : 1 **3,79 €****XT60672000522**EAN : 3128820005221  
**Escofina cónica Ø15mm**Pcs : 1 **5,11 €**



**XT6020**



**Hojas reversibles**

└ **XT60202**

CODE	EAN	Dim.	PCB	Qty	€ HT
XT60642000180	3128820001803	75	1	2	17,92
XT60642000181	3128820001810	82	1	2	17,92



**XT60682000221**

EAN : 3128820002213

**Bomba de turbina  
700litros/hora**

Pcs : 1

**17,73 €****XT60682000619**

EAN : 3128820006198

**Bomba con rotor de 2400  
a 3000litros/hora**

Pcs : 1

**42,78 €**