



1989-2019 30 YEARS UK MANUFACTURING

NightSearcher Celebrating 30 years

NightSearcher started in 1989 with a clear goal; to provide high performance, easy to use portable, rechargeable lighting solutions for sectors with strict requirements, and situations where reliable lighting is critical yet not easily accessible. 30 years on, we are the leading designer, manufacturer and supplier of professional portable LED floodlights, searchlights, flashlights, work lights, and head torches.

NightSearcher LED lights are used and trusted all over the world by a wide variety of commercial and industrial users, from emergency services, armed forces, and the police to railways, industrial, and construction sectors, among others.

As manufacturers, we are constantly developing new and enhancing existing products. When designing our new lights, we aim to surpass ourselves every single year: We want our LEDs to be brighter, our batteries to last longer, and our beams to reach further. Our guiding principle, however, remains unchanged: We listen to our customers, designing our lighting systems to meet their needs.

By any definition, 30 years in business is a long time, but we feel like we've just started. We will continue to embrace leading-edge innovation and engineering in the quest to make our products even better, and to provide lighting where it's needed the most.

We'd like to thank all our customers for the support given over the past 30 years and look forward to being of service for the coming years!

Colin Howard Managing Director



CONTENTS



**Rechargeable Floodlights
and Work Lights**
P6- P23



Mains AC Lights
P24- P27



Site Lights
P28- P33



Rechargeable Searchlights
P34- P45



Professional Flashlights
P46- P61



Forensic Lighting
P62- P63



Professional Head Torches
P64- P71



**SAFATEX
Intrinsically Safe Atex Lights**
P72- P82



Automotive Lights
P83- P94



Warning Lights
P95- P99



Solar Powered Lights
P100- P105



Outdoor Lights
P106- P107

Rechargeable Warning Lights



Pulsar Max SQ P97

Sequential rechargeable hazard lights, compliant with Traffic Signs Regulations and General Directions 2016.

Site Lighting



Lunar Star P29

Ideal for industrial & construction sites. Fitted with two 110V 16A socket outlets, to power tool or link lights together.

Bluetooth Music Player and Rechargeable Floodlights



Bluetooth
MUSIC WHILE YOU WORK

BeatLite 500 P18

BeatLite 2000X P19

Robust, fully portable work lights
Listen to music while you work.

Atex Rechargeable LED Searchlight



SAFATEX SL P73

Certified according to ATEX for safe use in hazardous areas Zone 0 (Gas) and Mining Approved.

Rechargeable LED Floodlight

Rechargeable LED Searchlights



Solaris Pro P6

Probably the best rechargeable floodlight in the world. Ultimate power & performance 16,000 lumens.



HawkStar P34

Designed and tested to safely stay in charging bracket in a 70mph car crash.



ProStar Lite P36

High powered Searchlight + Floodlight. Lightweight version of the successful ProStar.



Solar Panel P102

Flexible, foldable solar panel to recharge a range of NightSearcher products.

NEW Solaris Pro and Solaris Pro-X 16K

NightSearcher

RECHARGEABLE LED FLOODLIGHTS

Quick and easy setup
4 level adjustment



DIGITAL DISPLAY:

- Set a runtime hours you require
- Select Wide or Narrow beam
- Select High, Medium, Low light mode
- Battery status indicator



Stability ground pegs for
use on a slope or uneven
terrain environment

Fold out stability feet,
can be used in high winds
and uneven terrain environments



Heavy duty shoulder strap
and carry handle for easy
transportation



NEW Solaris Pro and Solaris Pro-X 16K

16,000 Lumens - Portable Rechargeable, Programmable LED Lighting System

The Solaris Pro is the latest addition to the renown NightSearcher Solaris floodlight range. It is highly portable, extremely compact and light weight. Due to the multi position telescopic pole and light head, along with stabilising legs it can be used on uneven ground for example a motorway or railway embankment. The 16,000 lumen light output will provide a wide spread of light and can run for up to 48 hours. The control console allows for the running time to be set as needed so that the Solaris Pro will set the light level to last the required time.

NightSearcher

RECHARGEABLE LED FLOODLIGHTS

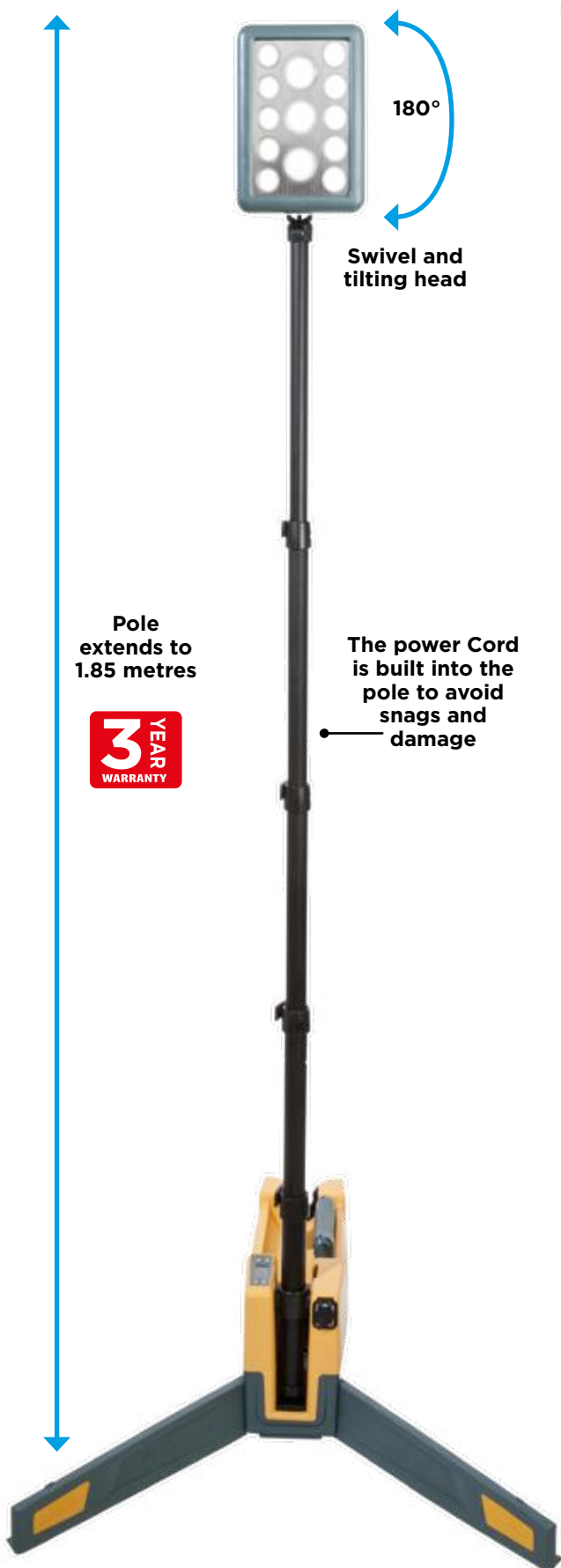

Pole extends to 1.85 metres



The power Cord is built into the pole to avoid snags and damage

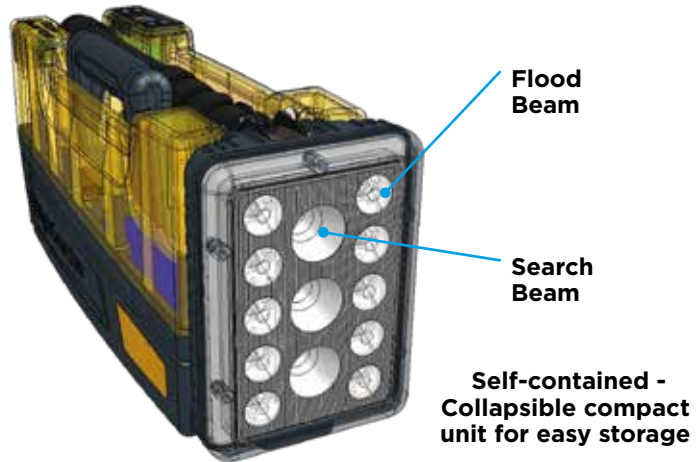

KEY FEATURES:

- 16,000 Lumens
- 500 metre beam
- Runs up to 48 hours
- Battery status indicator
- Programmable Run times - Set the correct runtime hours you require
- Stability feet & Stability ground pegs for uneven terrain
- Tough ABS plastic construction
- Shoulder strap for easy transportation
- Folds down to compact size
- Swivel and tilting head
- Weights only 7kg
- IP65 Weatherproof

2 MODELS AVAILABLE:

SOLARIS PRO OR **SOLARIS PRO-X**
 18Ah Lithium Battery 36Ah Lithium Battery

SOLARIS PRO	100% BOOST	100% SEARCH	100% FLOOD	7 KG
RUN TIMES	2.25hrs	6hrs	3.75hrs	

PRODUCT CODE: NSSOLARISPRO

SOLARIS PRO-X	100% BOOST	100% SEARCH	100% FLOOD	8.5 KG
RUN TIMES	4.5hrs	12hrs	7.5hrs	

PRODUCT CODE: NSSOLARISPRO-X

Can be programmed to run for 24 hours

LIGHT OUTPUT	100% BOOST 16,000 LUMENS	100% SEARCH 5,000 LUMENS	100% FLOOD 11,000 LUMENS
Beam	500 METRES		
RECHARGEABLE LITHIUM BATTERY	CHARGING TIME 6 HRS	IP65 RATING	DIMENSIONS 517mm x155mm x220mm

Solaris Duo Li-ion 40K/2 x 20K Heads

NightSearcher

RECHARGEABLE LED FLOODLIGHTS



See the Solaris Duo video



Solaris Duo Li-ion 40K/2 x 20K Heads

40,000 Lumens Rechargeable Lighting System

The new improved 40,000 Solaris Duo is truly the best replacement for generator powered halogen lights as they are fully portable, emit no noise or emissions and run cool making them safe for confined spaces. All units can be fully assembled in seconds for emergency situations.



3 YEAR WARRANTY

25 YEAR CASE WARRANTY

Stability feet



Extendable handle and wheels.

KEY FEATURES:

- 40,000 lumens - 2 x 20,000 heads
- 50 metre beam
- Runs up to 24 hours
- Rechargeable lithium battery
- Built in stability feet
- Battery status indicator
- Housed in a highly robust IP65 polycarbonate case
- Swivel and tilting heads
- Sturdy and stackable
- 2 x 1.9 metre extension poles

50Ah Lithium Battery

LIGHT OUTPUT	40,000 LUMENS	20,000 LUMENS	8,000 LUMENS	4,000 LUMENS
Beam	50 METRES	37.5 METRES	25 METRES	12.5 METRES
RUN TIMES	3hrs	6hrs	12hrs	24hrs
RECHARGEABLE LITHIUM BATTERY	IP65 RATING	CHARGING TIME 12HRS	DIMENSIONS 280mm x 380mm x 570mm	21 KG

PRODUCT CODE: NSSOLARISDUO20K-LI-ION-50
CAT/PAD: 0111/112259



Everything stores inside case
Quick lock/release

NEW Optional accessories:



Folding solar panel charger
Go to Page 102 for more information
PRODUCT CODE: SPSOLARPANEL



5 Way Multi Charger
Li-ion 16.8V
CH5WAYLI-ION
CAT/PAD: 0111/114510



Diffused colour filters
SPSOLARILENS-SET

NEW Sports Star 20K

ALL THE KIT FITS IN A RED WEATHERPROOF SPORTS BAG.

98 x 20 x 20cm (Approx. 38" x 8" x 8")



Whole kit in bag weighs 11.5 kg

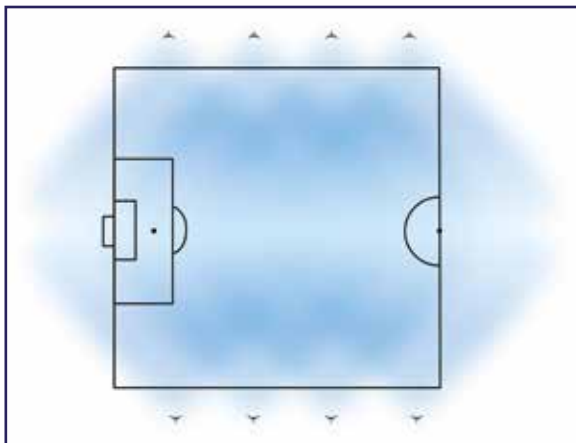

Eight units will illuminate a 60 x 40m area (a standard size of a sports training pitch/half a full sized football pitch).



Bag size:
98 x 20 x 20cm

The sports bag easily fits in the boot of a car, with shoulder straps and carry handles for easy transportation.

NEW Sports Star 20K

20,000 Lumen Rechargeable Sports Floodlighting Kit

The Sport Star is the newest Sports Floodlight in our range and has been designed to give maximum performance with safety in mind. With its new Air Cushioned 3.5m aluminium tripod it is now very safe to use, the 4 sections will collapse down safely and slowly to a compact 96cm length. It's supplied with a weatherproof kit bag with light head, tripod, battery pack and other accessories which easily fits into the boot of most cars.

Sport Star

KEY FEATURES:

- 20,000 lumens
- 4 Section air cushioned safety tripod
- Lightweight lithium rechargeable battery pack
- Easy to carry and store, runs up to 16 hours
- Fully rechargeable means no expensive, noisy generator required
- No planning permission required
- Easy set up
- Impact resistant light head
- Perfect for outdoor use in all weathers
- Low level cable control switch for light settings
- Easily fits in boot of car



18Ah Lithium Battery

LIGHT OUTPUT	20,000 LUMENS	10,000 LUMENS	4,000 LUMENS	2,000 LUMENS
Beam	50 METRES	37.5 METRES	25 METRES	12.5 METRES
RUN TIMES	2hrs	4hrs	8hrs	16hrs
RECHARGEABLE LITHIUM BATTERY	IP44 RATING	CHARGING TIME 8HRS	DIMENSIONS 98x20x20cm	11.5 KG

PRODUCT CODE: NSSPORTSTAR

See the Sport Star video

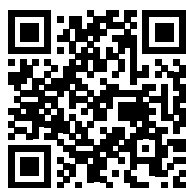

[Video link](#)

Kit includes:



New improved optics



18Ah Lithium battery pack



3 x Stability ground pegs included.



EXTENDS TO 3.5m COLLAPSES TO 0.96m
AIR CUSHIONED SAFETY TRIPOD

4 Section air cushioned safety tripod. Very safe to dismantle.

Solaris Lite 20K

Portable Lightweight Rechargeable LED Floodlight

The new improved 20,000 lumen Solaris Lite range uses the latest in LED technology, providing a powerful portable unit. This unit can be set up in less than 1 minute for rapid deployment in emergency situations, and is made from very tough ABS plastic to ensure long operating life and reliability for all situations.



3
YEAR
WARRANTY

KEY FEATURES:

- 20,000 Lumens
- 50 metre beam
- Runs up to 16 hours
- Battery status Indicator
- Storage compartment
- Shoulder strap for easy transportation
- Compact design
- Set up in seconds
- Swivel and tilting head
- Lightweight and weatherproof
- Tough ABS plastic construction
- 1.86 metre extension pole

22Ah SLA Battery

LIGHT OUTPUT	20,000 LUMENS	10,000 LUMENS	4,000 LUMENS	2,000 LUMENS
Beam	50 METRES	37.5 METRES	25 METRES	12.5 METRES
RUN TIMES	2hrs	4hrs	8hrs	16hrs
RECHARGEABLE SLA BATTERY	IP65 RATING	CHARGING TIME 8HRS	12.8 KG	

PRODUCT CODE: NSSOLARISLITE20K-SLA-22

See the Solaris Lite video

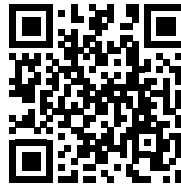

[Video link](#)



DIMENSIONS: Head Size - 248x300x58mm
Case Size - 140x250x180mm
Boxed Size - 460x460x320mm

Optional accessories:



Stability legs
increase height and
stability to 1.7m:
SPSOLARISLEGMK2



Diffused colour filters
SPSOLARISLENS-SET



5-Way Multi Charger
For SLA Batteries
CH5WAY



Solaris Megastar + Solaris Maxi 20K

Rechargeable LED Floodlights For The Emergency Services

The new improved 20,000 Solaris Megastar and Maxi floodlights are quick and easy to setup and can illuminate the crime scene for up to 28 hours. These robust weatherproof lights are used by the police, fire and rescue teams and utility groups, they are ideal for illuminating an area up to 50 metres and safe for outdoor work.

Two Stand Choices



Solaris MegaStar

Tripod which extends to 3.5 metres



Solaris Maxi

Compact design, folds down to 40cm.

Telescopic poles which extends to 1.5 metres



KEY FEATURES:

- 20,000 lumens
- 50 metre beam
- Rechargeable battery pack which runs up to 28 hours means no expensive, noisy generator required
- Quick and easy to assemble
- Virtually unbreakable polyethylene casing with polycarbonate lens
- Coiled lead to avoid trip hazards
- Adjustable 4 section pole with safety pins
- Battery status indicator
- Robust weatherproof construction
- Easy to transport and store
- Lightweight aluminium

2 Battery sizes available:

24Ah SLA Battery

	20,000 LUMENS	10,000 LUMENS	4,000 LUMENS	2,000 LUMENS
	50 METRES	37.5 METRES	25 METRES	12.5 METRES
	2hrs 15MIN	4hrs 30MIN	9hrs	18hrs

PRODUCT CODE: NSSOLARISMAXI20K-SLA-24
PRODUCT CODE: NSSOLARISMEGA20K-SLA-24

38A SLA Battery

	20,000 LUMENS	10,000 LUMENS	4,000 LUMENS	2,000 LUMENS
	50 METRES	37.5 METRES	25 METRES	12.5 METRES
	2/3hrs 30MIN	7hrs	14hrs	28hrs

PRODUCT CODE: NSSOLARISMAXI20K-SLA-38
PRODUCT CODE: NSSOLARISMEGA20K-SLA-38



Galaxy Pro

NightSearcher

RECHARGEABLE LED WORK LIGHTS



See the Galaxy Pro video



[Video Link](#)



Change the angle to suit your need



Built in storage compartment to conveniently store charger.

OPTIONAL ACCESSORY: **NEW**

Folding solar panel charger. Go to Page 102 for more information
SPSOLARPANEL



Galaxy Pro

Powerful Robust Rechargeable LED Work Light

The Galaxy Pro is designed using the toughest composite materials for use in industrial applications where it is essential to have robust products. Utilising the very latest LED technology the Galaxy Pro produces a very impressive 3500 Lumens output and giving an evenly spread of light projected to 30 metres.



KEY FEATURES:

- 3,500 Lumens
- 30 metre beam
- Runs up to 24 hours
- Rechargeable lithium battery - 7.4V 13.2Ah
- Very robust housing
- Impact resistant to 1 metre
- Lightweight and weatherproof
- Dimmable
- Battery charging indicator + low battery warning

	HIGH	LOW	DIMMABLE
LIGHT OUTPUT	3,500 LUMENS	1750 LUMENS	3,500 -100 LUMENS
Beam	30 METRES	15 METRES	0-30 METRES
RUN TIMES	4hrs	8hrs	24hrs
RECHARGEABLE LITHIUM BATTERY	IP54 RATING	CHARGING TIME 10HRS	DIMENSIONS 310mm x350mm X285mm
			1.52 KG

PRODUCT CODE: NSGALAXYPRO CAT/PAD: 0111/111966
 Supplied with: AC mains charger

OPTIONAL TRIPODS:



SPTRIPOD1.7 CAT/PAD: 0111/107803
 SPTRIPOD3.5M

Galaxy E-Pro

The Galaxy E-Pro is the same as the Galaxy Pro except it has a smaller 7.4V 6.6Ah battery and shorter run time.

	HIGH	LOW	DIMMABLE
LIGHT OUTPUT	3500 LUMENS	1750 LUMENS	3500 -100 LUMENS
RUN TIMES	2.5hrs	4.5hrs	12hrs
			1.24 KG

PRODUCT CODE: NSGALAXY-E-PRO

OPTIONAL ACCESSORIES:

NEW Optional tripod mount SPGALAXYTRIPODMOUNT



Quick Release Button

TWO MAGNETIC MOUNT OPTIONS:

NEW Central magnet SPGALAXYMAGMOUNT

OR

Set of 3 magnetic feet SPGALAXYPROMAG

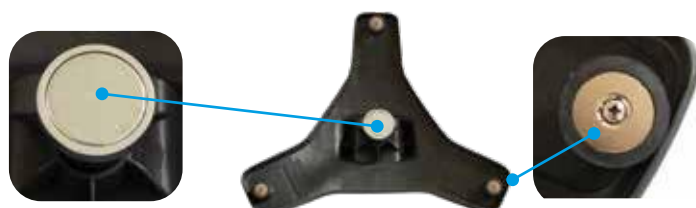

Designed to be used on steel beams, side of containers or small areas.

Designed to be used on a variety of larger metal surfaces.

OPTIONAL CHARGERS:

Vehicle Charger: CHIC8.4-LI-ION
 CAT/PAD: 0111/120648

AC Mains Charger: CH-GALAXYPRO-UK

NEW Galaxy-1200

NightSearcher

Rechargeable Robust Compact LED Work Light

The Galaxy 1200 is a compact rechargeable LED work light, with a powerful 1200 lumen light output. It has robust edge protection and is impact-resistant to 1 metre, easily withstanding knocks and bumps. Perfectly portable with a 180° folding carry handle/stand, with ultra powerful integrated magnets and a power bank that allows you to charge your mobile phone while you work.



KEY FEATURES:

- 1,200 Lumens - 50 metre beam
- Runs up to 7 hours
- Compact
- Impact resistant to 1 metre
- Rechargeable lithium battery - 3.7V 4400mAh
- Strong swivel stand, that rotates 180°
- USB rechargeable
- Magnetic carry handle
- Battery charging + status indicator
- Supplied with: USB charging cable



USB Power bank facility to charge your phone/tablet

	HIGH	LOW	FLASHING
LIGHT OUTPUT	1,200 LUMENS	600 LUMENS	1,200 LUMENS
Beam	50 METRES	25 METRES	50 METRES
RUN TIMES	3hrs	5hrs	7hrs
RECHARGEABLE BATTERY	CHARGING TIME 9HRS	IP54 RATING	DIMENSIONS 168mm x127mm x55mm
			491g

PRODUCT CODE: NSGALAXY1200

Optional accessories:



Optional tripod available: SPTRIPOD1.7



180° Degree foldable bracket/stand



Ultra powerful magnetic handle

Optional accessories:



EU Adaptor: CH-USB-EU



12/24V Vehicle Charger: CHIC3_7-LI-ION



AC Adaptor: CH-USB-UK

RECHARGEABLE LED WORK LIGHTS

NEW Galaxy Star

Powerful Robust Rechargeable LED Work Light

The Galaxy Star is a robust, portable, rechargeable work light made from extremely durable industrial strength aircraft grade aluminium and is impact-resistant to 1 metre. With a powerful 2800 lumen light output, choose from 5 output levels to ensure you have the brightness needed for any task. The work light weighs only 700g, which makes it the ideal portable work light, with a 180° foldable bracket/carry handle that helps position the light at an optimal angle.



3 YEAR WARRANTY



Battery/status Indicator
Heavy duty edge protection

KEY FEATURES:

- 2,800 Lumens - 90 metre beam
- Runs up to 11 hours
- Robust aluminium housing
- Lightweight
- Impact resistant to 1 metre
- Rechargeable lithium battery - 7.4V 2200mAh
- Strong swivel stand, that rotates 180°
- Battery charging + status indicator
- Supplied with AC charger



180° Degree foldable bracket/stand

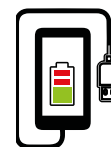

USB Power bank facility to charge your phone/tablet

	100%	70%	45%	35%	20%
LIGHT OUTPUT	2,800 LUMENS	2,000 LUMENS	1,500 LUMENS	1,000 LUMENS	500 LUMENS
Beam	90 METRES	72 METRES	54 METRES	36 METRES	18 METRES
RUN TIMES	1hrs 40 MINS	2hrs 15 MINS	5hrs 30 MINS	8hrs	11hrs
RECHARGEABLE LITHIUM BATTERY	CHARGING TIME 3.5HRS	IP54 RATING	700g	DIMENSIONS 170mm x170mm x48mm	

PRODUCT CODE: NSGALAXYSTAR

Optional accessories:



NEW



Galaxy Star Magnetic Mounting Bracket: SPGALAXYSTARMAG



Optional accessory 12/24V Vehicle Charger: CHIC3_7-LI-ION

Optional tripod available SPTRIPD1.7



NEW BeatLite 500

NightSearcher

Rechargeable LED Work Light with Bluetooth Connectivity and Speakers

The BeatLite 500 is a fully portable, rechargeable LED work light with Bluetooth connectivity and 5W Bluetooth speaker that allows you to listen to your favourite music while you work. The work light provides a bright 500 lumen light output, has a wide beam work light and a narrow beam torch light, and an energy saving Dimmable mode. The compact yet robust aluminium housing is ideal for workshops and work sites.



Wide LED beam

Narrow LED torch beam



Bluetooth
MUSIC WHILE YOU WORK



Bluetooth connection allows easy connection to smart phones, MP3 Players and tablets

KEY FEATURES:

- 500 Lumens - 50 metre beam
- Runs up to 10 hours
- Wide flood beam
- Narrow torch beam
- Bluetooth Connectivity
- Integrated 5W speakers
- Impact resistant to 1 metre
- Rechargeable lithium battery - 3.7V 3600mAh
- USB rechargeable
- Magnetic adjustable stand + hanging hook
- Battery charging + status indicator
- Supplied with: USB charging cable

	HIGH	LOW	TORCH
LIGHT OUTPUT	500 LUMENS	170 LUMENS	200 LUMENS
Beam	40 METRES	20 METRES	50 METRES
RUN TIMES	3hrs	10hrs	5hrs
RECHARGEABLE LITHIUM BATTERY	IP64 RATING	CHARGING TIME 4.5HRS	320g
DIMENSIONS 164mm x66mm x27mm			

PRODUCT CODE: NBEATLITE500



Magnetic stand/hanging hook



180° Degree rotating stand and hanging hook

Optional accessories:



EU Adaptor: CH-USB-EU



12/24V Vehicle Charger: CHIC3_7-LI-ION



AC Adaptor: CH-USB-UK

RECHARGEABLE LED WORK LIGHTS

NEW BeatLite 2000X

Rechargeable LED Work Light with Bluetooth Connectivity Speakers

The BeatLite 2000X is a versatile rechargeable LED work light with bluetooth connectivity and 2 x 20W integrated Bluetooth speaker and power bank. Allowing you to listen to your favourite music and charge your mobile devices on the go.



Wide LED beam



Bluetooth
MUSIC WHILE YOU WORK

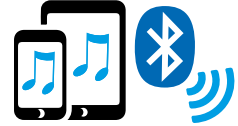

Bluetooth connection allows easy connection to smart phones, MP3 Players and tablets

KEY FEATURES:

- 2000 Lumens - 50 metre beam
- Runs up to 10 hours
- 5 light modes - 100%, 80%, 60% , 40%, 20%
- 2 x Integrated 20W speakers
- Impact resistant to 1 metre
- Rechargeable lithium battery - 7.4V 4000mAh
- 180° Degree foldable bracket/handle
- Robust aluminium housing
- Battery charging + status indicator
- Supplied with: AC Charger and 2 metre cable

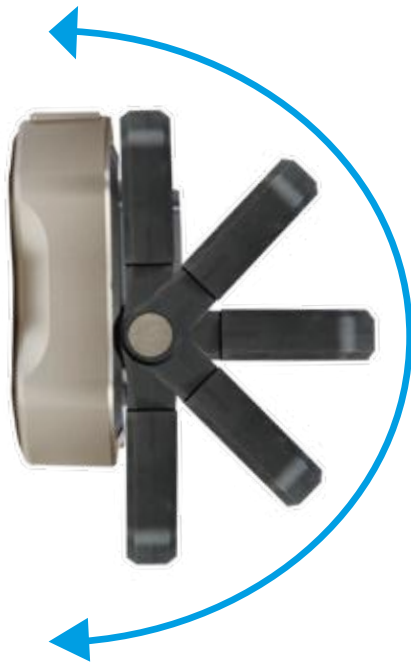

180° Degree Foldable Bracket/Handle

	100%	80%	60%	40%	20%
LIGHT OUTPUT	2,000 LUMENS	1,600 LUMENS	1,200 LUMENS	800 LUMENS	400 LUMENS
Beam	50 METRES	40 METRES	30 METRES	20 METRES	10 METRES
RUN TIMES	1hrs 30 MINS	2hrs	3hrs	4hrs 30 MINS	10hrs
RECHARGEABLE LITHIUM BATTERY	IPX4 RATING	CHARGING TIME 4HRS	1.15 KG	DIMENSIONS 210mm x137mm x64mm	

PRODUCT CODE: NBEATLITE2000X



USB Power bank facility to charge your phone/tablet

Optional accessories:



12/24V Vehicle Charger: CHIC3_7-LI-ION

Galaxy Mini-1000

Rechargeable Pocket-sized LED Work Light

The pocket-sized Galaxy Mini-1000 is a powerful work light. It has robust edge protection and is impact resistant, so can withstanding hard knocks in the workplace. The battery charging and status indicator button lets you know when it's time to recharge. The Galaxy Mini-1000 includes a built-in powerbank so you can charge your mobile phone whilst you work! A great little addition to any tool kit.



KEY FEATURES:

- 1,000 Lumens - 25 metre beam
- Runs up to 6.5 hours
- Compact size
- Impact resistant to 1 metre
- Rechargeable lithium battery - 3.7V 4400mAh
- Carry handle
- Battery charging + status indicator
- Supplied with: USB charging cable

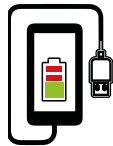

USB Power bank facility to charge your phone/tablet

	HIGH	LOW	SOS	FLASHING
LIGHT OUTPUT	1,000 LUMENS	500 LUMENS	1,000 LUMENS	1,000 LUMENS
Beam	25 METRES	12.5 METRES	25 METRES	25 METRES
RUN TIMES	3hrs	6.5hrs	3hrs	2.5hrs
RECHARGEABLE LITHIUM BATTERY	IP44 RATING	CHARGING TIME 6HRS	DIMENSIONS 170mm x42mm x12.7mm	455g

PRODUCT CODE: NSGALAXYMINI1000



180° Degree foldable bracket/handle

Optional tripod available SPTRIP0D1.7



Heavy duty edge protection

Optional accessories:



EU Adaptor: CH-USB-EU



12/24V Vehicle Charger: CHIC3_7-LI-ION



AC Adaptor: CH-USB-UK

Galaxy 1000 or 2000

Compact, Lightweight Rechargeable LED Work Light

The Galaxy 1000/2000 LED portable rechargeable work light is ideal for inspection and other tasks where a lightweight portable solution is required. It has a 360° movement thanks to the adjustable bracket and folds flat for easy storage. This powerful light is protected by the shatterproof polycarbonate lens and high impact ABS housing.

2 Models available:

KEY FEATURES:

- 1,000 or 2,000 Lumens
- 10 or 20 metre beam
- Runs up to 4 hours
- Rechargeable lithium battery
- Fold flat design for compact storage
- Lightweight compact design
- Carry handle/Floor standing
- Battery charging indicator
- High impact ABS housing and shatterproof polycarbonate lens
- Overcharge and discharge protection



360° Degree handle and stand

Galaxy 1000

Rechargeable lithium battery 7.4V 1800mAh

	HIGH	LOW		
LIGHT OUTPUT	1,000 LUMENS	500 LUMENS		
Beam	10 METRES	5 METRES		
RUN TIMES	1hrs 10MIN	3hrs 20MIN		
RECHARGEABLE BATTERY	IP54 RATING	CHARGING TIME 4HRS	DIMENSIONS 193mm x230mm x63mm	539g

PRODUCT CODE: NSGALAXY1000

Supplied with: USB Charging cable

Galaxy 2000

Rechargeable lithium battery 7.4V 4800mAh

	HIGH	LOW		
LIGHT OUTPUT	2,000 LUMENS	1,000 LUMENS		
Beam	20 METRES	10 METRES		
RUN TIMES	2hrs	4hrs		
RECHARGEABLE BATTERY	IP54 RATING	CHARGING TIME 8HRS	DIMENSIONS 193mm x230mm x63mm	911g

PRODUCT CODE: NSGALAXY2000

Supplied with: 230V AC + Vehicle Charger

Optional accessories:



Optional tripod available SPTRIP0D1.7



EU Adaptor: CH-USB-EU



12/24V Vehicle Charger: CHIC3_7-LI-ION



AC Adaptor: CH-USB-UK

See the Galaxy 1000/2000 video



[Video link](#)

Galaxy 1500R

Rechargeable LED Work Lights With Folding Case For Impact Protection

The Galaxy 1500R is a versatile lightweight portable work light, that has been designed for use on work sites where a power source is not readily available. The light has a robust housing to protect the lights when being transported or stored. The Galaxy 1500R easily folds out to a floor standing A-frame, giving multi-directional light.



Protective folding case design

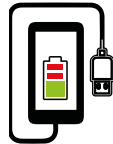

USB Power bank facility to charge your phone/tablet

KEY FEATURES:

- 1,500 Lumens - 15 metre beam
- Runs up to 3 hours
- Rechargeable lithium battery - 7.4V 4400mAh
- Robust housing
- Anti-glare diffused lens for wide spread shadow free light
- Battery charging + status indicator
- Built in heat sink
- Supplied with: USB charging cable

	HIGH	LOW	
LIGHT OUTPUT	1,500 LUMENS	750 LUMENS	
Beam	15 METRES	7.5 METRES	
RUN TIMES	1hrs 30MIN	3hrs	1.22 KG
RECHARGEABLE LITHIUM BATTERY	IP54 RATING	CHARGING TIME 3.5HRS	DIMENSIONS 180mm x115mm x270mm

PRODUCT CODE: NSGALAXY1500R

Three light modes:

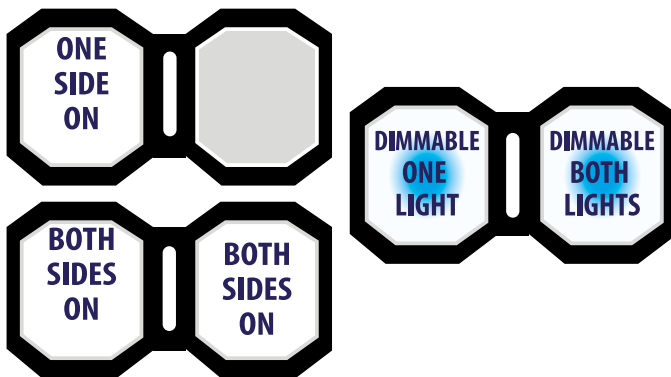

Floor standing 'A frame'



Optional tripod available SPTRIPOD3.5M

Optional accessories:



EU Adaptor: CH-USB-EU



12/24V Vehicle Charger: CHIC3_7-LI-ION



AC Adaptor: CH-USB-UK

Galaxy Dual

Dual Powered AC Mains + Rechargeable Led Work Light

The Galaxy Dual work light can be powered via AC mains or from its rechargeable Lithium battery. Making this product very versatile, where mains power is not always available.



KEY FEATURES:

- 2,000 Lumens - 20 metre beam
- Runs up to 8 hours
- Rechargeable lithium battery - 3.7V 4400mAh
- Nylon stand and handle
- Rubberised moulded edge to prevent scratches
- Tough, die cast aluminium housing
- Impact Resistant to 1.5 metre
- Supplied with an AC adaptor and 5 metre cable

	HIGH	LOW		
LIGHT OUTPUT	2,000 LUMENS	800 LUMENS		
Beam	20 METRES	10 METRES		
RUN TIMES	2hrs	8hrs	1.3 KG	
RECHARGEABLE LITHIUM BATTERY	110 OR 240V AC	IP65 RATING	CHARGING TIME 4HRS	DIMENSIONS 220mm x225mm x70mm

PRODUCT CODE: NSGALAXYDUAL

3 YEAR WARRANTY

DUAL POWER

OR

**AC MAINS
110V OR 240V**

RECHARGEABLE



Optional tripod available
SPTRIPOD3.5M



Optional accessories:



Galaxy Dual Tripod Mounting Plate:
SPGALAXY-DUALPLATE



Galaxy Dual Magnetic Mounting Bracket:
SPGALAXY-DUALMAG

NEW Galaxy AC 3200 + 6000

AC LED Work Lights - Folding Case For Extreme Heavy Duty Protection

The Galaxy work light range, allows you to connect with other lights and power tools. The light has a robust housing to protect the dual LED lights when being transported or stored. The Galaxy work light easily folds out to a floor standing A-frame, giving multi-directional light and can be tripod mounted.



1 x 240V sockets outlets , 13Amp, BS plug
Connect tools or link lights together

KEY FEATURES:

- 3200 Lumens - 1,600 Lumens per light head
- Protective folding case design
- Anti-glare diffused lens for wide spread shadow free light
- Linkable lights
- Cool operation - no hot surfaces
- Carry handle - for easy transportation
- Ideal for painting/decorating
- Foldable and lockable light
- Built in heat sink
- Robust rubberised housing
- Supplied with heavy duty, 2 metre HO7RN-F cable

	HIGH	LOW	
LIGHT OUTPUT	3200 LUMENS	1600 LUMENS	
Beam	25 METRES	15 METRES	
IP54 RATING	LINKABLE LIGHTS	1.60 KG	DIMENSIONS 280mm x185mm x190mm

PRODUCT CODE: NSGALAXYAC3200

Galaxy 6000-110



2 x 110V CEE sockets outlets, 16Amp, 110V plug
Connect tools or link lights together

KEY FEATURES:

- 6000 Lumen - 3,000 Lumens per light head
- Protective folding case design
- Anti-glare diffused lens for wide spread shadow free light
- Linkable lights
- Cool operation - no hot surfaces
- Carry handle - for easy transportation
- Ideal for painting/decorating
- Foldable and lockable light
- Built in heat sink
- Robust rubberised housing
- Supplied with heavy duty, 2 metre HO7RN-F cable

	HIGH	LOW	
LIGHT OUTPUT	6000 LUMENS	3000 LUMENS	
Beam	45 METRES	24 METRES	
IP54 RATING	LINKABLE LIGHTS	3.2 KG	DIMENSIONS 220mm x175mm x330mm

PRODUCT CODE: NSGALAXYAC6000-110V
CAT/PAD: 0111/114227

NEW Galaxy AC 3200 + 6000

Two light modes:

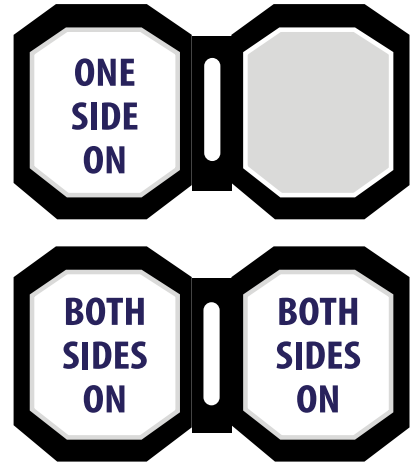

Protective folding case design



Optional tripod available
SPTRIPOD3.5M



Floor standing
'A frame'



Fast Star Range Outdoor LED Floodlights



DESIGNED FOR FAST + SIMPLE INSTALLATION

Designed for quick and simple installation

2 ways to connect to mains AC supply:

Directly into internal terminal block

Or

With cable provided into a suitable rated junction box.

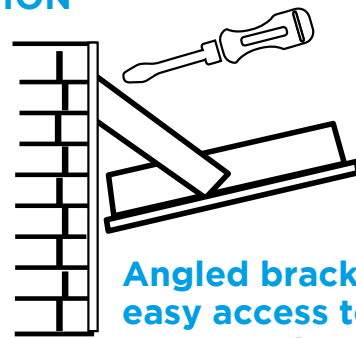

Angled bracket gives easy access to secure onto wall

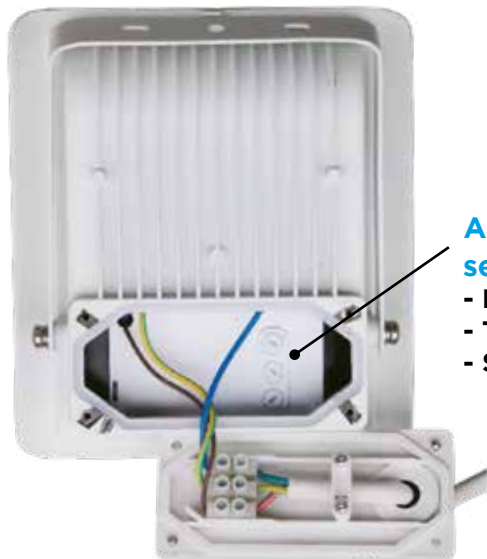

Adjustable settings:

- Lux
- Time
- Sens



Up To 90% More Efficient Than Traditional Lighting

Perfect for around the home, providing light to driveways and adding security.

Fast Star Range Outdoor LED Floodlights

Slim Design LED Security Light

The FastStar range has been designed for fast and easy installation. It can be connected into its own internal terminal block or alternatively it comes with a pre-wired 30cm cable to connect into a suitable external junction box. It also has a clever angled wall bracket which allows easy fixing without the need to remove the bracket.



3 Models available: 10W, 30W, 50W



With PIR sensor
3 Models available:
10W, 30W, 50W

KEY FEATURES:

- IP65 Rating
- Aluminium housing
- Tough glass lens
- Slimline compact design
- 6000K cool white colour temperature
- PIR models lights
- Supplied with 30cm cable
- Adjustable settings:
Lux, Time and Sens



10W	800 LUMENS	10 METRES	DIMENSIONS 113.4mm x127.9mm x52mm	334g
30W	2400 LUMENS	20 METRES	DIMENSIONS 147.6mm x166.3mm x56.3mm	555g
50W	4000 LUMENS	30 METRES	DIMENSIONS 166.8mm x188mm x56.3mm	730g



PRODUCT CODE: NSFASTSTAR10/30/50
PRODUCT CODE: NSFASTSTAR10/30/50PIR



LED Festoon Lights

22 Metres, Fully Encapsulated Festoon Kit - 10 x 660 Lumens

The Festoon LED work lights are ideal AC work lights for industrial and construction applications. The 110V LED Festoon lighting is energy efficient, saving up to 80% electrical power making them a cost effective lighting solution for indoor and outdoor use. Highly robust polycarbonate Lenses and body, handy loops for fixing with cable ties.



Also available in 50 Metres



10 x LED lamps

22 Metre 2 x 0.75mm yellow arctic grade cable with 16A 110V CEE Plug



KEY FEATURES:

- 10 x 660 lumens
- 22 Metre x 10 LED lights
- Lamp holders spaced every 2 metres
- IP65 Rating - Sonic Sealed
- Low heat output - Saves 80% electrical power
- 30,000 hours life
- Fitted with 16A 110V CEE Plug



PRODUCT CODE: NSFESTOON22M8W



Optional accessories:
14 Metre extension lead available (110v Only):
SPCABLE14M



NEW Lunar Star



110V, 50W LED Highly robust self contained Led Work light

The Lunar Star 110V LED work light is ideal for industrial and construction applications. It is fitted with two 110V 16A IP44 socket outlets to BS/EN60309-2 for connection of power tools rated up to 1500W or linking up to 25 Lunar Stars together. The Lunar Star can be used as a floor light hung by the hanging hook or mounted on a tripod. A switch mounted on the side allows easy operation and when the work is done the built in cable storage allows the Lunar Star to be stored neatly.

KEY FEATURES:

- 110V AC
- 4,000 lumens light output
- Ultra bright LEDs
- 360° spread of light
- 2 x Socket CEE outlets:
 - For using power tools rated up to 1500W
 - Or linking up to 25 Lunar Stars together
- Robust high impact polycarbonate housing
- Carry handle - for easy transportation
- Supplied with 5 metre H05VV-F cable
- Built in cable storage



 4,000 LUMENS 50W	 2.5 KG		
110V AC 50/60Hz	IP44 RATING	LINKABLE LIGHTS	DIMENSIONS 250mm x125mm x120mm

PRODUCT CODE: NSLUNARSTAR50



Link lights together

3 YEAR WARRANTY



Optional tripod available:
SPTRIPOD3.5m



2 X Socket Outlets:
Connect tools or link lights together

Hanging hook



Gripper Light

Gripper Inspection Lamp, 110V CEE or 240V AC BS Plug, 60W

This heavy duty inspection lamp features a 50mm wide clamp with hand grips and a useful hanging hook for hand free working. Ideal for clamping to joists, scaffolding or under car bonnets etc.



240V AC BS plug
or 110V CEE plug

KEY FEATURES:

- 240V AC BS plug or 110V CEE plug
- Spring loaded handles for hands-free work
- Tough composite construction
- Bulb mounted in a ceramic holder and protected by a metal grille
- Double insulation construction
- E27 Lamp holder
- Supplied with heavy duty, HO5RN-F cable 1.5 metre

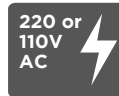

PRODUCT CODE: NSGRIPPER110V
PRODUCT CODE: NSGRIPPER240V



Bulb not included



Tower Pro

Lightweight, Portable LED Lighting Tower

The Tower Pro is an easy to deploy tripod mounted area/scene light. It provides 360° of light from its six foldable and lockable light heads which have anti-glare diffused lenses providing wide spread, shadow free light, with a daylight colour temperature of 6500K. It can be powered from a 230V or 110V supply, it is supplied with 10M of rubber sheathed abrasion resistant cable. The robust aluminium tripod extends the light head to 3.5 metres and is extremely stable. One person can easily carry and deploy the system in under one minutes.

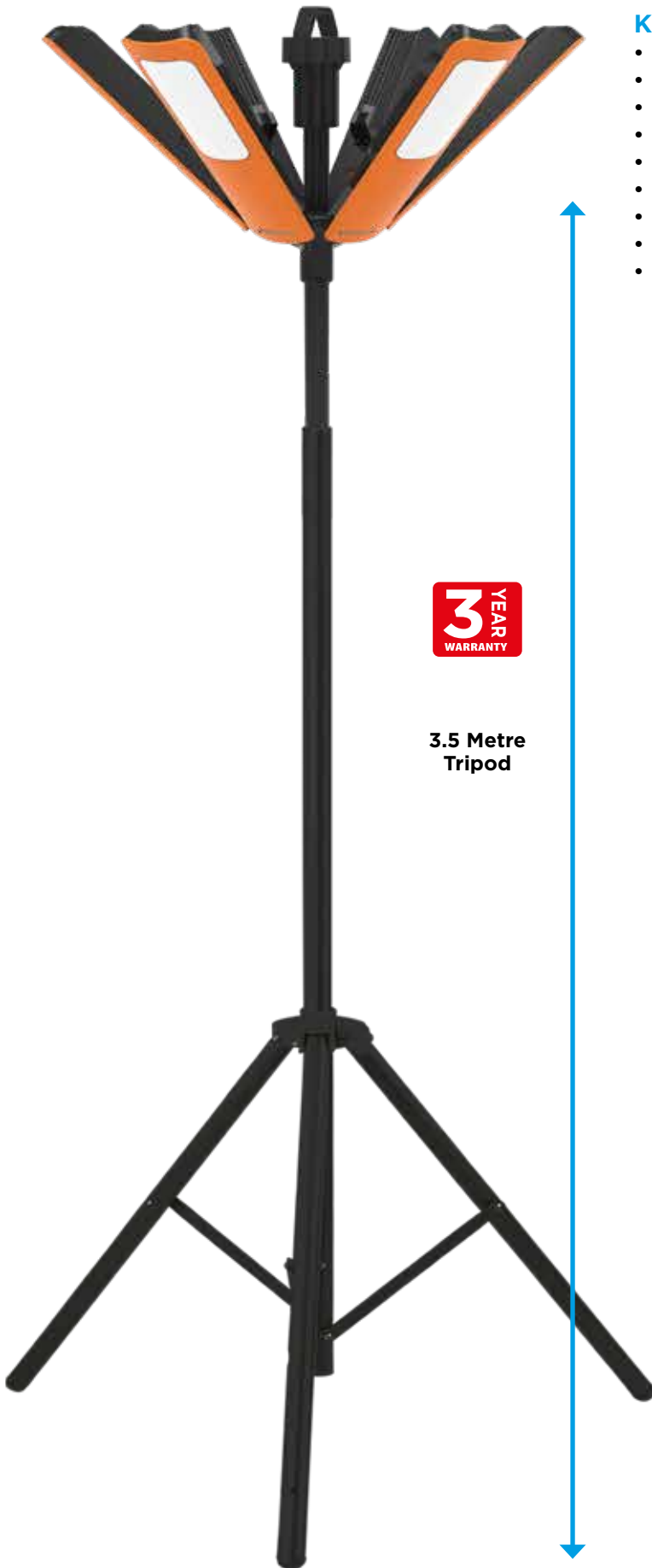

3 YEAR WARRANTY

3.5 Metre Tripod

KEY FEATURES:

- 16,000 Lumens
- 50 metre beam
- 360° fold out light
- Anti-glare diffused lens for wide spread
- Foldable and lockable light heads
- 6500K cool white colour temperature
- Robust housing absorbs knocks on site
- Extends up to 3.5 metres
- Supplied with 10 metres of H07RN-F cable - 3.5 Metre tripod



16000 LUMENS



50 METRES

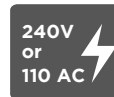

PRODUCT CODE: NSTOWERPRO



Collapsed size:
30x30x49cm







Optional accessory:
Carry bag for light head

EcoStar Pro (Non Linkable)

Industrial LED Floodlights

ECOSTAR Pro floodlights are powered by SMD LEDs with lower energy consumption compared to halogen and discharge lighting, providing excellent performance and a notably shadow free illumination.



 LIGHT OUTPUT	50W 4000 LUMENS (50W)		
 Beam	8 METRES		
 85-265V AC	 IP65 RATING	 DIMENSIONS 300mm x245mm x60mm	 3.10 KG

PRODUCT CODE: NSESPRO50



Slim design

KEY FEATURES:

- High powered SMD LED
- Robust aluminium casing
- Beam angle: 120°
- Adjustable bracket
- IP65 Weather proof rating (Light head)
- Can operate on power sources between 85V-265V AC 50-60Hz
- Low heat emission = with no cool down required before storage
- Light small or large areas
- 0.5 Metre cable
- High performance heat sink



EcoStar Pro Linkable

Industrial Linkable LED Floodlights

The ECOSTAR Pro 110V linkable is the lighting solution for the industrial, construction market and outdoor events. The extraordinary efficiency and performance over when compared to halogen and discharge lighting, this means huge savings in running costs. Fitted with CEE 110V plug and socket allowing multiple lights to be linked together. Linkable versions enable convenient 'daisy chaining'.



50W		100W	
LIGHT OUTPUT	400 LUMENS (50W)	8000 LUMENS (100W)	
Beam	8 METRES	10 METRES	
85-265V AC	IP65 RATING	DIMENSIONS 240mm x200mm x50mm	1.75 KG

PRODUCT CODE: NSESPROLINK50
 CAT/PAD: 0111/107623
 NSESPROLINK100



Slim design

Optional accessories:

Tripods:



STEEL TRIPOD
Max. (H) 1.7m:
SPTRIPOD1.7

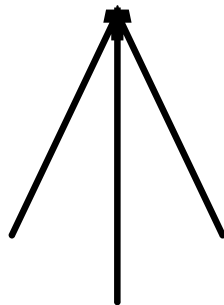

SWING LEGGED TRIPOD
Max. (H) 2.2m:
SPTRIPODSL

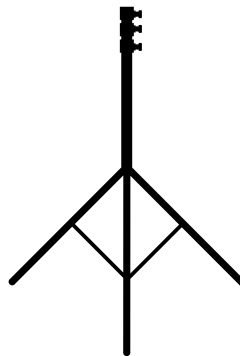

3.5M TRIPOD
Max. (H) 3.5m:
SPTRIPOD3.5M



14 Metre extension lead:
(110v Only):
SPCABLE14M

Tripods with T-Bar:



STEEL TRIPOD T-BAR
Max. (H) 1.7m:
SPECOSTARTBAR

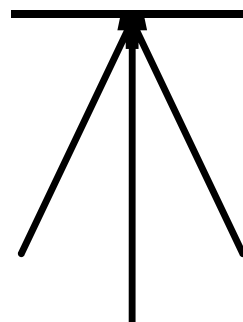

SWING LEGGED TRIPOD T-BAR
Max. (H) 2.2m:
SPECOSTARTBAR

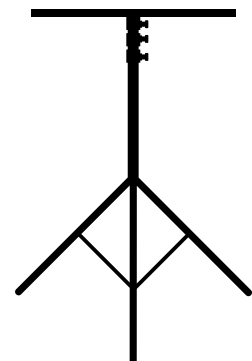

3.5m TRIPOD T-BAR
Max. (H) 3.5m:
SPECOSTARTBAR

NEW HawkStar & HawkStar-X



Isle Of Wright Needles NCI
- National Coast Watch



Forensic Collision Investigation Unit

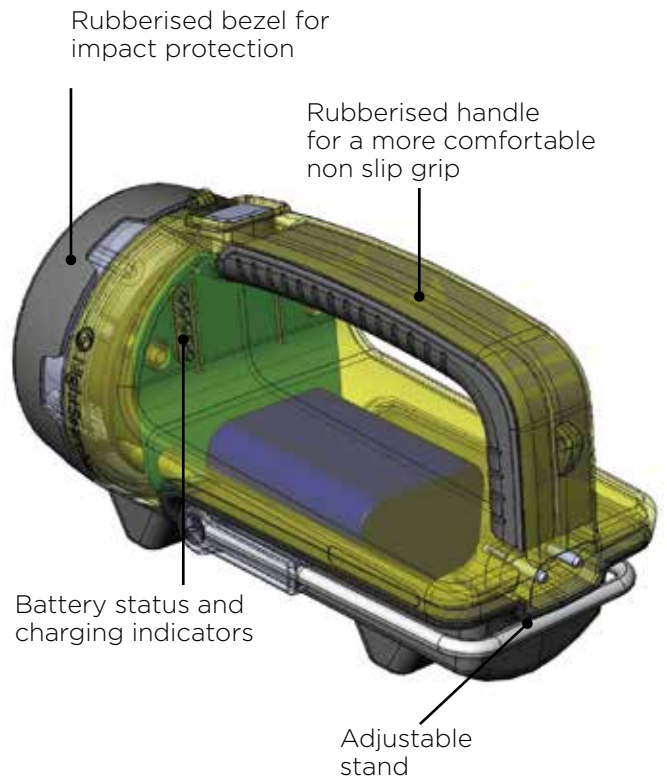
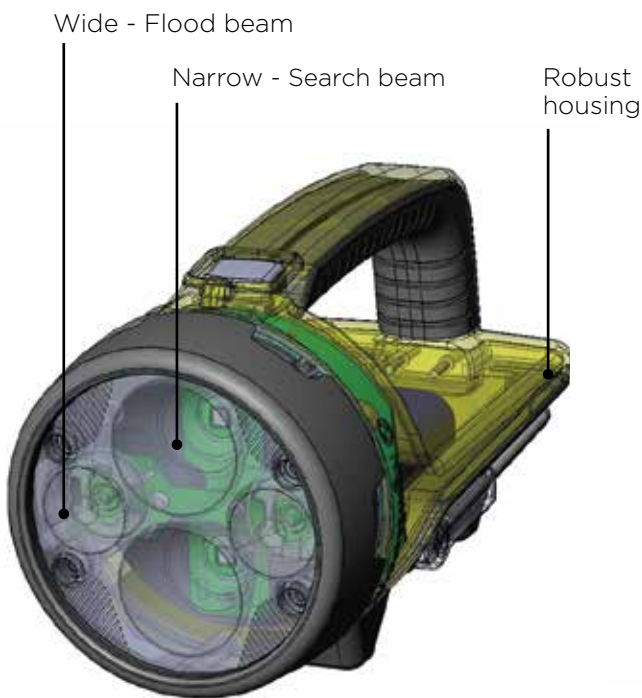

HAWKSTAR

	BOOST	SEARCH	FLOOD
LIGHT OUTPUT	2,500 LUMENS	1,250 LUMENS	1,000 LUMENS
Beam	400 METRES		
	3hrs 30min	7hrs	6hrs 30min
RECHARGEABLE LITHIUM BATTERY	CHARGING TIME 6.5HRS	IP67 RATING	DIMENSIONS 250mm x125mm x120mm
			1kg

PRODUCT CODE: NSHAWKSTAR
Supplied with: Charging Bracket and Vehicle Charger

HAWKSTAR-X

	BOOST	SEARCH	FLOOD
LIGHT OUTPUT	4,200 LUMENS	2,200 LUMENS	2,000 LUMENS
Beam	600 METRES		
	4hrs 30min	7hrs 15min	7hrs 30min
RECHARGEABLE LITHIUM BATTERY	CHARGING TIME 6.5HRS	IP67 RATING	DIMENSIONS 250mm x125mm x120mm
			1.1kg

PRODUCT CODE: NSHAWKSTAR-X

Optional accessories:



NEW HawkStar & HawkStar-X

Professional Rechargeable LED Searchlight, 4200 lumens

The HawkStar range of searchlights have been designed and engineered by NightSearcher to satisfy the high standard required by emergency services, search & rescue teams and industrial sectors. Utilising high lumen output LEDs, specially designed reflectors and optics, both models offer wide and narrow light beams, making them ideal for long distance searching or flood lighting wider areas. The HawkStar has been designed to survive a 70 mph crash, as tested by the Institute of Traffic Accident Investigators.

NightSearcher

3 Beams:
Narrow, Wide or Boost

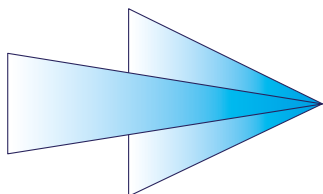

Wall & vehicle mountable charging bracket with quick release lever.

See the HawkStar video



[Video link](#)



Adjustable Stand



3 YEAR WARRANTY

KEY FEATURES:

- Designed to be used in Emergency Service Vehicles
- Light power 4,200/2,500 lumens
- Wide angle Flood or Narrow angle Search beam
- Multiple brightness levels and Dimmable
- 7.4V 6.6/10.2Ah Li-ion maintenance free battery
- 9 Light modes with up to 30 hours operation
- Max beam distance 600 metres
- Battery status and charging indicator
- Fits securely in charging bracket - Crash tested at 70MPH (112KPH)
- Quick release from bracket for fast and easy deployment
- Rubberised handle for comfortable non slip grip
- One hand operation
- Comfortable shoulder strap
- 6 Hours charging time
- Robust housing
- Anti slip rubberised base with built in stability

DESIGNED TO SURVIVE A 70 MPH CRASH AS TESTED BY THE INSTITUTE OF TRAFFIC ACCIDENT INVESTIGATORS

The searchlight and cradle assembly has been designed and tested to withstand a car crash. It passed tests undamaged and worked perfectly when crash tested at 70mph by the Institute of Traffic Accident Investigators.



RECHARGEABLE SEARCHLIGHTS

ProStar & **NEW** ProStar Lite

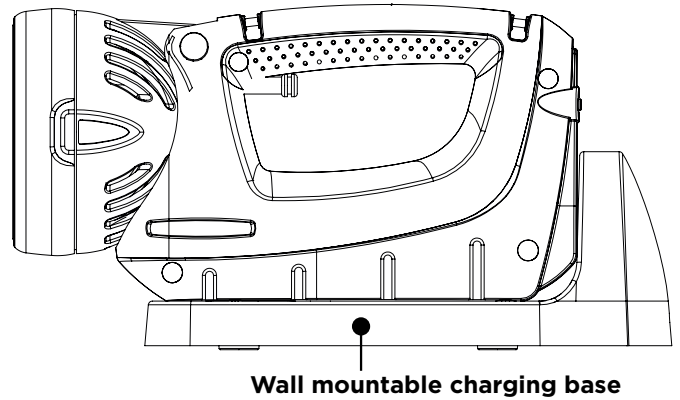
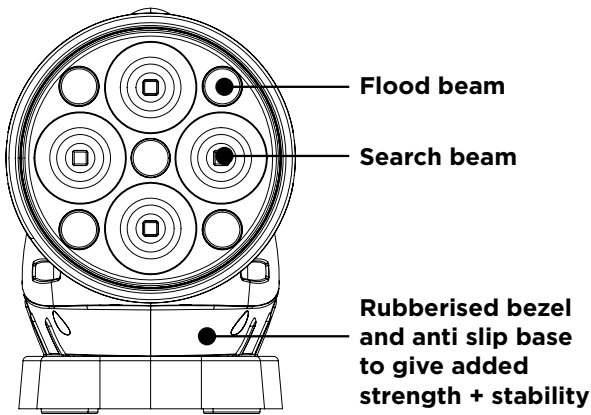

Now Available In 2 Battery Sizes:

PROSTAR LITE 7.8AH OR PROSTAR - 14.8V 10.2AH BATTERY

The ProStar Lite has the same performance as the ProStar except it has a smaller 7.8Ah battery and shorter run times.

	BOOST 10,000 LUMENS	SEARCH 7,400 LUMENS	FLOOD 7,000 LUMENS
	1,200 METRES		
RECHARGEABLE LITHIUM BATTERY	CHARGING TIME 6 HRS	IP65 RATING	DIMENSIONS 280mm x160mm x120mm

NEW Optional extra:



Folding solar panel charger
Go to Page 102 for more information
PRODUCT CODE: SPSOLARPANEL

Mode		Lumens	ProStar Lite Runtimes	ProStar Runtimes
Boost	Search + Flood Full	10,000	1 hour	1 hour 30 minutes
Search	Full	7,400	1 hour 30 minutes	2 hours
	Half	3,700	3 hours	4 hour 15 minutes
	Low	1,850	6 hour 15 minutes	10 hours
Flood	Full	8,800	2 hours	2 hour 20 minutes
	Half	4,400	3 hour 30 minutes	4 hour 45 minutes
Dimmable	Full	8,800	2 hour 30 minutes	3 hour 30 minutes
	Low	1,000	18 hours	25 hours
Weight			1.5kg	1.8kg
Product Code			NSPROSTAR-LITE	NSPROSTAR

ProStar & **NEW** ProStar Lite

Professional Rechargeable LED Searchlight, 10,000 Lumens

The ProStar has been very thoughtfully designed for emergency situations and is ideal for both Search and rescue and scenes of crime operations. With its dual optics and reflective system it is perfect for long distance searching and for wide area floodlighting and now with its newly improved power it delivers an amazing 10,000 lumens of light.



PROSTAR LITE:
Now available with a light weight battery.

See the ProStar video



[Video Link](#)



Long distance spot beam

Wide angled flood beam



Adjustable swivel head

KEY FEATURES:

- Light power up to 10,000 lumens
- Long distance spot beam
- Wide angled flood beam
- Li-ion maintenance free battery
- 9 Light modes with up to 10 hours operation
- Swivel head for multiple head angle position
- Battery status and charging indicator
- Wall mountable charging base
- Rubberised handle for comfortable non slip grip
- Rubberised light front and base to give added strength and stability
- One handed operation
- Comfortable shoulder strap
- 6 Hours charging time
- Robust housing
- Anti slip rubberised base with built in stability



Wall mountable charging base

Supplied with: AC adaptor, charging base and shoulder strap

Puma XML

NightSearcher

Small, Compact Rechargeable LED Searchlight, 800 Lumens

The rechargeable PUMA is a lightweight and compact alternative of the PANTHER, used for professional applications by Emergency Services and Utility Companies. Used in all weather conditions, the Puma is virtually unbreakable, incorporating a toughened glass lens and a shock resistant polyethylene plastic case.



KEY FEATURES:

- 800 Lumens
- 400 metre beam
- Runs up to 7 hours
- Lightweight design
- Rechargeable lithium battery - 3.7V 4.4Ah
- 2 Position adjustable handle
- Powerful CREE XML LEDs
- Unique deep dish reflector
- Robust polyethylene construction
- Virtually unbreakable casing
- Attachable wrist strap
- Battery charging indicator
- Supplied with AC mains charger, shoulder carrying strap



Wide Light Beam
Ideal For Emergency Services,
Utility Company Applications

	HIGH	LOW
LIGHT OUTPUT	800 LUMENS	400 LUMENS
Beam	800 METRES	400 METRES
RUN TIMES	3hrs	7hrs
RECHARGEABLE LITHIUM BATTERY	IP54 RATING	CHARGING TIME 10HRS
	DIMENSIONS 210mm x120mm x140mm	500 G

PRODUCT CODE: NSPUMAXML
CAT/PAD: URLT/010412

Optional accessories:



Vehicle charging bracket:
CHICPUMAXMLBASE



Vehicle/wall mounting bracket:
SPPUMABRACKET



Vehicle charger:
CHIC3.7-LI-ION



110 mm Diffused lens:
SPLENS110-DIF

See the Puma XML video



[Video Link](#)



RECHARGEABLE SEARCHLIGHTS

Panther XHP-X









Professional Rechargeable LED Searchlight, 1,800 Lumens

The PANTHER XHP-X has now upgraded to the latest LED technology increasing the running time to 3hrs on full and 8hrs on half power. The unique deep dish reflector enables maximum distance to lumen ratio achieving a 1000m beam from only 1,800 lumens; weighing under 1kg it is our lightest in the range and offers exceptional value for money.



KEY FEATURES:

- 1,800 Lumens
- 1000 metre beam
- Runs up to 8 hours
- Lightweight design
- Rechargeable lithium battery - 7.4V 4.4Ah
- Robust polyethylene construction
- Virtually unbreakable casing
- Unique deep dish reflector
- Battery charging indicator
- Supplied with: AC charger & adjustable stand

	HIGH	LOW		
 LIGHT OUTPUT	1,800 LUMENS	750 LUMENS	 Beam	1,000 METRES
 RUN TIMES	3hrs	8hrs	 RECHARGEABLE LITHIUM BATTERY	 CHARGING TIME 9 HRS
 IP54 RATING	 DIMENSIONS 260mm x150mm x180mm	 1 KG		

PRODUCT CODE: NSPANTHERXHP-X
CAT/PAD: 0111/108311

Optional accessories:



Vehicle/wall mounting bracket:
SPPANBRACKET

Vehicle charger:
CHIC8.4-LI-ION

Vehicle charging bracket:
CHICPANTHERXHPCHBRACKET

NEW Optional extra:



Folding solar panel charger
Go to Page 102 for more information
product code: SPSOLARPANEL



Trio-550

 NightSearcher

RECHARGEABLE SEARCHLIGHTS



Trio-550

Rechargeable LED Searchlight, 550 Lumens

The TRIO-550 has a long range beam of up to 500m, and ideal for patrolling, security guards, search & rescue, robust construction it's durable enough for all applications. The TRIO 550 features an emergency function to automatically illuminate in the event of a power cut. It can be mounted on walls or in vehicles using the bracket supplied.



USB Power bank facility to charge your phone/tablet



2 Models available:
Hi Viz Yellow or Grey and Blue



See the Trio-550 video



[Video Link](#)

Emergency function to automatically illuminate in the event of a power cut

KEY FEATURES:

- 550 Lumens
- 600 metre beam
- Runs up to 15 hours
- Lightweight design
- Rechargeable lithium battery - 3.7V 16.65W 4500mAh
- USB output - Can charge phone
- Tough durable construction, Polycarbonate lens
- 3 x CREE LEDs XP-G2 cool white
- Water and shock resistant
- Can be mounted on walls or in vehicle
- Supplied with Wall mount, USB cable, USB 12V-24V car charger, shoulder strap, AC USB mains adaptor



	HIGH	LOW	FLASHING	
LIGHT OUTPUT	550 LUMENS	275 LUMENS	550 LUMENS	
Beam	600 METRES	300 METRES	600 METRES	
RUN TIMES	3hrs	7hrs	15hrs	
RECHARGEABLE LITHIUM BATTERY	IP54 RATING	CHARGING TIME 10HRS	DIMENSIONS 193mm x117mm x132mm	650 g

PRODUCT CODE:
NSTRIO550Y (YELLOW+GREY)
NSTRIO550 (GREY+BLUE)

SoloStar

NightSearcher

RECHARGEABLE SEARCHLIGHTS

Rechargeable LED Searchlight, 450 Lumens

This SoloStar is an ultra lightweight searchlight, and is highly visible in its surroundings due to the green robust polypropylene plastic housing. Ideal for most outdoor adventures such as camping, hiking, walking the dog as well as professional use in horticultural and construction sectors. Includes a built-in powerbank, so can easily charge your mobile phone or tablet on the go!



KEY FEATURES:

- 450 Lumens
- 500 metre beam
- Runs up to 12 hours
- Lightweight design
- Rechargeable lithium battery - 3.7V 4000mAh
- Powerbank - Can charge your phone
- Powerful CREE XP-G LEDs
- High visibility colour
- Robust polypropylene plastic housing
- Battery charging indicator

See the SoloStar video



[Video Link](#)



	HIGH	LOW		
LIGHT OUTPUT	450 LUMENS	150 LUMENS		
Beam	500 METRES	250 METRES		
RUN TIMES	4hrs	12hrs		
RECHARGEABLE LITHIUM BATTERY	IP44 RATING	CHARGING TIME 12HRS	DIMENSIONS 209mmx 133mm 125mm	400 g

PRODUCT CODE: NSOLOSTAR

Supplied with AC & vehicle charger

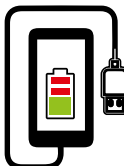

USB Power bank facility to charge your phone/tablet



Counter top display

Trigger Pro

Rechargeable LED Searchlight, 1,000 Lumens

The Trigger Pro is the first lightweight LED alternative to 2-3 million candle power halogen searchlights, which are very inefficient. The unique deep dish reflector system combined with high intensity CREE LED provides a spot beam that is able to cover up to a 1000 metres.



3 YEAR WARRANTY









KEY FEATURES:

- 1,000 Lumens
- 700 metre beam
- Runs up to 15 hours
- Lightweight design
- Rechargeable lithium battery (3.7V 3600mAh)
- Powerful CREE XPL LED
- Unique deep dish reflector
- Rubberised handle for comfortable grip
- Robust polycarbonate construction
- Virtually unbreakable casing
- Micro USB charging port
- Battery status and charging indicator
- One hand trigger operation
- Supplied with wrist strap, micro USB cable, 12V vehicle charger, USB mains adaptor



Battery status and charging indicator



	HIGH	LOW	STROBE
 LIGHT OUTPUT	1,000 LUMENS	100 LUMENS	1,000 LUMENS
 Beam	700 METRES	200 METRES	
 RUN TIMES	3hrs 40MINS	15hrs	
 RECHARGEABLE LITHIUM BATTERY	 IPX4 RATING	 CHARGING TIME 5HRS	 DIMENSIONS 293mm x 90mm Diameter
			 700 g

PRODUCT CODE: NSTRIGGER-PRO
CAT/PAD: 0111/113529

Optional accessories:



AC Adaptor:
CH-USB-UK



NEW SL1600 + SL900 + SL200

Professional Rechargeable Led Searchlights With Adjustable Handle + Stand

An updated version of NightSearcher's SL360, the SL900 rechargeable LED searchlight has an adjustable handle that can be operated in three positions, including a comfortable pistol grip. The Cree LED provides a massive 900 lumen light output and 500m beam perfect for professional applications. The SL900 has a robust construction that's impact proof, and the deep-dish reflector enables maximum distance-to-lumen ratio for a bright spot beam.

SL900



Adjustable stand

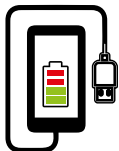

USB Power bank facility to charge your phone/tablet

KEY FEATURES:

- 900 Lumens
- Runs up to 5 hours
- Powerful CREE XM-L LEDs
- Lightweight design
- 500 metres beam distance
- Two position handle
- Rechargeable lithium battery - 3.7V 2400mAh
- Powerbank - Can charge your phone
- Storage for charging cable
- Robust polypropylene plastic housing
- Battery status indicator
- Supplied with AC & vehicle charger

	HIGH	LOW	FLASHING
LIGHT OUTPUT	900 LUMENS	280 LUMENS	280 LUMENS
Beam	500 METRES	260 METRES	500 METRES
RUN TIMES	1hrs 30 MINS	4hrs	5hrs
RECHARGEABLE BATTERY	IP44 RATING	CHARGING TIME 7HRS	DIMENSIONS 123mmx 158mm 170mm
			530 g

PRODUCT CODE: NSSL900



Pistol handle position



Adjustable handle

NEW SL1600 + SL900 + SL200

Professional Rechargeable Led Searchlights With Adjustable Handle + Stand

The SL1600 LED searchlight features an amber flashlight for emergency or signalling purposes. The robust casing is drop, shock and water resistant and includes an integrated adjustable stand and swivel handle (adjustable through 90°) allowing a pistol grip for searchlight applications or a carry handle.

SL1600



KEY FEATURES:

- 1,600 Lumens
- 1000 metre beam
- Runs up to 120 hours
- Lightweight design
- Rechargeable lithium battery (7.4V 4400mAh)
- 3 Position adjustable handle
- Deep dish reflector
- Ultra bright XHP50 LEDs
- Supplied with AC & vehicle chargers

	HIGH	AMBER FLASHING
LIGHT OUTPUT	1600 LUMENS	14 LUMENS
Beam	1000 METRES	100 METRES
RUN TIMES	3hrs	120hrs
RECHARGEABLE LITHIUM BATTERY	IP44 RATING	CHARGING TIME 6HRS
	DIMENSIONS 226x165 179mm Diameter	1.03 KG

PRODUCT CODE: NSSL1600

NEW SL200

Rechargeable LED Searchlight

The SL200 is a compact, ultra-lightweight rechargeable LED searchlight, perfect for the home or as an emergency light source in the car. Made from durable polypropylene, the SL200 is impact resistant to 1 metre, and has a sturdy handle that provides a good grip. The SL200 weighs just 230g making it one of our smallest searchlights available, but packs a big punch with a bright 250-metre beam.



KEY FEATURES:

- 200 Lumens
- Runs up to 7 hours
- Lightweight design
- 250 metres beam distance
- Rechargeable lithium battery - 3.7V 1200mAh
- Unique deep dish reflector
- Robust polypropylene plastic housing
- Battery status indicator
- Supplied with AC & vehicle charger

	HIGH	LOW
LIGHT OUTPUT	200 LUMENS	80 LUMENS
Beam	250 METRES	100 METRES
RUN TIMES	2hrs	7hrs
RECHARGEABLE LITHIUM BATTERY	CHARGING TIME 4HRS	DIMENSIONS 160mmx 102mm 122mm
		230 g

PRODUCT CODE: NSSL200

300mm
250mm
200mm
150mm
100mm
50mm



KEYSTAR
300 Lumens
110m Beam

EXPLORER-XSR
400 Lumens
100m Beam

EXPLORER-1000
1,000 Lumens
600m Beam

ZOOM-110R
110 Lumens
35m Beam

ZOOM-370
370 Lumens
175m Beam

ZOOM-500
500 Lumens
285m Beam

ZOOM-1000R
1,000 Lumens
210m Beam

NAVIGATOR-310
310 Lumens
150m Beam



NAVIGATOR-620R
620 Lumens
175m Beam

NAVIGATOR-1100
1,100 Lumens
500m Beam

MAGNUM-3500
3,500 Lumens
700m Beam

MAGNUM-1100
1,100 Lumens
1,100m Beam

MAGNUM-11600
11,600 Lumens
525m Beam

NEW Explorer-XSR

NightSearcher

PROFESSIONAL FLASHLIGHTS

Compact USB Rechargeable LED Flashlight, 400 lumens

The Explorer-XSR is a powerful pocket-sized rechargeable LED flashlight with a 100 metre spot beam and 400 lumens light output with 3 light modes. Light and compact for everyday use, it is powered by a NightSearcher 14500 Li-ion rechargeable battery featuring a built-in micro-USB charging port that can be plugged into any available USB power source to keep you charged while you're on the go. Or can be used with 1 x Alkaline AA battery.



Stainless steel pocket/belt clip



SIMPLE RECHARGE



Supplied with a USB rechargeable Li-ion battery

OR

Can be used with 1 x AA Alkaline battery

KEY FEATURES:

- 400 Lumens
- 100 metre beam
- Runs up to 35 hours
- Rechargeable lithium battery 14500 - 3.7V 750mAh
- Aluminium housing - Type III hard anodised
- Ultra bright CREE XP-G2 LED
- 3 light modes: High/Medium/Low
- Knurled grip
- Tail cap switch
- Supplied with micro USB 3.7V Li-ion battery and charging cable

	HIGH	MEDIUM	LOW
LIGHT OUTPUT	400 LUMENS	40 LUMENS	10 LUMENS
Beam	100 METRES	20 METRES	10 METRES
RUN TIMES	1hrs	5hrs	35hrs
RECHARGEABLE LITHIUM BATTERY	IPX8 RATING	CHARGING TIME 2.5HRS	DIMENSIONS 102mm x19mm Diameter
			43g

PRODUCT CODE: NSEXPLORER-XSR



Explorer XML-X

Rechargeable, Robust, High Powered LED Flashlight, 600 lumens

The Explorer XML-X is a robust LED flashlight, ideal for domestic, security and emergency use. The flashlight comes complete with a wall mounted charging bracket which will automatically illuminate in the event of a power cut. A red cone is included in the box, ideal for traffic management and can be used as a warning light.



In the event of a power cut 6 white LEDs will illuminate automatically



The Explorer XML-X comes complete with wall mounting charging bracket

KEY FEATURES:

- Powerful 600 Lumens
- 500 metre beam
- Runs up to 15 hours
- Rechargeable lithium battery - 3.7V 2200mAh
- Wall mounted charging bracket
- 2 mode tail light tactical switch
- Compact and light weight flashlight
- Water and shock resistance
- Powerful CREE XML LEDs
- Battery level indicator
- Robust aluminium housing
- Shatterproof polycarbonate lens
- Supplied with wall mounting charging bracket, red cone, power cable, AC mains charger

	HIGH	LOW	FLASHING/SOS
LIGHT OUTPUT	600 LUMENS	60 LUMENS	600 LUMENS
Beam	500 METRES	50 METRES	500 METRES
RUN TIMES	1hrs 30MIN	15hrs	
RECHARGEABLE LITHIUM BATTERY	IP65 RATING	CHARGING TIME 6HRS	DIMENSIONS 120mm x190mm 70mm
			280g

PRODUCT CODE: NSEXPLORERXML-X



Includes a red cone for signalling



Optional yellow signalling cone: SPEXP-XML-CY

Optional accessories:



Vehicle Charger: CHICEXPLORER-XML

Dual Star

NightSearcher

PROFESSIONAL FLASHLIGHTS

2 IN 1 Rechargeable LED Flashlight and Work Light, 380 lumens

The Dual Star offers a high power spot beam, the torch can also be pulled up to change to lantern mode. The robust aluminium body and 1 metre impact resistance means it can be used in tough conditions. The ridged handle offers a secure grip. The dual star also works as a powerbank to charge your mobile phone or tablet!



KEY FEATURES:

- Powerful 380 Lumens
- Runs up to 10 hours
- 220 Metre beam
- Rechargeable lithium battery (3.7V 4400mAh)
- Long distance spot beam
- Pull up flood/lantern
- 4 modes: High, Low, Strobe and Flashing
- Ultra bright CREE XPG LED
- Battery status and charging indicator
- Powerbank - charge your phone/tablet
- Secure grip
- Robust aluminium housing
- Supplied with USB charging cable

	HIGH	LOW		
LIGHT OUTPUT	380 LUMENS	180 LUMENS		
Beam	220 METRES	150 METRES		
RUN TIMES	5hrs 30 MINS	10hrs		
RECHARGEABLE LITHIUM BATTERY	IP44 RATING	CHARGING TIME 8HRS	DIMENSIONS 181mmx 45mm DIAMETER	217g

PRODUCT CODE: NSDUALSTAR

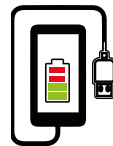

USB Power bank facility to charge your phone/tablet



Explorer 1000 - Powerful Long Spot Beam

Rechargeable Led Tactical Flashlight, 1,000 lumens

The Explorer-1000 is a professional rechargeable, LED tactical flashlight with a 600 metre spot beam and 1000 lumens light output with 6 light modes! You can easily cycle through the light modes using the through switch on the body, also illuminates the battery status. The flashlight is type III anodised aluminium and incorporates a secure grip, and has a 1.5m impact resistance.

NightSearcher

PROFESSIONAL FLASHLIGHTS



KEY FEATURES:

- 1,000 Lumens
- 600 metre beam
- Runs up to 50 hours
- Rechargeable lithium battery - 3.7V 2600mAh
- Aluminium housing - Type III hard anodised
- Ultra Bright CREE XLAMP XML U2 LED
- 2 Hidden light modes: Strobe/SOS
- Knurled grip
- 2 switches - tail cap tactical and body
- Through switch battery status indicator
- Supplied with USB charging cable

	100%	60%	30%	5%	STROBE/SOS
LIGHT OUTPUT	1,000 LUMENS	600 LUMENS	300 LUMENS	50 LUMENS	1000 LUMENS
Beam	600 METRES	445 METRES	300 METRES	175 METRES	600 METRES
RUN TIMES	2hrs 36MIN	4hrs 18MIN	8hrs 30MIN	50hrs	2hrs 40MIN
RECHARGEABLE LITHIUM BATTERY	IPX7 RATING	CHARGING TIME 6HRS	DIMENSIONS 165mm x 36mm Diameter	211g	

PRODUCT CODE: NSEXPLORER1000

Optional Holsters:



SP-MEGAZOOM-HOLSTER SPHOLSTER



SPEXPHOLB

Optional accessories:

- 12/24V Vehicle charger: CHIC3_7-Lithium
- UK OR EU USB Charging adaptor: CH-USB-UK/EU



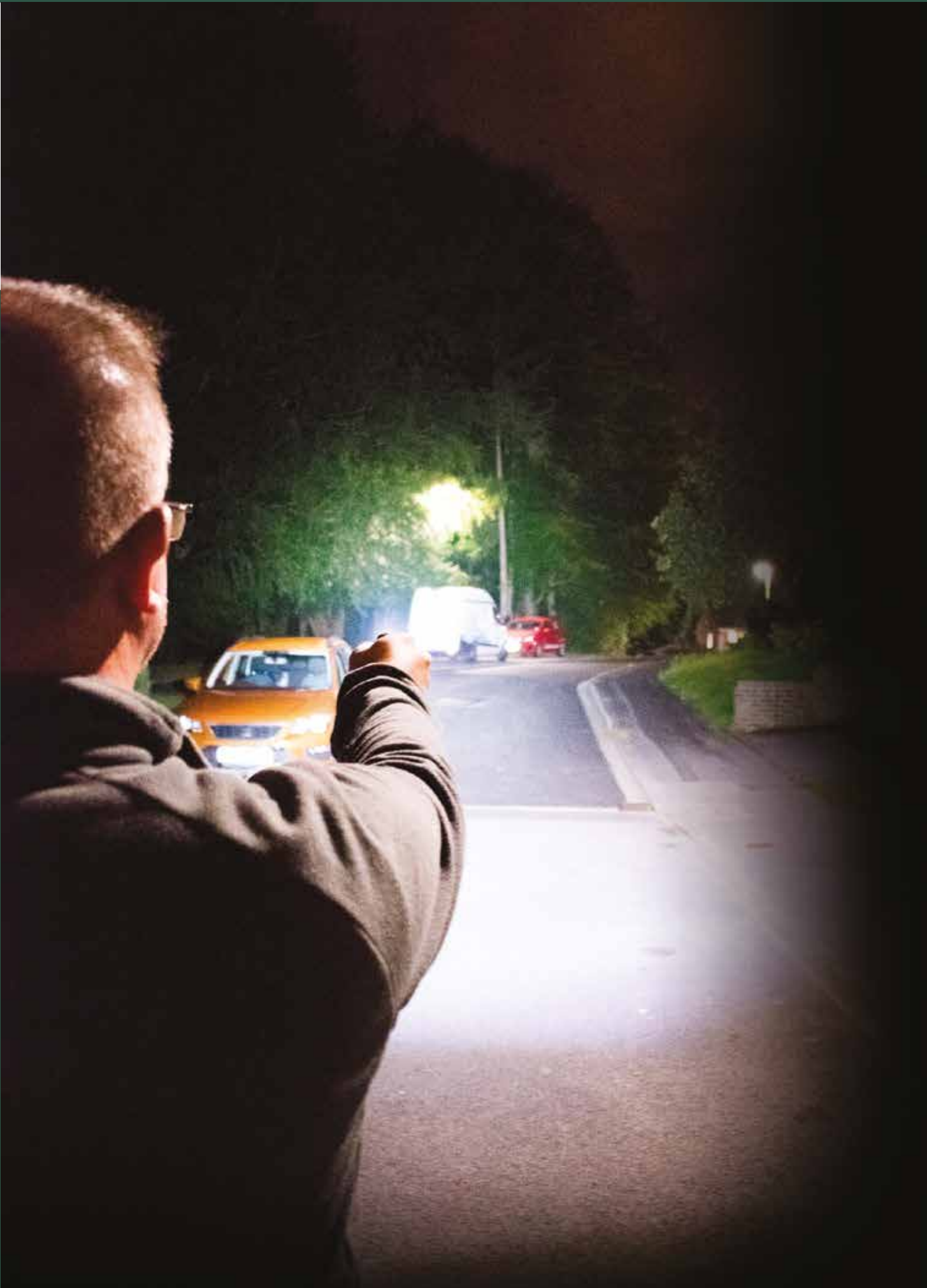

KeyStar - Rechargeable

NIGHTSEARCHER LIGHTING TECHNOLOGY



SAFETY LOCK

Hold down light mode switch to lock the flashlight. Whilst flashlight is off; hold down button for 5 seconds to lock. To unlock the flashlight; hold down button for 5 seconds.

Dimming function

Hold down light mode switch to dim or brighten. When lightest/darkest limits are reached whilst dimming the light will flash twice.



Brightness memory function

Previous brightness level setting will always be memorised and will resume when torch's light is switched back on again.



Through Switch

Battery status and charging indicator

Keychain with Searchlight Performance, 300 Lumens

This tiny rechargeable KeyStar has an impressive searchlight worthy performance! With a 300 lumen light output and a beam of 110 metres you will definitely find your way around in the dark. The perfect carry around that takes little space on your key ring or chain, at less than 30 grams the Key-Star travels with you in your pocket or handbag, and provides light and safety where and when you need it.



KEY FEATURES:

- 300 Lumens
- 110 metre beam
- Runs up to 17 hours
- USB rechargeable lithium battery - 3.7V 600mAh
- Secure grip
- Ultra bright CREE XP-L LED
- Through switch battery status and charging indicator
- Lock mode (on/off switch)
- Brightness memory function
- Dimmable
- Supplied with USB charging cable



300 LUMENS



110 METRES



17hrs



PRODUCT CODE: NSKEYSTAR

Optional accessories:

EU Adaptor: CH-USB-EU
AC Adaptor: CH-USB-UK

Zoom Focus Beam Range



Optional Holsters:
SP-MEGAZOOM-HOLSTER
SPHOLSTER

Zoom 370

Spot to Flood Zoom Flashlight
370 lumens, 2 x AA

KEY FEATURES:

- 370 Lumens
- 175 metre beam
- Runs up to 60 hours
- Advanced optical focus systems
- Knurled grip
- Aluminium housing - Type III hard anodised
- Ultra Bright CREE XP-G2 LED
- 5 mode tail cap tactical switch
- Supplied with 2 x AA alkaline batteries and wrist strap

	BOOST	HIGH	MEDIUM	LOW	FLASHING
LIGHT OUTPUT	370 LUMENS	260 LUMENS	130 LUMENS	30 LUMENS	8HZ
BEAM	175 METRES	145 METRES	105 METRES	50 METRES	
RUN TIMES	2hrs	5hrs	13hrs	60hrs	
2xAA BATTERY	IP65 RATING	DIMENSIONS 158mm x29mm Diameter	150g		

PRODUCT CODE: NSZOOM370



Zoom 500

Spot to Flood Zoom Flashlight
500 lumens, 4 x AAA

KEY FEATURES:

- 500 Lumens
- 285 metre beam
- Runs up to 45 hours
- Advanced optical focus systems
- Knurled grip
- Aluminium housing - Type III hard anodised
- Ultra Bright CREE XP-G2 LED
- 5 mode tail cap tactical switch
- Supplied with 4 x AAA alkaline batteries and wrist strap

	BOOST	HIGH	MEDIUM	LOW	FLASHING
LIGHT OUTPUT	500 LUMENS	300 LUMENS	150 LUMENS	20 LUMENS	8HZ
BEAM	285 METRES	230 METRES	165 METRES	65 METRES	
RUN TIMES	1hrs	2hrs	6hrs 30MIN	45hrs	
4xAAA BATTERY	IP66 RATING	DIMENSIONS 129mm x38mm Diameter	172g		

PRODUCT CODE: NSZOOM500

Optional signalling cones:
RED: SPEXP-XML-CR
YELLOW: SPEXP-XML-CY



Optional Holsters:
SP-MEGAZOOM-HOLSTER
SPHOLSTER

Zoom Focus Beam Range - Rechargeable

Spot - Flood
Zoom Beams

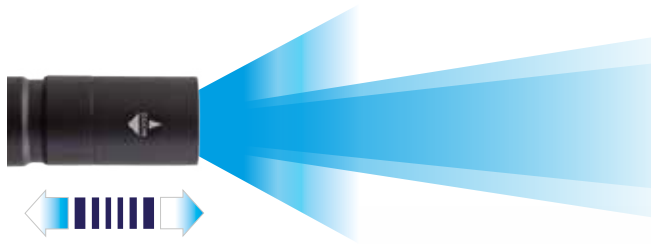

Zoom Focus
Pull bezel to zoom
from spot to flood

Zoom 110R

Spot to Flood Zoom Rechargeable
Flashlight, 110 lumens

KEY FEATURES:

- Powerful 110 Lumens
- 35 metre beam
- Runs up to 16 hours
- Advanced optical focus systems
- Rechargeable lithium battery - 3.7V 320mAh
- Knurled grip
- Aluminium housing
- Type III hard anodised
- Ultra Bright LED
- Pocket/belt clip
- 3 mode tail cap tactical switch
- Magnetic base
- Supplied with USB charging cable



	HIGH	MEDIUM	LOW
LIGHT OUTPUT	110 LUMENS	55 LUMENS	10 LUMENS
Beam	35 METRES	22 METRES	10 METRES
RUN TIMES	2hrs 30MIN	5hrs 30MIN	16hrs
RECHARGEABLE LITHIUM BATTERY	IP64 RATING	CHARGING TIME 1.5HRS	Dimensions 128mm x18mm Diameter
			52g

PRODUCT CODE: NSZOOM110R



Battery status indicator

Zoom 1000R

Spot to Flood Zoom Rechargeable
Flashlight, 1,000 lumens

KEY FEATURES:

- Powerful 1,000 Lumens
- 210 metre beam
- Runs up to 50 hours
- Advanced optical focus systems
- Rechargeable lithium battery - 3.7V 2600mAh
- Knurled grip
- Aluminium housing - Type III hard anodised
- Ultra Bright XP-L CREE LED
- 5 mode tail cap tactical switch
- Supplied with USB charging cable and wrist strap

	BOOST	HIGH	MEDIUM	LOW	FLASHING
LIGHT OUTPUT	1,000 LUMENS	500 LUMENS	200 LUMENS	50 LUMENS	8HZ
Beam	210 METRES	145 METRES	95 METRES	50 METRES	
RUN TIMES	4hrs	7hrs	15hrs	50hrs	
RECHARGEABLE LITHIUM BATTERY	IP66 RATING	CHARGING TIME 4HRS	DIMENSIONS 141mm x29mm Diameter		166g

PRODUCT CODE: NSZOOM1000R

OPTIONAL ACCESSORIES:



12/24V Vehicle
Charger:
CHIC3_7-LITHIUM

AC Adaptor:
CH-USB-UK

EU Adaptor:
CH-USB-EU

Holsters:
SP-MEGAZOOM-HOLSTER
SPHOLSTER

Navigator Flashlight Range

NIGHTSEARCHER LIGHTING TECHNOLOGY



Lock mode

Hold down light mode switch to lock the flashlight. Whilst flashlight is off; hold down button for 5 seconds to lock. To unlock the flashlight; hold down button for 5 seconds.

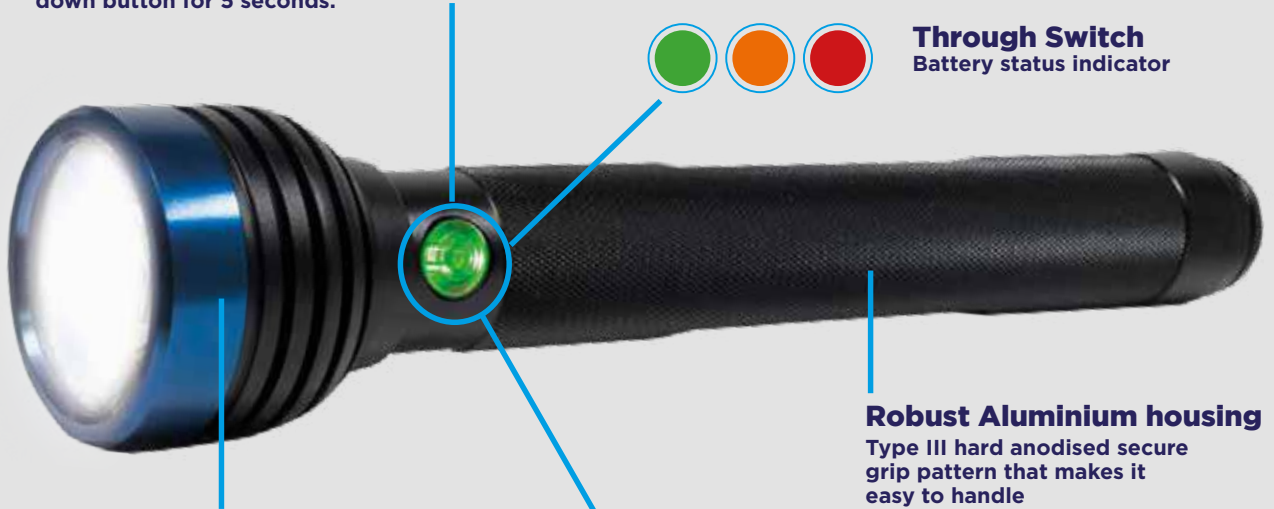

Through Switch
Battery status indicator



Robust Aluminium housing
Type III hard anodised secure grip pattern that makes it easy to handle



Brightness memory function

Previous brightness level setting will always be memorised and will resume when torch's light is switched back on again.

Dimming function

Hold down light mode switch to dim or brighten. When lightest/darkest limits are reached whilst dimming the light will flash twice.

Navigator 310

2 x AA, Pocket Sized LED Flashlight, 310 lumens



KEY FEATURES:

- 310 Lumens
- 150 metre beam
- Runs up to 4 hours
- Knurled grip
- Aluminium housing - Type III hard anodised
- Ultra bright CREE XP-G2 LED
- Through switch battery status and charging indicator
- Brightness memory function
- Dimmable
- 2 x AA alkaline batteries (not included)



310
LUMENS



150
METRES



4hrs



DIMENSIONS
161mm
x26mm
Diameter

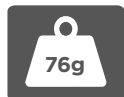

76g

PRODUCT CODE: NSNAVIGATOR310



Optional Holsters:
SP-MEGAZOOM-HOLSTER
SPHOLSTER

Navigator Flashlight Range

Navigator 620R

Ultra Bright LED Rechargeable Pocket Sized Flashlight, 620 lumens



KEY FEATURES:

- 620 Lumens
- 175 metre beam
- Runs up to 6 hours
- Rechargeable lithium battery (2x18650/CR123)
- Knurled grip
- Aluminium housing - Type III hard anodised
- Ultra bright CREE XP-L LED
- Through switch battery status and charging indicator
- Brightness memory function
- Dimmable
- Supplied with USB charging cable



620 LUMENS



175 METRES



6hrs



PRODUCT CODE: NSNAVIGATOR620R

Optional accessories:

- 12/24V Vehicle Charger: CHIC3_7-Lithium
- USB Charging Adaptor: CH-USB-EU



Optional Holsters:

- SP-MEGAZOOM-HOLSTER
- SPHOLSTER

Navigator 1100

4 x C, Ultra Bright LED Flashlight, 1,100 lumens



KEY FEATURES:

- 1,100 Lumens
- 500 metre beam
- Runs up to 8 hours
- Knurled grip
- Aluminium housing - Type III hard anodised
- Ultra bright CREE XP-L2 LED
- Through switch battery status indicator
- Brightness memory function
- Dimmable
- 4 x C alkaline batteries (not included)



1,100 LUMENS



500 METRES



8hrs

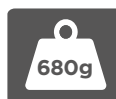

PRODUCT CODE: NSNAVIGATOR1100

Astonishingly Long Distance Spot Beam - Magnum-1100

Rechargeable LED Flashlight, 1,100 lumens

The Magnum-1100 is a professional rechargeable, LED flashlight. It has a staggering spot beam of 1100 metres powered from the 1100 lumens, super bright Cree® LEDs. The flashlight has 5 light modes making this torch suitable for almost any situations. The tough body is made from type III anodised aluminium housing and ideal for security, emergency services, scenes of crime, search and rescue sectors.



1,100 metre
Narrow search beam



Transportation lock - prevents the light from being turned on accidentally

KEY FEATURES:

- 1,100 Lumens
- 1,100 metre beam
- Runs up to 26 hours
- Rechargeable lithium battery
7.4V 2600mAh or 3 x C alkaline batteries (not included)
- Aluminium housing - Type III hard anodised
- Ultra bright CREE XHP70 N4 LED
- Transportation Lock - prevents the light from being turned on accidentally
- Knurled grip
- Battery status and charging indicator
- Supplied with mains charger and carry strap

	BOOST	HIGH	MEDIUM	LOW	FLASHING
LIGHT OUTPUT	1,100 LUMENS	600 LUMENS	350 LUMENS	100 LUMENS	8Hz
Beam	1,100 METRES	760 METRES	620 METRES	315 METRES	
RUN TIMES	1hrs 30MIN	8hrs	13hrs	26hrs	8hrs
RECHARGEABLE LITHIUM BATTERY	IP67 RATING	CHARGING TIME 6HRS	835g	DIMENSIONS 265mm x 90mm Diameter	

PRODUCT CODE: NSMAGNUM1100



Ultra Wide Flood Beam - Magnum-11600

NightSearcher's Most Powerful Rechargeable LED Flashlight, 11,600 lumens

This NightSearcher Magnum offers an outstanding 11,600 lumen output, making it NightSearcher's most powerful rechargeable flashlight. The Ultra bright XHP CREE LEDs and will last for 3 hours on the Boost setting. Ideal for security, emergency services, scenes of crime, search and rescue sectors.

NightSearcher



KEY FEATURES:

- 11,600 Lumens
- 525 metre beam
- Runs up to 54 hours
- Ultra bright 4 x XHP CREE White LEDs
- Rechargeable lithium battery - 7.4V 7800mAh or 3 x C alkaline batteries (not included)
- Aluminium housing - Type III hard anodised
- Ultra bright CREE XHP70 N4 LED
- Transportation Lock - prevents the light from being turned on accidentally
- Rotational light mode dial
- Knurled grip
- Battery status and charging indicator
- Supplied with mains charger and carry strap

	BOOST	HIGH	MEDIUM	LOW	ECO	FLASHING
LIGHT OUTPUT	11,600 LUMENS	5,000 LUMENS	1,500 LUMENS	600 LUMENS	180 LUMENS	8Hz
Beam	525 METRES	315 METRES	178 METRES	154 METRES	62 METRES	
RUN TIMES	3hrs	4hrs	7hrs	15hrs	54hrs	15hrs
RECHARGEABLE LITHIUM BATTERY	IP67 RATING	CHARGING TIME 9HRS	1.235 KG	DIMENSIONS 273mm x95mm Diameter		

PRODUCT CODE: NSMAGNUM11600

PROFESSIONAL FLASHLIGHTS



Powerful Wide Flood Beam - Magnum-3500

Rechargeable LED Flashlight, 3,500 lumens

Magnum-3500 rechargeable LED torch is a professional flashlight. It has a staggering 3,500 lumen light output with a 700 metre beam, coming from super bright Cree® XHP70 LEDs. Ideal for security, emergency services, scenes of crime, search and rescue sectors.



3,500 metre
Wide angled beam



KEY FEATURES:

- 3,500 Lumens
- 700 metre beam
- Runs up to 290 hours
- Rechargeable lithium battery - 3.7V 5000mAh
- Aluminium housing - Type III hard anodised
- Ultra bright CREE XHP70 N4 LED
- 7 light modes: Strobe/SOS
- Knurled grip
- Memory function
- Through switch battery status indicator
- Supplied with USB AC charger

	100%	30%	15%	2%	2%	STROBE/SOS
LIGHT OUTPUT	3,500 LUMENS	1,200 LUMENS	450 LUMENS	90 LUMENS	13 LUMENS	1,000 LUMENS
Beam	700 METRES	560 METRES	420 METRES	195 METRES	145 METRES	
RUN TIMES	1hrs	1hrs 54MIN	4hrs 30MIN	29hrs	290 hrs	1hrs 9MIN
RECHARGEABLE LITHIUM BATTERY						
IPX8 RATING						
CHARGING TIME 6HRS						
470g						
DIMENSIONS 293mm x 67mm Diameter						

PRODUCT CODE: NSMAGNUM3500

Optional accessories:

12/24V Vehicle Charger: CHIC3_7-LITHIUM

EU USB Charging Adaptor: CH-USB-EU



18650 USB

USB Rechargeable Lithium-ion Battery

The NightSearcher BA18650-USB is a premium quality high capacity, 2600 mAh USB rechargeable lithium-ion battery, that has a built-in micro-USB charging port making charging on the go easier than ever! Conveniently charge the battery using any USB power source such as a USB wall charger, computer/laptop, power bank, or automotive USB port using micro USB cable. It also includes a protection circuit to help prevent short circuits, over charge/discharge and over heating.



Features charging status indicator



Charged



Charging



USB rechargeable 2600mAh 18650 lithium-ion battery charges in 5 hours

KEY FEATURES:

- Safety control circuit
- Fully compliant with UN38.3
- Micro USB port
- Charges in 5 hours
- 18Ø x 70mm
- 47g
- 1 year warranty

PRODUCT CODE: BA18650-USB

Compatible with the following flashlights and head torches:



NAVIGATOR-620R

1x18650



UV365

1x18650



LIGHTWAVE

1x18650



HT800RX

1x18650

UV395

UV 395nm LED Flashlight

The UV395 is a compact and lightweight UV flashlight, which utilises the latest in UV technology. Featuring a powerful LED emitting an Ultra-violet beam. The UV395 flashlight is designed specifically for identifying counterfeit money, documents and passport.

NightSearcher



**ULTRA
VIOLET**

**3
YEAR
WARRANTY**

KEY FEATURES:

- 395nm wavelength
- Run up to 3.5 hours
- Knurled grip
- Lightweight design
- Aluminium housing - Type III hard anodised
- Tail cap tactical switch
- Water and shock resistant
- Powered by 2 x CR123A batteries
- (not supplied)

NightSearcher UV Flashlight are designed the following applications:



**LEAK
DETECTION**



**DETECTING
CRACKS**



**COUNTERFEIT
MONEY**



**FORENSIC
APPLICATIONS**



**COUNTERFEIT
DOCUMENTS**

Counterfeit money detection



Passport detection

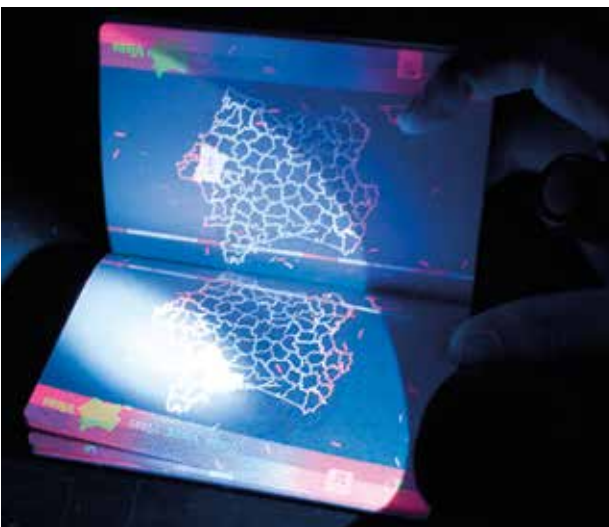

**395
nm**



3.5hrs



**DIMENSIONS
132mm
x33.5mm
Diameter**



PRODUCT CODE: NSUVLED395
CAT/PAD: 0111/112331



Optional Holsters:
SP-MEGAZOOM-HOLSTER
SP-HOLSTER

Forensic detection

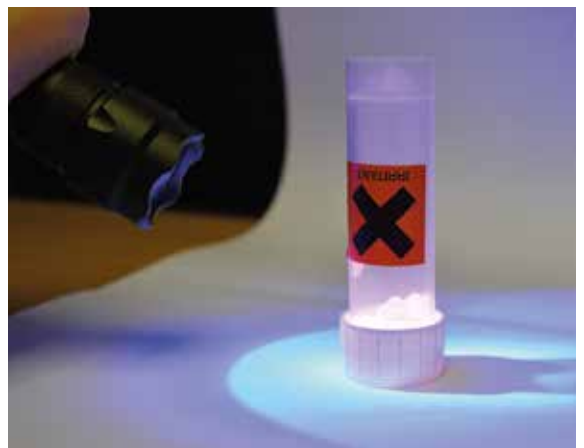

FORENSIC FLASHLIGHTS

UV365

Rechargeable UV 365nm LED Flashlight

The UV365 is a compact and lightweight UV flashlight, which utilises the latest in UV technology. Featuring a 6W powerful LED emitting a Ultra-violet beam. The UV365 flashlight is designed specifically for Forensic applications and Crime investigation.



KEY FEATURES:

- 365nm wavelength
- 1,030,000uW
- Run up to 3 hours
- Knurled grip
- Aluminium housing - Type III hard anodised
- Tail cap tactical switch
- Water and shock resistant
- Supplied with 12V-24V AC charger, Vehicle Charger 2x Rechargeable batteries, USB charging lead, and 2x O-rings.



Forensic Detection



365 nm



3hrs



30 METRES



PRODUCT CODE: NSUVLED365



Optional Holsters:



SP-MEGAZOOM-HOLSTER
SPHOLSTER



SPEXPHOLB



HT800RX

Rechargeable Proximity Distance Dimming LED Head Torch, 800 lumens

The 800RX can be recharged directly into the head torch or an optional spare battery can be purchased separately and charged in your car or from your computer. The 800RX uses advanced proximity distance dimming, which automatically changes from Narrow (long distance) to Wide beam (close up applications).



KEY FEATURES:

- 800 Lumens
- 550 metre beam
- Runs up to 169 hours
- Rechargeable lithium battery - 3.7V 2600mAh
- Ultra bright CREE XMG2 53 LED
- Battery charging and status Indicator
- Two rear warning light modes
- 90° rotational head
- Safety Lock: Prevents accidental power loss during storage or transportation.
- Wide flood beam
- Adjustable non-slip head straps
- Supplied with USB charging cable

	SPOT + FLOOD	FLOOD HIGH	FLOOD LOW	SPOT HIGH	SPOT LOW
	800 LUMENS	494 LUMENS	27 LUMENS	541 LUMENS	29 LUMENS
	550 METRES	500 METRES	250 METRES	500 METRES	250 METRES
	2hrs 30MIN	5hrs	169hrs	5hrs	169hrs
	RECHARGEABLE LITHIUM BATTERY	IP66 RATING	CHARGING TIME 5HRS	DIMENSIONS 46mm x85mm x39mm	230g

PRODUCT CODE: NSHT800RX
CAT/PAD: 0111/120695



PROXIMITY DIMMING

Automatically changes from (Long distance) **NARROW** to **WIDE** (Close up applications).



BRIGHTNESS MEMORY FUNCTION

Previous brightness level will be memorised and resume when turned on.

Two rear warning lights
battery status indicator



Can charge directly into head torch

OR

Optional spare batteries can be purchased separately and charged directly in your car or from your computer



Optional accessories:

- Battery: BA18650-USB
- Helmet Clips: SPPCLIPS
- AC Adaptor: CH-USB-UK
- EU Adaptor: CH-USB-EU
- 12/24V Vehicle Charger: CHIC3_7-LITHIUM

NEW HeadStar Pro

4 x AA - Proximity Distance Dimming LED Head Torch, 850 lumens

The HeadStar Pro uses advanced reactive distance sensors, which automatically adjusts from spot (long distance) to flood (closeup) beam according to its surroundings. Complete with two warm side lights for longer runtimes in low lighting and red, blue or green rear lights.



Non Rechargeable
Powered By 4X AA Alkaline Batteries

REAR LIGHTS

Red, Blue or Green choose from High or Flashing mode



KEY FEATURES:

- 850 Lumens
- 550 metre beam
- Runs up to 50 hours
- Wide flood beam
- Narrow long distance beam
- Powered by 4 x AA Alkaline batteries
- 180° beam angle adjustment
- Adjustable headband
- Helmet mountable with clips

	BOOST	NARROW HIGH	NARROW LOW	WIDE HIGH	WIDE LOW
LIGHT OUTPUT	850 LUMENS	620 LUMENS	45 LUMENS	590 LUMENS	37 LUMENS
Beam	550 METRES	500 METRES	169 METRES	5 METRES	169 METRES
RUN TIMES	2hrs 45MIN	4hrs	50hrs	4hrs	50hrs
4 XAA	IPX4 RATING		DIMENSIONS 46mm x85mm x39mm		291g

PRODUCT CODE: NSHEADSTAR-PRO

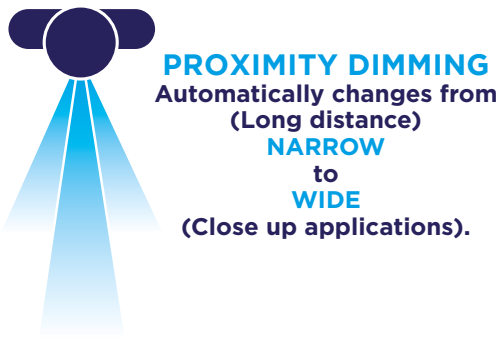

SAFETY LOCK
Prevents accidental power loss during storage or transportation.

BRIGHTNESS MEMORY FUNCTION
Previous brightness level will be memorised and resume when turned on.

WHITE SIDE LIGHTS
for low level lighting.



Optional accessories:



Helmet Clips: SPPCLIPS

Zoom 580 - Focus Beam Head Torch

Rechargeable Zoom LED Head Torch, 580 lumens

The ZOOM 580R head torch provides an easy switch from spot to flood beam, simply rotate the bezel to adjust from spot to flood. The Zoom 580R head torch has a unique feature of a removable lithium battery, and can also be used with 3 x AAA alkaline batteries.



KEY FEATURES:

- 580 Lumens
- 150 metre beam
- Runs up to 18 hours
- Rechargeable lithium battery - 3.7V 800mAh
- Can also work with 3 x AAA alkaline batteries
- Rotate bezel for spot to flood beam
- Cool white zoom beam
- Warm white diffused beam for close up work
- 90° beam angle adjustment
- Adjustable Headband
- Helmet mountable with clips
- Supplied with USB charging cable and rechargeable lithium battery pack

2 MODELS AVAILABLE:

ZOOM580

Powered by 3 x AAA Alkaline batteries



OR

ZOOM580R

Rechargeable lithium battery

Removable battery pack with Charging Indicator



For longer running times the ZOOM580R can be used with:



3 x AAA Alkaline Batteries

SPOT TO FLOOD COOL WHITE

CLOSE UP WARM WHITE

	HIGH	MEDIUM	LOW	LOW	FLASHING
LIGHT OUTPUT	580 LUMENS	270 LUMENS	30 LUMENS	10 LUMENS	2hz
Beam	150 METRES	100 METRES	35 METRES	5 METRES	
RUN TIMES	2hrs 30MIN	5hrs 30MIN	18hrs	15hrs	
RECHARGEABLE LITHIUM BATTERY	IP64 RATING	CHARGING TIME 2.5HRS	DIMENSIONS 62mm x41mm x43mm	95g	

Optional accessories:



Helmet Clips: SPPCLIPS



AC Adaptor: CH-USB-UK



12/24V Vehicle Charger: CHIC3_7-LITHIUM



EU Adaptor: CH-USB-EU

NEW HeadStar - Hybrid

Rechargeable Dual Beam LED Head Torch, 330 lumens

The HeadStar-R is a dual beam design offering a bright, narrow spot beam for long-distance lighting or a softer wide flood beam for close up targets, and a combined powerful 330-lumen, 130m boost beam for illuminating large areas. Its hybrid technology, means the HeadStar-R can be used either with the supplied rechargeable Lithium-polymer battery pack, or 3 x AAA Alkaline batteries.



KEY FEATURES:

- 330 Lumens
- 130 metre beam
- Runs up to 7 hours
- Rechargeable lithium-Polymer battery - 3.7V 800mAh
- Can also work with 3 x AAA alkaline batteries
- 90° beam angle adjustment
- Adjustable headband
- Helmet mountable with clips
- Supplied with rechargeable Lithium-Polymer battery or can be used with 3 x AAA Alkaline batteries (Not included).

	BOOST	NARROW	WIDE
	330 LUMENS	225 LUMENS	187 LUMENS
	5hrs	6hrs	7hrs
	130 METRES	120 METRES	37 METRES
RECHARGEABLE LITHIUM BATTERY	OR	3 XAAA	89g
			IPX4 RATING
			TIME 2.5HRS

PRODUCT CODE: NSHEADSTAR-R

Hybrid Technology:

Supplied with Rechargeable Lithium-Polymer battery



An extra rechargeable Lithium-Polymer battery can be purchased as a backup + can be charged directly through micro USB.



OR can be used with 3 x AAA Alkaline batteries (Not included)

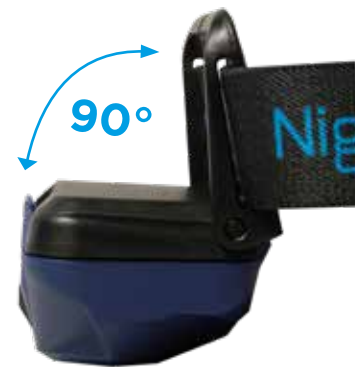

90° beam angle adjustment

Optional accessories:



Helmet Clips: SPPCLIPS



AC Adaptor: CH-USB-UK



SAFETY LOCK

Prevents accidental power loss during storage or transportation.



BRIGHTNESS MEMORY FUNCTION

Previous brightness level will be memorised and resume when turned on.



EU Adaptor: CH-USB-EU



12/24V Vehicle Charger: CHIC3_7-LITHIUM

Light Wave

Rechargeable Wide Beam LED Head Torch, 150 lumens

The Light Wave is a rechargeable wide beamed head torch, featuring the option smart on/off wave sensor to switch off the torch with a simple hand gesture. Ideal for when you have dirty hands or gloves on site, or carrying out outdoor activities and pursuits such as fishing, and climbing.



2 Ways To Turn ON+OFF

Manually using switch or Intelligent motion sensor.

Touchless wave control. Ideal when hands are dirty, wearing gloves, fishing or climbing

KEY FEATURES:

- 150 Lumens
- 20 metre beam
- Runs up to 8 hours
- Rechargeable lithium battery - 3.7V 2200mAh
- Wide beam area coverage
- Battery charging indicator
- Adjustable 180° housing
- Smart sensor indicator
- Motion sensor activated
- Diffused shadow and glare free lens
- Adjustable head strap
- 2 Hour charging time
- Supplied with USB charging cable

	HIGH	LOW
LIGHT OUTPUT	150 LUMENS	75 LUMENS
Beam	20 METRES	10 METRES
RUN TIMES	4hrs	8hrs
RECHARGEABLE LITHIUM BATTERY	IP44 RATING	CHARGING TIME 2HRS
	DIMENSIONS 79mm x45mm x35mm	160g

PRODUCT CODE: NSLIGHTWAVE



Wide flood beam

Optional accessories:

- Helmet Clips: SPPCLIPS
- AC Adaptor: CH-USB-UK
- EU Adaptor: CH-USB-EU
- 12/24V Vehicle Charger: CHIC3_7-Lithium

NEW Beanie-X

Rechargeable LED Beanie Head Torch

The NightSearcher Beanie head torch has been upgraded to the Beanie X. It now includes 4 light modes: A narrow long distance spot beam, a wide flood beam and Red light/flashing for preserve night vision. This warm beanie hat still includes the removable rechargeable LED Light and is ideal for hiking, runners, camping, dog walkers and tradesman.

NOW 3 TIMES BRIGHTER!

Three light modes: Spot, Flood and Red

KEY FEATURES:

- 200 lumens
- 25 metre beam
- Runtime 4-10 hours
- Rechargeable Lithium battery
- Cosy and warm
- One size fits all
- Removable light for charging LED and washing the beanie
- Ultra bright LEDs
- Recharges from any USB socket
- Battery charging indicator



Wide flood beam

	WIDE HIGH	WIDE MEDIUM	WIDE LOW	NARROW HIGH	RED HIGH	RED FLASHING
LIGHT OUTPUT	200 LUMENS	90 LUMENS	50 LUMENS	140 LUMENS	15 LUMENS	15 LUMENS
RUN TIMES	2hrs 30 MINS	5hrs 30 MINS	10hrs	4hrs	10hrs	6hrs 30 MINS
RECHARGEABLE LITHIUM BATTERY	IP65 RATING	CHARGING TIME 4HRS	38.5g			

PRODUCT CODE: NSBEANIE-X



Narrow spot beam



Removable Light For Charging LED And Washing The Beanie



Charge from computer or any USB Port



Red Light
Red Flashing Light



The charging indicator will glow red while charging and turn green once charged

ONE SIZE FITS ALL

Beanie Head Torch

USB Rechargeable LED Light

The NightSearcher Beanie head torch is supplied with an integral removable rechargeable LED Light. This warm and comfortable knitted hat is perfect for cold long dark winter nights. The light is easily removed for rechargeable from any USB socket. Ideal for electricians, builders, walkers etc.



KEY FEATURES:

- 150 lumens
- 14 metre beam
- Runtime 2-4 hours
- Rechargeable Lithium battery
- Cosy and warm
- One size fits all
- Removable light charging and washing
- 4 x Ultra bright LEDs
- Recharges from any USB socket
- Battery charging indicator

	HIGH	MEDIUM	LOW
LIGHT OUTPUT	150 LUMENS	100 LUMENS	50 LUMENS
RUN TIMES	2hrs	3hrs	4hrs
RECHARGEABLE LITHIUM BATTERY	IP65 RATING	CHARGING TIME 4HRS	21g

PRODUCT CODE: NSBEANIE-B

ONE SIZE FITS ALL



Removable Light For Charging And Washing



Charge in computer or any USB Port



The charging indicator will glow red while charging and turn green once charged

Hi-Vis Vest With Light

USB Rechargeable LED Light

Keep extra safe with NightSearchers Hi-Vis fire retardant EN standard safety vest, with removable LED USB Rechargeable light. The vests are made from high quality material and with an integrated rechargeable LED light which can be removed from the vest and recharged from any USB socket.



KEY FEATURES:

- 150 lumens
- 14 metre beam
- Runtime 2-4 hours
- Rechargeable Lithium battery
- EN ISO 20471, Class 2 certified safety work wear
- Removable light charging and washing
- 4 x Ultra bright LEDs
- Recharges from any USB socket
- Battery charging indicator

	HIGH	MEDIUM	LOW
LIGHT OUTPUT	150 LUMENS	100 LUMENS	50 LUMENS
RUN TIMES	2hrs	3hrs	4hrs
RECHARGEABLE LITHIUM BATTERY	IP65 RATING	CHARGING TIME 4HRS	21g

PRODUCT CODE: NSHIVISVEST-L/XL/XXL/3XL

4 sizes available: L | XL | XXL | 3XL

SIZE	A	B
L	120-128	160-175
XL	128-136	175-185
XXL	136-144	185-195
3XL	144-152	195-205

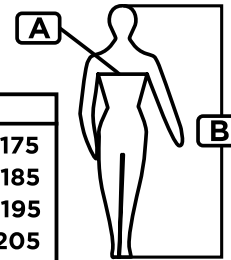

Removable Light For Charging And Washing



Charge in computer or any USB Port



The charging indicator will glow red while charging and turn green once charged

SAFATEX Range

Designed for use for oil & gas, petrochemical, aviation, marine, mining and utility applications.

Intrinsically Safe Explained -

Hazardous Area Classification Zone 0, Zone 1, Zone 2

This diagram shows how hazardous area zones may occur in typical circumstances:

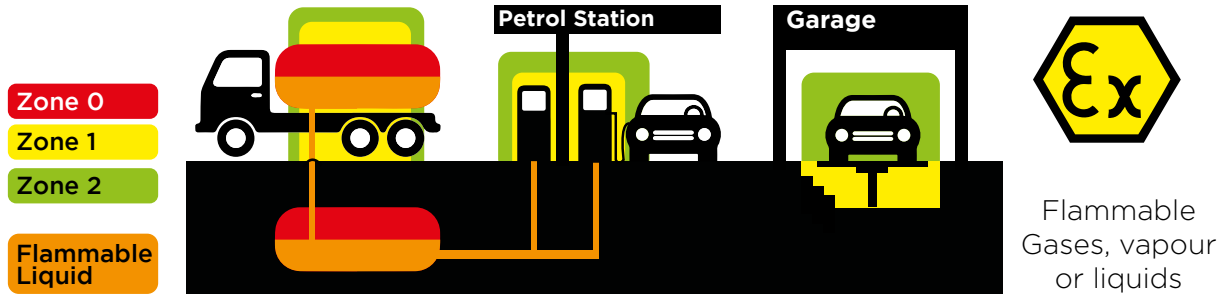

Hazardous Area Classification Zone 20, Zone 21, Zone 22

This diagram shows how hazardous area zones may occur in typical circumstances:

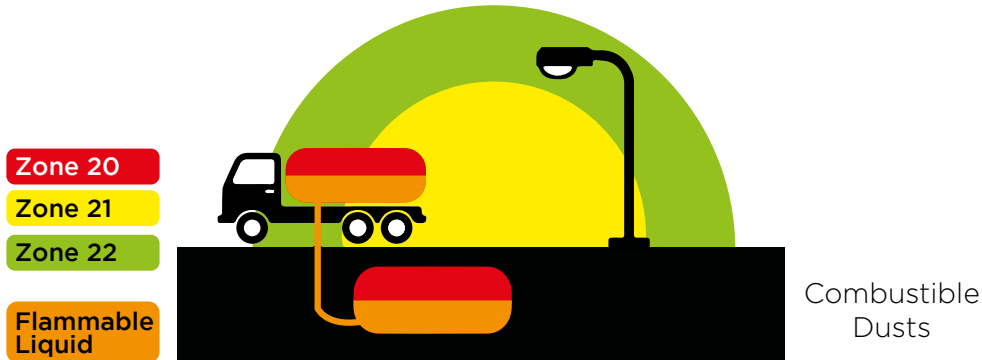

ATEX Marking

CE
CE mark denotes manufacturers' declaration of product compliance to all relevant EU Directives

Ex
Specific mark for Explosion Protection

I
Equipment Group (Mining)

M1
Equipment Category (Mining)

II
Not For Use In Mines

1
Atex Category 1 (Old Zone 0)

GD
Tested for Gases, Vapour and Dust Atmospheres

ATEX EX MARKING FOR EXPLOSIVE DUST ATMOSPHERES

Ex
Explosion Protected Equipment

ia
Intrinsic safe 'i'

IIIB
Dust Group

T130°C
Temperature Classification

Da
Equipment Protection Level

IP67
Ingress Protection Level Marking

ATEX EX MARKING FOR EXPLOSIVE GAS ATMOSPHERES

Ex
Explosion Protected Equipment

ia
Intrinsic Safe 'i'

I
Gas Group

Ma
Equipment Protection Level

IIC
Gas Group

T4
Temperature Classification

Ga
Equipment Protection Level

SAFATEX SL - Coming Soon

ATEX Rechargeable LED Searchlight, 370 lumens

The SAFATEX SL adds a searchlight to the NightSearcher ATEX product range. It features a convenient handle mounted switch which switches on and off the 369 lumen wide angle beam, perfect for lighting a broad area. The state of the art optics and reflector ensure a bright even spread of light and the lithium-ion battery provides up to 30 hours running time. For safety a gas release valve comes as standard.



KEY FEATURES:

- Powerful 370 Lumens
- 400 metre beam
- Runs up to 30 hours
- High powered LED
- Wide angled flood beam
- Removable shoulder strap
- Unique deep dish reflector
- Durable impact resistant, drop proof up to 1m
- Gas pressure release valve

MINING APPROVED

ZONES 0

3 YEAR WARRANTY

	HIGH	MEDIUM	LOW	
LIGHT OUTPUT	370 LUMENS	112 LUMENS	19 LUMENS	
RUN TIMES	4hrs	14hrs	30hrs	
Beam	400 METRES	215 METRES	87 METRES	
RECHARGEABLE LITHIUM BATTERY	CHARGING TIME 6.5HRS	IP54 RATING	DIMENSIONS 220mm 120x155mm	656 g

PRODUCT CODE: NSSAFA-SL



Wall mountable charging base



RoHS



CERTIFICATION:

- CLASS I DIV 1&2 GRP ABCD
TEMP CODE: T4 IP64
FILE NUMBER: 261379

- Gas: Ex II 1G EX IA OP IIC T4 GA (Zone 0)
Mining: EX I M1 EX IA I MA
Sira 17 ATEX2195X

- IECEx: GAS: Ex ia op is IIC T4 Ga (Zone 0)
MINING: Ex ia Ma
IECEx SIR 17.0042X

SAFATEX FLR

ATEX Rechargeable Portable LED Floodlight, 2100 lumens

The SAFATEX FLR is a portable, intrinsically safe rechargeable LED floodlight for use in zones 1, 2, 21 & 22 hazardous areas. This explosion proof floodlight is both compact and easy to use, offering an impressive 10 hours run time. This floodlight comes complete with magnetic feet or stainless steel stand.



Choice of Bases
Magnetic Feet **or**
Stainless Steel Stand



ZONES
1

DUST
ZONES
21

3
YEAR
WARRANTY

KEY FEATURES:

- Rechargeable lithium battery - 6.6Ah
- Intrinsically safe LED floodlights for use in hazardous areas
- Explosion proof
- High powered SEOUL LED
- Mount on stand or magnetic feet
- High strength aluminium housing
- Compact, ideal for confined spaces

CERTIFICATION:

- ATEX ZONE 1, 21
- ATEX ZONE 2 & 22
- Rohs
- IECEX
- IK 08
- ABS
- IP66
- CE
- Ex db op is II C T* Gb
- Ex tb op is IIIC T* Db



RoHS



2 MODELS AVAILABLE:

SAFATEX FLR - 1400 Lumens - 10W

SAFATEX FLR-X - 2100 Lumens - 15W



1400
LUMENS

2100
LUMENS



20
METRES

OR

30
METRES



10hrs

6hrs



PRODUCT CODE: NSSAFA-FLASTAND (With Stand)
NSSAFA-FLAMAG (Magnetic Feet)

PRODUCT CODE: NSSAFA-FLASTAND-X (With Stand)
NSSAFA-FLAMAG-X (Magnetic Feet)

NEW Optional accessories:
SPTRIPDSS

- Stainless Steel Tripod
- 3.6 metres maximum height



SAFATEX Floodlight

Atex LED Floodlight, 17,000 Lumens

The SAFATEX AC floodlight is an intrinsically safe LED floodlight for use in Zone 2 & Zone 22 hazardous areas. Typical applications include Gas station, manufacturing plants, chemical and petrochemical processing facilities, sewage treatment plants, off-shore, and dockside installations



0-360° Adjustable Brackets Included

GAS ZONES 2

DUST ZONES 22

3 YEAR WARRANTY

KEY FEATURES:

- 17,000 Lumens
- 43 metre beam
- AC 110/120 or 220/240V - 50/60Hz
- Intrinsically safe LED floodlight for use in hazardous areas
- High strength Aluminium housing
- Long range Floodlight
- Ultra bright high power OSRAM LED light output
- 120W

HIGH

LIGHT OUTPUT 17,000 LUMENS

Beam 43 METRES

110-240V AC

IP66 RATING

DIMENSIONS 425.5mmx 336mm

10.4 KG

PRODUCT CODE: NSSAFA-AC-FLO

CERTIFICATION:

- Ex nR IIC T5 or T6 Gc
- Ex tb IIIC T95°C or T85°C Dc IP66
- ATEX ZONE 2 & 22
- ATEX Certificate No.: TÜV 15 ATEX 7672 X
- Rohs
- ABS
- IK 08
- CE
- IP66



RoHS



Formally known as NSFLOOD1700

SAFATEX Linear Lights

6 Models Available: 24W, 36W, 50W, 60W, 72W and 80W

The SAFATEX liner range is a explosion proof light fittings suitable for surface mounted in zones 1, 2, 21 & 22 hazardous areas and is an ideal replacement for fluorescent light fittings.



2,712 lumens 24W



4,212 lumens 36W
7,380 lumens 60W



KEY FEATURES:

- AC 100-277V ~ 50/60Hz
- Low-profile, lightweight design
- High aluminium housing
- Impact resistant diffused lens
- Stainless steel bracket for ceiling mount
- Professional light distribution, uniformed illumination
- Single-ended feed-through cable or double ended optional
- Temperature class: T1 to T6
- Standard 6-12KV surge protection

36W



PRODUCT CODE: NSSAFA-AC-FLO-LIN-685

60W



PRODUCT CODE: NSSAFA-AC-FLO-LIN-1281

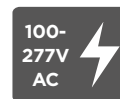

CERTIFICATION:

- ATEX Zone 1 & 21 and 2 & 22
- Ex II 2 G Ex emb IIC T6 Gb
- EX II 2 D Ex tb IIIC 80°C Db IP66



RoHS



SAFATEX FLAR

ATEX Rechargeable LED Flashlight, 157 lumens

The SAFATEX FLAR is an intrinsically safe, explosion proof rechargeable flashlight. It is made from high strength aluminium housing with a secure grip and offers a front torch light, along with a rear flood light.



ZONES
1

DUST ZONES
21

3 YEAR
WARRANTY

KEY FEATURES:

- 157 Lumens
- 200 metre beam
- Runtime 18.5 hours
- Rechargeable lithium battery - 2.2Ah
- High powered OSRAM LED
- High strength aluminium housing
- Durable impact resistant to 1m
- Gas pressure release valve
- Supplied with wrist strap

Front End Spot Light



SPOT

FLOOD



157
LUMENS

129
LUMENS



200
METRES

100
METRES



9hrs

18hrs
30 MINS



DIMENSIONS
156mm
x35mm
Diameter



PRODUCT CODE: NSSAFA-FLAR

Rear End Flood Light



CERTIFICATION:

- ATEX Zone 1 & 21 and 2 & 22
- Class I DIV 1 & 2 Groups A B C D
- Class II DIV 1 Groups E F G
- Class II DIV 2 Groups F G
- Class III DIV 1
- Class III DIV 2
- Ex ib IIC T4 Gb
- Ex tb IIIC T130°C Db IP68



RoHS



SAFATEX ZOOM

4 x AA, ATEX Spot to Flood LED Flashlight, 160 Lumens

The SAFATEX ZOOM is a zoom spot - flood flashlight, producing 160 lumens. Durable and drop-proof, the SAFATEX ZOOM is designed for easy, safe use in hazardous environments with a sliding switch for light modes and twistable head to switch between spot and flood lights.

Adjustable sliding switch between light modes



MINING APPROVED

ZONES 0

3 YEAR WARRANTY

KEY FEATURES:

- 160 Lumens
- 116 metre beam
- Runs up to 13 hours
- High powered LED - CREE XP-G2
- Beam Lock
- Adjustable sliding switch between light modes
- Twist head for Spot to Flood beam
- Waterproof up to 1m (IP67)
- Aluminium heat sink enhancing LED efficiency
- Durable impact resistant, drop proof up to 1m
- Gas pressure release valve
- Supplied with wrist strap
- Powered by 4 x AA batteries (not included)

Flood beam



Spot beam



	SPOT HIGH	SPOT LOW	FLOOD HIGH	FLOOD LOW
LIGHT OUTPUT	160 LUMENS	60 LUMENS	160 LUMENS	60 LUMENS
Beam	116 METRES	72 METRES	26 METRES	16 METRES
RUN TIMES	6hrs	13hrs	6hrs	13hrs
4XAA	IP67 RATING	DIMENSIONS 184mm x52mm Diameter	250g	

PRODUCT CODE: NSSAFA-FLA-ZOOM
Formally known as NSEXZOOM

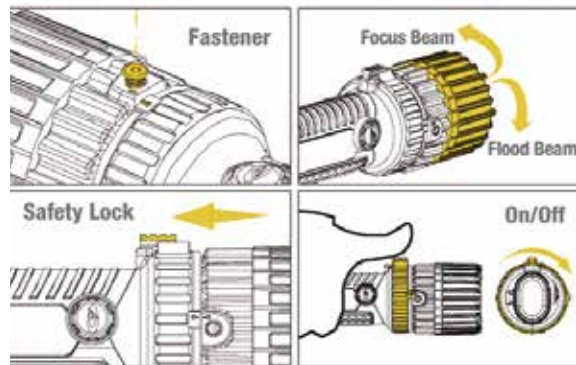

CERTIFICATION:

- CLASS I DIV 1&2 GRP ABCD
- CLASS II DIV 1&2 GRP EFG
- CLASS III TEMP CODE: T4 IP67
- ATEX: I M1 Ex ia I Ma
- Ex II 1G Ex ia IIC T4 Ga
- DEMKO 15 ATEX 1476X
- Ex ia I Ma
- Ex ia IIC T4 Ga
- IECEx UL 15.0046X



RoHS

SAFATEX PL

2 x AA, ATEX LED Penlight, 67 Lumens

The SAFATEX PL is an intrinsically safe penlight, it features a clip on the side. Making it easy to clip onto pockets, bags and belts.



MINING APPROVED

ZONES 0

3 YEAR WARRANTY

CERTIFICATION:

- CLASS I DIV 1&2 GRP ABCD
- CLASS II DIV 1&2 GRP EFG
- CLASS III
- TEMP CODE: T5 IP67
- FILE NUMBER E324236
- Atex: I M1 Ex ia I Ma
- Ex II 1G Ex ia IIC T5 Ga
- DEMKO 16 ATEX 1661X
- Ex ia I Ma
- Ex ia IIC T5 Ga
- IECEX UL 16.0015X



RoHS



KEY FEATURES:

- 67 Lumens
- 41 metre beam
- Runs up to 20.5 hours
- High powered LED - CREE XP-G2
- Lightweight pocket sized
- Pocket clip
- On/off tail switch
- Durable impact resistant, drop proof up to 1m
- Gas pressure release valve
- Supplied with wrist strap
- Powered by 2 x AA batteries (not included)



67 LUMENS



41 METRES



20hrs 30 MINS



IP67 RATING

DIMENSIONS 142X30 X26mm



41g

PRODUCT CODE: NSSAFA-FLA-PL

Formally known as NSEXPL

SAFATEX 3C

3 x C, ATEX LED Flashlight, 150 lumens, Long 80 Hours Runtime

SAFATEX 3C is a 3-C cell high capacity flashlight, giving a runtime of over 80 hours. It features a very handy removable clip allowing you to easily attach to overalls, jackets and clip boards.

Removable clip



ZONES 0

3 YEAR WARRANTY



RoHS



KEY FEATURES:

- Powerful 150 Lumens
- 248 metre beam
- Runs up to 80 hours
- High powered LED - CREE XP-E
- Removable clip
- On/off tail switch
- Durable impact resistant, drop proof up to 1m
- Gas pressure release valve
- Powered by 3 x C cell batteries (not included)



HIGH

150 LUMENS

LOW

57 LUMENS



248 METRES

154 METRES



80hrs

42hrs 30 MINS



IP67 RATING

DIMENSIONS 225X60 X80mm



190 g

PRODUCT CODE: NSSAFA-FLA-3C

Formally known as NSEX150

SAFATEX RA

NightSearcher

SAFATEX - INTRINSICALLY SAFE LIGHTS

4 x AA, Atex Right Angle Hand LED Torch, 325 Lumens

The SAFATEX RA is a right angled hand torch. The rugged torch has a robust polycarbonate housing and a rubberised head and grip for external durability. It features a has a very handy rear pocket clip allowing you to easily attach to overalls, jackets or belts.



Pocket/Belt stainless steel clip

**ZONES
0**

**MINING
APPROVED**

**3
YEAR
WARRANTY**

KEY FEATURES:

- 325 Lumens
- 290 metre beam
- Runs up to 13 hours
- High powered LED - CREE XP-G2
- Lockable battery compartment
- Robust Polycarbonate Housing
- Rubber grip and head for durability
- Pocket/Belt stainless steel clip
- Durable impact resistant, drop proof up to 1m
- Easy to use, maintenance free
- Gas pressure release valve
- Powered by 4 x AA batteries (not included)

	HIGH	LOW
LIGHT OUTPUT	325 LUMENS	140 LUMENS
Beam	290 METRES	184 METRES
RUN TIMES	6hrs 30 MINS	13hrs
4XAA	IP54 RATING	DIMENSIONS 183mm x69mm x63mm
		250g

PRODUCT CODE: NSSAFA-RAFLA

Formally known as NSEX325

CERTIFICATION:

- CLASS I DIV 1&2 GRP ABCD
CLASS II DIV 1&2 GRP EFG
CLASS III
TEMP CODE: T4 IP54
FILE NUMBER:261379

- ATEX: Ex I M1 Ex ia I Ma
Ex II 1G Ex ia IIC T4 Ga
Sira 15ATEX2166X

- IECEx: GAS:Ex ia IIC T4 Ga
MINING:Ex ia Ma
IECEX SIR 15.0062X



RoHS



Photo taken by faethon71

SAFATEX 4AA

4 x AA, ATEX LED Flashlight, 185 Lumens

The SAFATEX 4AA is a lightweight flashlight, it features a safety lock to prevent being accidentally switched on. Ideal for use in the fire & emergency services and utility companies.



Safety locks to prevent accidentally turning on

KEY FEATURES:

- 185 Lumens
- 117 metre beam
- Runs up to 30 hours
- High powered LED - CREE XP-G2
- Safety locks to prevent accidentally turning on
- Aluminium heat sink enhancing Led efficiency
- On/off tail switch
- Waterproof up to 3metres (IP68)
- Durable impact resistant, drop proof up to 1m
- Easy to use, maintenance free
- Gas pressure release valve
- Ideal for Oil and Gas Industry, Mining Industry, Utility Companies
- Supplied with wrist strap
- Powered by 4 x AA batteries (not included)



RoHS



PRODUCT CODE: NSEX185

CERTIFICATION:

- ATEX: Ex II 1 G | Ex ia IIC T4 IP68
- DEMKO 13 ATEX 1205039X
- Class I DIV 1 Groups A B C D
- Class II DIV 1 Groups E F G
- Class III DIV
- IECEx: Ex ia IIC T4 GA IECEx UL 13.0060X

	HIGH	LOW	FLASHING
LIGHT OUTPUT	185 LUMENS	70 LUMENS	180 LUMENS
Beam	117 METRES	83 METRES	117 METRES
RUN TIMES	8hrs	30hrs	
4XAA	IP68 RATING	DIMENSIONS 172mm x47mm Diameter	140g

PRODUCT CODE: NSSAFA-RAFLA-4AA

Formally known as NSEX185



SAFATEX HT MINI

3 x AAA, Compact ATEX LED Head Torch, 140 Lumens

The SAFATEX HT MINI is a compact ATEX head torch. Easy twist on and off bezel switch.



MINING APPROVED

ZONES 0

3 YEAR WARRANTY

KEY FEATURES:

- 140 Lumens
- 70 metre beam
- Runs up to 6 hours
- High powered LED - CREE XP-G2
- Adjustable headband to fit users head or helmet
- Aluminium heat sink enhancing LED efficiency
- Durable impact resistant, drop proof up to 1m
- Easily twist on/off bezel switch while wearing fire gloves
- Powered by 3 x AAA batteries (not included)

CERTIFICATION:

- Class I DIV 1 Groups A B C D
- Class II DIV 1 Groups E F G
- Class III DIV
- ATEX: M1 Ex: Ia | Ma
- II 1 G Ex ia IIC T4 GA
- DEMKO 15 ATEX 1546X
- IECEx: GAS: Ex ia IIC T4 GA
- MINE: Ex: Ia | Ma
- IECEx UL 15.0086X



140 LUMENS



86 METRES



6hrs



PRODUCT CODE: NSSAFA-HTMINI

Formally known as NSEXHT80

SAFATEX HT PRO

3 x AAA, ATEX LED Head Torch, 220 Lumens



ZONES 0

3 YEAR WARRANTY



RoHS



CERTIFICATION:

- Class I DIV 1 Groups A B C D
- Class II DIV 1 Groups E F G
- Class III DIV
- ATEX: II 1 G Ex ia IIC T4 GA IP67
- DEMKO 14 ATEX 1354X
- IECEx: Ex ia IIC T4 Ga IP67
- IECEx UL 14.0059x

KEY FEATURES:

- 220 Lumens
- 100 metre beam
- Run up to 12 hours
- High powered LED - CREE XP-G2
- Soft touch rubber switch
- 90° Adjustable angle
- Adjustable headband to fit users head or helmet
- Easily rotates while wearing fire gloves
- Powered by 3 x AAA batteries (not included)



HIGH
220 LUMENS

LOW
100 LUMENS



100 METRES

75 METRES



5hrs

12hrs



PRODUCT CODE: NSSAFA-HTPRO

Formally known as NSEXHT220

NEW Tri-Spector

3 in 1 Rechargeable LED Inspection Light Kit

The Tri-Spector, is a 3 in one inspection light kit, with quick release function enables user to change between 80 lumen torch with flexible light, a folding slimline 600 lumen inspection lamp with 180° tilt function, and features an additional LED directional torch, or a twist and swivel spot to flood flashlight. Features a magnetic base and hanging hook for hands free operation. All supplied in a robust carry case box.

INCLUDES:

- 1 x Flexible light - 80 Lumens
- 1 x Folding slimline light + torch - 600/300 Lumens
- 1 X Zoom focus flashlight Narrow to wide - 300 Lumens

KEY FEATURES:

- Three in one quick release inspection light
- 360° Rotating light head
- Powerful magnetic base
- Hanging hook
- 1 Metre impact resistant
- Rechargeable Lithium battery (3.7V 2600mAh)
- Battery status indicator
- Robust housing
- 4 hour charging time
- Resistant to chemicals & workshop solvents
- Supplied with AC adaptor + charging cable



Supplied in protective storage case

	FLEXIBLE LIGHT		FLASHLIGHT		FOLDING LIGHT + TORCH	
	HIGH	LOW	HIGH	LOW	TORCH	
LIGHT OUTPUT	80 LUMENS	300 LUMENS	100 LUMENS	600 LUMENS	300 LUMENS	100 LUMENS
RUN TIMES	10hrs	3hrs 30 MINS	6hrs 30 MINS	2hrs	3hrs 30 MINS	10hrs
Beam	10 METRES	30 METRES	15 METRES	10 METRES	5 METRES	10 METRES

RECHARGEABLE LITHIUM 3.7V 2600mAh BATTERY

IP44 RATING

CHARGING TIME 4HRS

PRODUCT CODE: NSTRI-SPECTOR

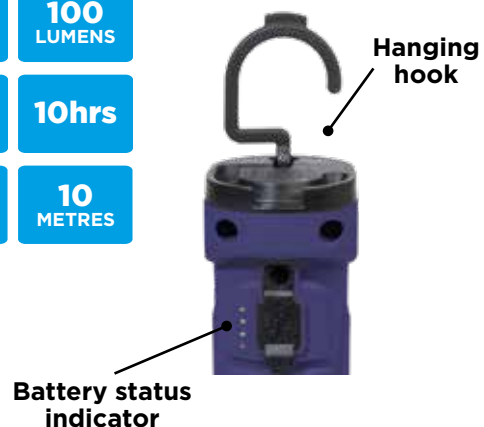

NEW i-Spector Flex

NightSearcher

Rechargeable LED Inspection Light

The i-Spector Flex is a rechargeable LED inspection lamp with a 360° flexible arm that fits into and illuminates even the most difficult-to-reach spaces. Perfect for under-bonnet inspection, the i-Spector Flex has a strong magnetic base, a hanging hook for hands-free work. The rotating dimmer switch allows the light to be easily adjusted from 50 to 500 lumens.



KEY FEATURES:

- 500 Lumens
- Runs up to 16 hours
- Rechargeable lithium battery (3.7V 2600mAh)
- Narrow beam torch
- Wide beam inspection light
- Adjustable dimming switch
- USB battery charging port
- Powerful magnetic base for hands free use
- 360° flexible arm
- Cordless heavy duty design
- Battery charging indicator
- 360° rotate and swivel hanging hook
- 4 hour charging time
- Resistant to chemicals & workshop solvents
- Supplied with: USB Adaptor + charging cable

	DIMMABLE WIDE BEAM	NARROW BEAM	
LIGHT OUTPUT	50-500 LUMENS	120 LUMENS	
RUN TIMES	2-16hrs	9hrs 30 MINS	
RECHARGEABLE LITHIUM BATTERY	IP54 RATING	CHARGING TIME 4HRS	DIMENSIONS 423mm x65.5mm x44.5mm
			290g

PRODUCT CODE: NSI-SPECTORFLEX



AUTOMOTIVE LIGHTS

NEW i-Spector Pocket

Rechargeable LED Pocket light

The i-Spector Pocket is a pocket-size inspection lamp. The wide beam COB LED light is perfect for close-up inspection work, and the narrow beam torch provides a bright spotlight. It has a strong magnetic base for hands free use, and the pocket clip allows you to have the light on hand whenever you need it.



KEY FEATURES:

- 350 Lumens
- Runs up to 5.5 hours
- Rechargeable lithium battery (3.7V 1100mAh)
- 10W COB LED - Floodlight
- Narrow beam torch
- Wide beam inspection light
- Powerful magnetic base and clip
- Belt/Pocket/tunic clip
- Battery charging indicator
- Cordless heavy duty design
- 4 hour charging time
- USB rechargeable
- Resistant to chemicals & workshop solvents
- Supplied with: USB Charging cable

	HIGH	LOW	TORCH
LIGHT OUTPUT	350 LUMENS	110 LUMENS	120 LUMENS
RUN TIMES	1.5hrs	5.5hrs	4.5hrs
RECHARGEABLE LITHIUM BATTERY	CHARGING TIME 3HRS	104g	DIMENSIONS 190mm x25mm x35mm

PRODUCT CODE: NSI-SPECTORPOCKET



Pro-250

NightSearcher

Rechargeable LED Inspection Light

The PRO250 is a rechargeable cordless LED inspection lamp, ideal for mechanics and for inspection work. It has 2 lights, a high power narrow torch beam and a wide flood beam. Supplied with a drop in charging base for easy recharge. The PRO250 can has a twist and swivel magnetic base for multi-directional lighting and hands free use.

KEY FEATURES:

- 250 Lumens
- Runs up to 6 hours
- Rechargeable lithium battery (3.7V 2200mAh)
- Produces clear white light
- Wide angle of light output that has uniform intensity
- USB Rechargeable and cordless
- Magnetic back and base for hands free use
- Battery status and charging
- Integrated foldable hanging hook
- Anti-slip comfortable grip
- Charging battery status indicators
- Resilient polycarbonate and ABS construction
- Supplied with: AC mains charger, 12V + 24V DC vehicle charger, charging base, Micro USB cable



	WIDE BEAM	NARROW BEAM
LIGHT OUTPUT	250 LUMENS	60 LUMENS
RUN TIMES	2.5hrs	6hrs
RECHARGEABLE LITHIUM BATTERY	CHARGING TIME 4HRS	DIMENSIONS 196mm x80mm Diameter
		320g

PRODUCT CODE: NSPRO250/-EU



AUTOMOTIVE LIGHTS

i-Spector 220

USB Rechargeable LED Inspection Light

The i-Spector220 is a unique inspection light, which separates to recharge through any USB socket. No Cable is required. It is constructed from robust ABS housing with rubber coating. Fitted with two magnets on the base and back plus handy hanging hook.



KEY FEATURES:

- 220 Lumens
- Runs up to 5 hours
- Rechargeable lithium battery (3.7V 2200mAh)
- USB battery charging port
- Strong magnetic base and back for hands free use
- 360° rotate and swivel hanging hook
- 2.2W COB Powerful LED
- Cordless heavy duty design
- Battery charging indicator
- Robust housing
- Resistant to chemicals & workshop solvents

	220 LUMENS		
	5hrs		

PRODUCT CODE: NSI-SPECTOR220



Light separates to recharge through any USB socket. No Cable required.

Supplied in a point of sale carton display packs, showcasing 6 x i-spector 220 inspector lights

Star Blade

NightSearcher

Ultra Slimline Rechargeable LED Inspection Light

The Star Blade is an ultra slim inspection light and the perfect tool for illuminating hard to reach areas. With an adjustable hook and magnetic base it's great for hands free use and the rechargeable 3.7V 2200mAh Lithium battery has 3 hours' runtime making the Star Blade an irreplaceable bit of kit for mechanics, plumbers, electricians and builders.

Slimline Design To Fit In
Hard To Reach Places

3
YEAR
WARRANTY



180° rotational
LED light

KEY FEATURES:

- 300 Lumens
- Runs up to 3 hours
- Rechargeable lithium battery (3.7V 2200mAh)
- Slim blade design
- Exceptional clear white light output
- Magnetic base for hands free use
- Integrated hanging hook
- Micro USB charging
- Charging Indicator
- Resilient polycarbonate and ABS construction
- Supplied with AC mains, DC vehicle charger, Micro USB cable



300
LUMENS



3hrs



PRODUCT CODE: NSSTARBLADE



AUTOMOTIVE LIGHTS

i-Spector 700

Rechargeable LED Inspection Light

The i-Spector 700 inspection light is ideal for mechanics, tradesmen and other inspection work. This robust inspection light has a cordless heavy duty design with a toughened optical lens. The housing is also resistant to chemicals and workshop solvents, ensuring it meets the demands of everyday use. The swivel base is magnetic and rotates 180°, also features a hanging hook which swivels 360°.



KEY FEATURES:

- 700 Lumens
- Runs up to 8 hours
- Rechargeable lithium battery (3.7V 2600mAh)
- Toughened optical lens
- Ultra bright 6W COB powerful LED
- Natural light 6500K
- Cordless heavy duty design
- Battery charging indicator
- 360° rotate and swivel hanging hook
- Robust housing - resistant to chemicals & workshop solvents
- Anti slip grip
- Strong magnetic base
- Supplied with AC charger

	HIGH	MEDIUM	LOW	TORCH
LIGHT OUTPUT	700 LUMENS	300 LUMENS	150 LUMENS	200 LUMENS
RUN TIMES	2hrs	4hrs	8hrs	8hrs
RECHARGEABLE LITHIUM BATTERY	IP54 RATING	CHARGING TIME 4HRS	DIMENSIONS 54mm x40mm x230mm	387g

PRODUCT CODE: NSISPECTOR700
CAT/PAD: 0111/114453



i-Spector 1000

NightSearcher

Rechargeable Wide Angled LED Inspection Light

The i-Spector 1000 is professional powerful inspection lamp. It has a wide angled 180° Illumination, that can be rotated and shines light straight to where it needed. It has a ultra strong magnetic base and hanging hook for hands free use. The inspection light features an adjustable dimming switch ideal for mechanics, tradesmen and other inspection work.

3
YEAR
WARRANTY

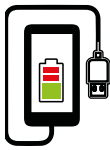

USB Power bank facility to charge your phone/tablet



Dimmable light switch

Magnetic base

KEY FEATURES:

- 1000 Lumens
- Runs up to 27 hours
- Rechargeable lithium battery (3.7V 5200mAh)
- 180° Illumination
- Adjustable dimming switch
- Wide angled beam
- Battery charging and status indicator
- ABS Plastic + PC lens
- Robust aluminium housing
- Bright SMD Led lights
- USB rechargeable
- Adjustable hanging hook
- Supplied with: AC charger and USB charging cable

	HIGH	DIMMABLE		
LIGHT OUTPUT	1000 LUMENS	60-1000 LUMENS		
RUN TIMES	2hrs	2-27hrs		
RECHARGEABLE LITHIUM BATTERY	IP54 RATING	CHARGING TIME 3.5HRS	DIMENSIONS 260mm x75mm Diameter	489g

PRODUCT CODE: NSI-SPECTOR1000

180° rotational LED light



AUTOMOTIVE LIGHTS

Micro-1000

Rechargeable LED Work Light

The Micro-1000 is ultra compact LED work light, that fits into the palm of your hand. The light is protect by the robust housing which can be rotated 360° and has a wide 90° flood beam. Ideal for use in confined spaces under flooring, kitchen cabinets etc or anywhere that you need bright portable lighting.



KEY FEATURES:

- 1000 Lumens
- Runs up to 2 hours
- Rechargeable lithium battery (3.7V 2600mAh)
- Compact design, fits in the palm of your hand
- 360° Multi directional lights
- Glass lens for 90° degrees
- Magnetic base
- Aluminium heat sink
- Battery status and charging indicator
- Battery overcharge + discharge protection
- Ideal light for compact areas
- Supplied with USB charging cable

	HIGH	LOW	
LIGHT OUTPUT	1000 LUMENS	500 LUMENS	
RUN TIMES	1hr	2hrs	220g
RECHARGEABLE LITHIUM BATTERY	IP65 RATING	CHARGING TIME 4HRS	DIMENSIONS 78mm x76mm x52mm

PRODUCT CODE: NSMICRO1000

OPTIONAL ACCESSORIES:



Vehicle Charger: AC Adaptor: CHIC8.4-Lithium CH-USB-UK

EU Adaptor: CH-USB-EU



Led Flashlight Perfect For Up Close Inspection

The PocketStar is a compact, pocket sized LED light, providing a powerful 150 Lumen flood light that is ideal for inspection work and general illumination. It has a durable ABS body with soft-touch rubber coating. The magnetic pocket clip allows the light to be attached to metal surfaces for hands free use and may be swivelled through 180 degrees to shine the light in the correct position







Magnetic pocket clip



Supplied in a point of sale carton display packs, showcasing 12x pocketstar flashlights

KEY FEATURES:

- 150 Lumens
- Runs up to 4 hours
- 180° swivel pocket clip
- Produces clear white light
- Wide angle beam
- LED Floodlight
- Polycarbonate lens
- Rubberised ABS yellow casing
- Anti slip grip handle
- Magnetic clip for hand free use
- Compact, pocket sized
- Resilient polycarbonate and ABS construction
- Supplied with 3 x AAA batteries

 LIGHT OUTPUT	HIGH 150 LUMENS
 RUN TIMES	4hrs
 3XAAA	DIMENSIONS 158mm x30mm x16.9mm
	 54g

PRODUCT CODE: NSPOCKETSTAR
CAT/PAD: 0111/120131

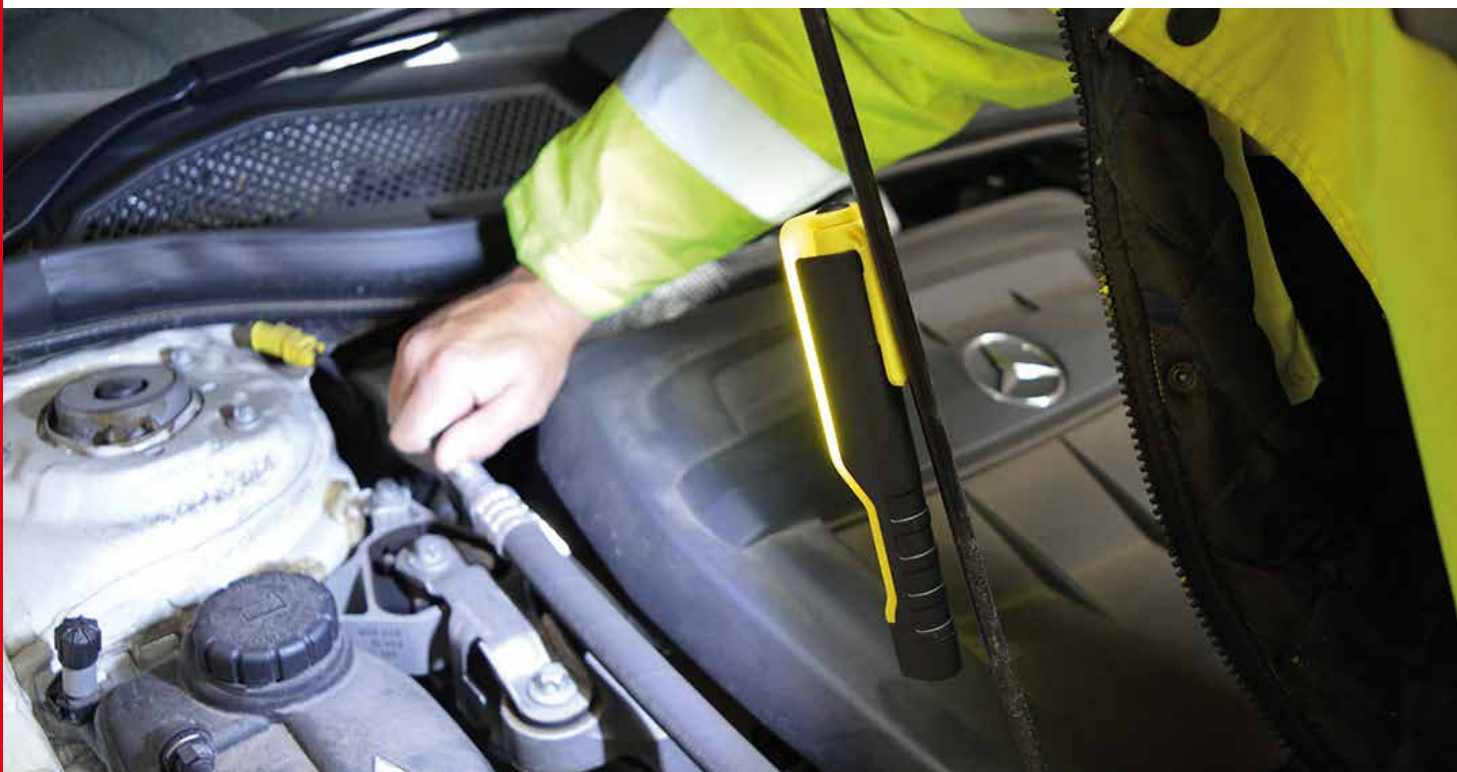

5 In 1 Emergency Car Kit

The LifeGuard is a car emergency kit all in one! This fantastic product is multifunctional, with a powerful floodlight and torch, a recessed razor blade cutter that frees both driver and passengers if seat belt locks, and a stainless steel emergency breaking pin that automatically deploys when pressed against side or rear window for glass breaking. The LifeGuard unit is magnetic so you can stick it to the outside of your car and use the emergency red flash warning light to get roadside assistance.



Window breaker
LED torch

5 In 1 Emergency Car

- Floodlight
- Inspection torch
- Window breaker
- Belt cutter
- Red flashing emergency lights



KEY FEATURES:

- 200 Lumens
- Runs up to 5 hours
- LED flood beam
- LED inspection torch
- Window breaker
- Belt cutter
- Red flashing emergency lights
- Ultra bright 2W COB LED strip
- Strong magnetic side
- Resilient polycarbonate + ABS construction
- Supplied with 3 x AAA batteries

	FLOODLIGHT	TORCH	FLASHING
LIGHT OUTPUT	200 LUMENS	70 LUMENS	200 LUMENS
RUN TIMES	2hrs 30MIN	3hrs	5hrs
3XAAA	DIMENSIONS 158mm x47.3mm	127g	

PRODUCT CODE: NSLIFEGUARD



StarBooster

NightSearcher

5 In 1 Emergency Car Kit Compact Portable Car Jump Booster, Essential Emergency Kit

The Star Booster is a multifunctional product which acts as a portable car jump starter, LED torch and floodlight with a flashing red emergency light. With its built in power bank, you can charge your mobile phone, tablet or laptop via micro USB. This compact unit is small enough to fit in your pocket or keep in the car glove box, providing an essential tool in emergencies.



KEY FEATURES:

- Floodlight: 500 Lumens
- Torch: Runs up to 75 hours
- Rechargeable lithium battery (3.7V 2600mAh)
- Jump starter up to 3.0 litre petrol and 2.0L Diesel engine
- Red flashing emergency lights
- Reverse polarity protection
- Supplied with insulated jump cables, USB cable, AC mains charger

FLOODLIGHT TORCH FLASHING

LIGHT OUTPUT	500 LUMENS	300 LUMENS	500 LUMENS
RUN TIMES	4hrs	7hrs 30MIN	75hrs
RECHARGEABLE LITHIUM BATTERY	CHARGING TIME 4HRS	DIMENSIONS 166mm x96mm	447g

MAX ENGINE SIZE

- 2.0L Petrol
- 3.0L Diesel



USB Power bank facility to charge your phone/tablet

PRODUCT CODE: NSSTARBOOSTER
CAT/PAD: 0111/113555



Compact size fits in your pocket

Emergency red flashing LED lights



NEW Galaxy Hazard

Rechargeable LED Hazard/ Work Light, Ideal For Use In Vehicles

The Galaxy Hazard is a powerful yet compact rechargeable LED work light. It has robust edge protection and is impact-resistant to 1 metre, easily withstanding knocks and bumps. Perfectly portable with a 180° folding carry handle/stand, with ultra integrated magnets and a power bank allows you to charge your mobile phones while you work.

Twin Light Modes:
Central white flood light
+
Red flashing triangle hazard light



BE SAFE BE SEEN AT THE ROADSIDE!

KEY FEATURES:

- 1,200 Lumens - 50 metre beam
- Runs up to 9 hours
- 2 Light modes: Central white flood light
Red flashing triangle hazard light
- Impact resistant to 1 metre
- Rechargeable lithium battery
- 2 x 3.7V 2200mAh
- USB rechargeable
- Magnetic carry handle
- Battery charging + status indicator
- Supplied with: USB Charging cable



USB Power bank facility to charge your phone/tablet



Fold flat design for compact storage



Heavy duty edge protection

Optional accessories:



EU Adaptor:
CH-USB-EU



12/24V Vehicle Charger:
CHIC3_7-LI-ION



AC Adaptor:
CH-USB-UK

	HIGH	LOW	RED FLASHING
LIGHT OUTPUT	1000 LUMENS	500 LUMENS	1200 LUMENS
Beam	50 METRES	25 METRES	50 METRES
RUN TIMES	3hrs 30 MINS	5hrs 30 MINS	9hrs
RECHARGEABLE LITHIUM BATTERY	CHARGING TIME 9HRS	DIMENSIONS 223mm x200mm x55mm	585g

PRODUCT CODE: NSGALAXYHAZARD



180° Degree foldable bracket/handle

NEW Pulsar Max

NightSearcher

WARNING LIGHTS

Highest Powered Rechargeable LED Hazard Lights

Set of four sequential rechargeable hazard lights, compliant with Traffic Signs Regulations and General Directions 2016, therefore suitable for use a 'advanced warning' to vehicles approaching an incident on a fast road. Fully compliant with the below standard thereby making the Pulsar Max suitable for use by Police, Fire and Highway Services as 'advanced warning' to vehicles approaching an incident on a fast road. They can also be used for general traffic control, signalling, hazard awareness, zone demarcations and vehicle safety.

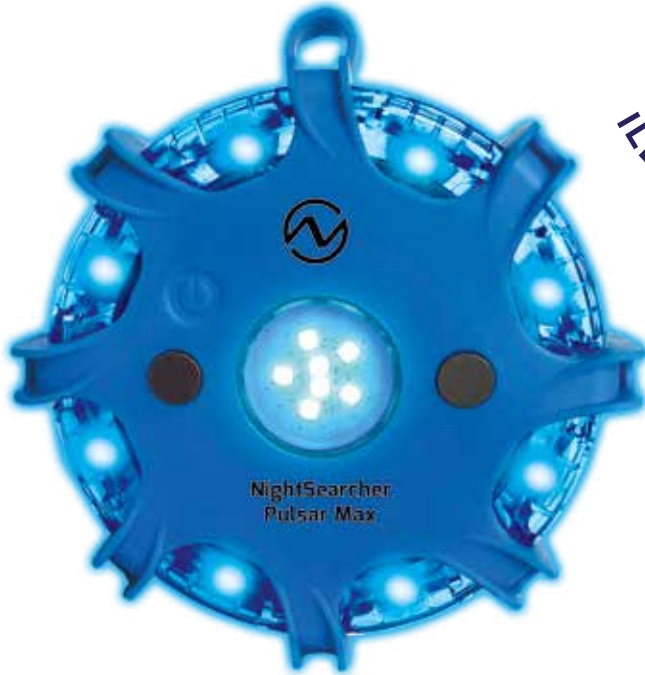

360°
ILLUMINATION

3
YEAR
WARRANTY



Conforms to Schedule 13, Part 10:
Traffic Signs Regulations and General Directions 2016 (TSRGD).

 RUN TIMES	60+ hrs				
RECHARGEABLE LITHIUM BATTERY	IP67 RATING 	CHARGING TIME 7HRS 	 2.65 kg	DIMENSIONS 380mm x370mm x65mm	3 YEAR WARRANTY

PRODUCT CODE: NPULSARMAX-B

Supplied with: Charging case, charging cable, car charger



Optional cone mount is available
SPPULSARMAG

NEW Sequential Pulsar Max

Highest Powered Sequential Rechargeable LED Hazard Lights

The Sequential Pulsar Max conforms to the same Traffic sign regulations as the Pulsar Max, but has the advantage of having a sequential flash operating mode. This provides a 'flow' effect of light as each Pod flashes in turn, ideal for use on high-speed roads where a greater distance is needed between light units.



360°
ILLUMINATION

3
YEAR
WARRANTY



NightSearcher

WARNING LIGHTS

Conforms to Schedule 13, Part 10:
Traffic Signs Regulations and General Directions 2016 (TSRGD).

RUN TIMES	60+ hrs			
RECHARGEABLE LITHIUM BATTERY	IP67 RATING 	CHARGING TIME 7HRS	2.65 kg	DIMENSIONS 380mm x370mm x65mm

PRODUCT CODE: NPULSARMAXSQ-B

KEY FEATURES:

- Visible from over 1 Kilometre
- 360° Illumination
- Rechargeable 3.7V 3000mAh lithium battery
- Waterproof up to 10m
- Floats in water
- Magnetic back
- Virtually indestructible
- Shock resistant plastic housing
- Working Temperature -40° to 60°C
- Pulsars can be charged either as a set within their case or as a single unit
- Supplied with: Charging case, charging cable, car charger



Crushproof - Up to 3 tonnes



Optional cone mount is available
SPPULSARMAG

Pulsar Pro Rechargeable

NightSearcher

WARNING LIGHTS

Emergency Rechargeable LED Hazard Lights

The PULSAR Pro is a multi-mode, rechargeable LED warning light designed for traffic control, signalling, hazard awareness, zone demarcations and vehicle safety. Ideal for professional applications, including the Police, Fire, and Highway Services. These small but robust units are manufactured in shock resistant plastic housing, are waterproof (up to 10 metres) and virtually indestructible (withstanding most vehicle weights if crushed). Built in magnets allow attachment to vehicles or any metal surfaces.



KEY FEATURES:

- Visible from over 1 Kilometre
- 360° Illumination
- 10 Light modes
- Waterproof up to 10m
- Floats in water
- Central white work lights
- Magnetic back
- Virtually indestructible
- Shock resistant plastic housing
- Working Temperature -40° to 60°C
- Designed for traffic control, signalling, hazard awareness, zone demarcations and vehicle safety including the Police, Fire and Highway Services.
- Supplied with: Charging base, charging cable, car charger

SOLD AS SINGLE RECHARGEABLE PULSAR

OR SET OF FIVE RECHARGEABLE PULSAR PRO



Recharges via inside charging case

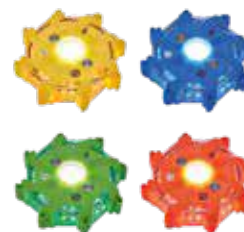

Run times for light modes:

Rotate	9hrs	Quad Flash	9hrs
Single Blink	60hrs	Alternating Blinks	9hrs
SOS Rescue	14hrs	Steady on High	5hrs
Steady on Low	35hrs	2 LED Lights	28hrs
4 LED Lights	18hrs	White Torch Mode	8hrs

RECHARGEABLE LITHIUM BATTERY	IP67 RATING	CHARGING TIME 10HRS	DIMENSIONS 24mm x110mm Diameter	200g
------------------------------------	----------------	------------------------	--	------

Single Rechargeable Pulsar

PRODUCT CODE:	MILLICANDELA (MDC)
NSPULSARPRO-B: Blue	6,000
NSPULSARPRO-G: Green	11,000
NSPULSARPRO-R: Red	7,000
NSPULSARPRO-Y: Yellow	7,500

Set of Five Rechargeable Pulsar Pro

PRODUCT CODE:	MILLICANDELA (MDC)
NSPULSARPRO5-B: Blue	6,000
NSPULSARPRO5-G: Green	11,000
NSPULSARPRO5-R: Red	7,000
NSPULSARPRO5-Y: Yellow	7,500
CAT/PAD:	0111/107593

OPTIONAL ACCESSORIES:



See the Pulsar Pro video



Video Link



Crushproof - Up to 3 tonnes

Sequential Rechargeable Pulsar Pro

Set of Five LED Hazard Warning Lights

This sequential version of Pulsar Pro has the advantage of having a simplified sequential flash operating mode with a raised power button inside the case to activate the sequence instantly for quick deployment. This provides a 'flow' effect of light as each Pod flashes in turn, ideal for use on faster roads where a greater distance is needed between light units.



Run times for light modes:

Rotate	9hrs	Quad Flash	9hrs
Single Blink	60hrs	Alternating Blinks	9hrs
SOS Rescue	14hrs	Steady on High	5hrs
Steady on Low	35hrs	2 LED Lights	28hrs
4 LED Lights	18hrs	White Torch Mode	8hrs
Sequential	15hrs		

RECHARGEABLE LITHIUM BATTERY	IP67 RATING	CHARGING TIME 10HRS	DIMENSIONS 24mm x110mm Diameter	270g
------------------------------	-------------	---------------------	---------------------------------	------

PRODUCT CODE:	MILLICANDELA (MDC)
NSPULSARPROSQ-B:	Blue 6,000
NSPULSARPROSQ-G:	Green 11,000
NSPULSARPROSQ-R:	Red 7,000
NSPULSARPROSQ-Y:	Yellow 7,500

Supplied with: Charging base, charging cable, car charger

- Ideal for road side hazards, traffic control, signalling, hazard awareness and vehicle safety. Emergency Responders, Police, Fire and Highway Services.

OPTIONAL ACCESSORIES:



Single Pulsar-AAA LED Hazard Warning Lights

The PULSAR-AAA is a multi-mode LED warning light within a shockproof housing, able to withstand crushing by weights of up to a tonne. These compact lights are designed for hazard awareness or signalling. They are extremely robust & waterproof, as well as being magnetic, so they can be attached to vehicles or other steel surfaces. Capable of operating for up to 25 hours dependant on chosen mode.



Run times for light modes:

Rotate	8hrs	Quad Flash	8hrs
Single Blink	25hrs	Alternating Blinks	8hrs
SOS Rescue	12hrs	Steady on High	7hrs
Steady on Low	20hrs	2 LED Lights	25hrs
4 LED Lights	18hrs	White Torch Mode	20hrs

3XAAA BATTERIES	IP67 RATING	DIMENSIONS 34mm x110mm Diameter	170g	3 YEAR WARRANTY
-----------------	-------------	---------------------------------	------	-----------------

PRODUCT CODE:	MILLICANDELA (MDC)
NSPULSARAAA-B:	Blue 6,000
NSPULSARAAA-G:	Green 11,000
NSPULSARAAA-R:	Red 7,000
NSPULSARAAA-Y:	Yellow 7,500

Supplied with: 3 x AAA batteries
Optional accessories: Cone Mount: SPPULSARMAG



[Video Link](#)



**Recharges In The Day
and Lights Up At Night**

**Ideal For Remote Locations
Where There Is No
Electricity Supply**



**Environmentally Friendly
= 100% Energy Saving**



IDEAL FOR:

- Bike/Bus Shelters
- Shed and Garages
- Car Port Lighting
- Outdoor Kiosks
- Walkways

NEW Solar Sentry 1200RC and 2400RC

Rechargeable Solar Powered LED Linear Lights

The new rechargeable Solar Sentry linear light is available in two light output: 1200 or 2400 lumens. With up to 5 metre flood beam and a 120° angle. The light is powered by a separate solar panel that charges lithium-ion battery directly from the sunlight in just 6 hours, with up to 12 hours of running time. It features an 8 metre PIR motion detector that lights up for 1 minute when motion has been detected. Absolutely no running costs! Designed to be easy to install, and no wiring is required.

2 MODELS AVAILABLE:

SOLAR SENTRY 1200RC
10W Monocrystalline Solar Panel



SOLAR SENTRY 2400RC
18W Monocrystalline Solar Panel



OR



LIGHT OUTPUT	UP TO 12hrs	3 METRES
RECHARGEABLE LITHIUM BATTERY	IP65 RATING	CHARGING TIME 6HRS
DIMENSIONS 60mm x80mm x360mm	DIMENSIONS 60mm x80mm x360mm	
2kg		

PRODUCT CODE: NSSOLARSENTRY1200RC

LIGHT OUTPUT	UP TO 12hrs	5 METRES
RECHARGEABLE LITHIUM BATTERY	IP65 RATING	CHARGING TIME 6HRS
DIMENSIONS 60mm x80mm x600mm	DIMENSIONS 60mm x80mm x600mm	
2.8kg		

PRODUCT CODE: NSSOLARSENTRY2400RC

KEY FEATURES:

- Solar Powered
- Rechargeable lithium battery (3.7V 12Ah)
- Easy installation - No wiring
- Monocrystalline Solar Panel
- 120° Beam angle
- 8 Metre PIR detection range - Lights up for 1 minute when activated
- Efficient solar panel - Fully Recharges in 6 hours
- Robust housing
- No running costs - 100% Energy savings
- Supplied with a 5 metre cable, Remote control and wall switch



CONNECTIONS:

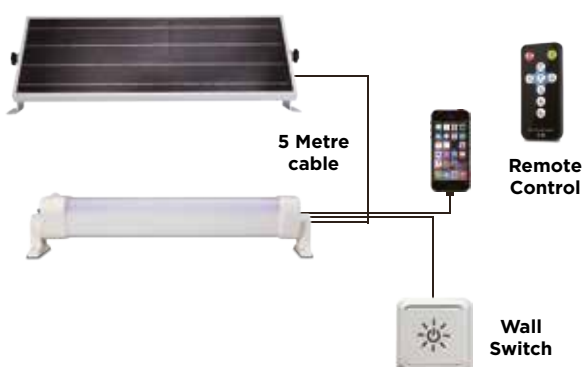

NEW Solar Panel - Recharge Products on the go

Rechargeable Foldable 48W Solar Panel

The new flexible solar charging panel has a 8.4V, 16.8V DC + USB 5 outlets, that easy folds from 4 to one panel for maximum portability. Perfect for your when your searchlight or floodlight needs a quick recharge.



Foldable design



8.4V + 16.8V DC + USB 5

KEY FEATURES:

- 19.8% Highly efficient Monocrystalline Solar Cell
- 48W Solar Panel
- Designed to be portable and withstand outdoor environment
- Excellent low light capabilities
- Working temperature -20° to 70°C
- Foldable design
- IP65 Water resistant
- Dual Recharging Outlets:
- Foldable size: 306mm x 309mm
- Open size: 1197mm x 309 x 3mm

ETFE Lamination increases light absorption by 5%

Mono C-si Solar cells with 20% conversion efficiency

Double Layers of EVA ensure the long life-span

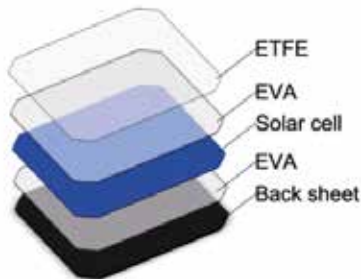

PRODUCT CODE: SPSOLARPANEL



Environmentally Friendly = 100% Energy Saving

COMPATIBLE NIGHTSEARCHER PRODUCTS:



ProStar & ProStar Lite Searchlight P36



Panther XHP Searchlight P39



Solaris Pro and Solaris Pro-X Floodlight P6



Solaris Duo 40K Floodlight P8

Solar Sentry-400

400 Lumens, Rechargeable Solar Powered LED Security Light

The Solar Sentry-400 solar power security light is perfect for adding additional security around the home as well as office buildings and warehouses, and providing lighting to pathways, gardens and driveways. Absolutely no running costs! Designed to be easy to install, and no wiring is required.



KEY FEATURES:

- Solar Powered
- Powerful 400 Lumens
- Runs up to 50 hours
- 8 Metre flood Light beam
- Rechargeable lithium battery (3.7V 2200mAh)
- Easy installation - No wiring
- Day & night auto sensors
- 8 Metre PIR detection range - Lights up for 30 seconds when activated
- Efficient solar panel - Fully Recharges in 6-8 hours
- Robust housing
- No running costs - 100% Energy savings
- Perfect for around the home, giving lighting to driveways and adding security.



Recharges from the Sun,
no need for AC mains



Environmentally Friendly
= 100% Energy Saving



400
LUMENS



UP TO
50hrs



PRODUCT CODE: NSSOLARSENTRY400
CAT/PAD: 0111/114275

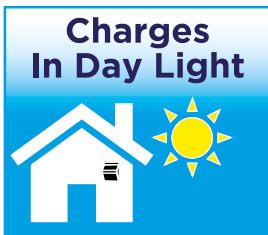

Day + Night
Auto Sensor

Choose a Light Mode



1 MOTION
ACTIVATION

High Light
When
Movement
Is Detected



2 LOW LIGHT
ON AT NIGHT

High Light
When
Movement
Is Detected



3 LIGHT ALWAYS
ON AT NIGHT

Solar Sentry-1000

1000 Lumens, Rechargeable Solar Powered LED Security Light

The Solar Sentry-1000 solar power security light is perfect for adding additional security around the home sheds and garages, providing lighting to driveways. It recharges from the sun, no AC required and takes just minutes to install. The light is supplied with a 2.5m cable for connecting the solar panel to the light.



Charges from Sun,
no need for AC mains

PIR Adjustable Motion Sensor Controls:

TIME



Lighting Time:
3 Sec. -
7 Minutes

LUX



Night -
Day Light
Sensor

SENS



Distance
Sensitivity
0 - 12 Metre

KEY FEATURES:

- Solar Powered
- Powerful 1000 Lumens
- Runs up to 10 hours
- Rechargeable lithium battery (7.4V 18000mAh)
- Easy installation - No wires
- 15 Metre flood Light beam
- 12 Metre PIR detection range -
Lights up for 3 seconds to 7 minutes when activated
- Day & night auto sensors
- Efficient solar panel - Fully Recharges in 8-10 hours
- No running costs - 100% Energy savings
- Perfect for around the home, giving lighting to driveways and adding security.
- Supplied with 2.5 metre cable



Day + Night
Auto Sensor



1000
LUMENS

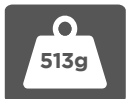

PRODUCT CODE: NSSOLARSENTRY1000
CAT/PAD: 0111/110180



Environmentally Friendly
= 100% Energy Saving



Supplied in a counter top display

Solar Sentry-1100RC

1100 Lumens, Rechargeable Solar Powered LED Security Light

The Solar Sentry-1100RC motion sensor security light is a great addition for around the home and workplace, providing extra lighting to yards, driveways, and gardens, and adding security for peace of mind. The remote control makes it easy to control the five light modes. It features a PIR motion detector that picks up movement from up to 8 metres, and there are absolutely no running costs! Designed to be easy to install, and no wiring is required.



Remote Control
5 Light Modes

Charges from sun,
no need for AC mains



Day + Night
Auto Sensor

KEY FEATURES:

- Solar Powered
- Powerful 1100 Lumens
- Runs up to 8 hours
- Rechargeable lithium battery (3.7V 7800mAh)
- Easy installation - No wires
- 20 Metre flood beam
- 8 Metre sensor detection - Lights up for 30 seconds when activated
- Day & night auto sensors
- Battery charging indicator
- Efficient solar panel - Fully Recharges in 6-8 hours
- No running costs - 100% Energy savings
- Perfect for around the home, giving lighting to driveways and adding security.

DAY MODE

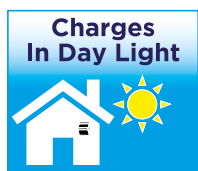

Choose a
Night Mode



3 LIGHT ALWAYS
ON AT NIGHT

Low Light On
All Night,
Turn Off
At Daytime

FIVE NIGHT MODES



1 MOTION
ACTIVATION

Low Light On,
High Light When
Movement
Is Detected



2 POWER
SAVING

No Light On,
High Light When
Movement
Is Detected



4 AUTOMATIC

Lights On When
Charged +60%
Switches To
Mode 2 -60%



5 EMERGENCY

Switch On With
Remote Control
High Light
For 1 hour Only

Environmentally Friendly = 100% Energy Saving



1100
LUMENS



UP TO
8hrs



CHARGING
TIME 6-8HRS

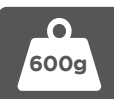

PRODUCT CODE: NSSOLARSENTRY1100RC
CAT/PAD: 0111/114319



DarkStar

Head Torch With Light-Sensor Automatic Light Level Recognition

The DarkStar is a high powered 170 lumen LED head torch with a unique feature: left on standby mode this unit will automatically come on in the dark or switch off in well lit areas - it's even smart enough to adjust the light level based on the surroundings! 7 light modes are available with a long range beam or flood for close up inspections. Ideal for Jogging, Running, Hiking, Camping and Dog Walking so that you can Be Safe and Be Seen!

NightSearcher



KEY FEATURES:

- Powerful 170 Lumens
- Runs up to 24 hours
- Auto mode - On/Off, Dimming, Night sensor
- Light position adjustment
- Emergency light
- Light level auto adjustment
- Ideal for jogging, hiking and walking the dog
- Supplied with Head Band, 3 x AAA Batteries

OUTDOOR LIGHTS



	HIGH	LOW
LIGHT OUTPUT	170 LUMENS	85 LUMENS
Beam	2.5hrs	24hrs
RUN TIMES	65 METRES	30 METRES
3x AAA BATTERIES	IPX4 RATING	DIMENSIONS 39mm x63mm x451mm
		136.5 g

PRODUCT CODE: NSDARKSTAR

**BE SAFE
BE SEEN**

**3
YEAR
WARRANTY**



Run Smart

High Visibility LED Sports Head Torch

Run Smart is a compact, soft, lightweight head torch that can be worn either as a headband or around the neck. A perfect addition if you run, jog or take the dog for a walk at night. This award winning product will help you do so safely and efficiently by providing a directed LED light that illuminates the ground in front of you, and a red flashing LED rear light, ensuring you are seen and safe.



KEY FEATURES:

- Powerful 40 Lumens
- Runs up to 100 hours
- 5 Light modes: Front Light (High/Low), Rear Light (flashing), Front (High) and Rear Red light (flashing)
- Adjustable head strap
- Red rear warning lights
- Providing a directed light that illuminates the ground in front
- Ideal for jogging, running and walking the dog
- Supplied with 1 x AAA battery

Light and compact design.
Can be worn as a headband
or around neck.

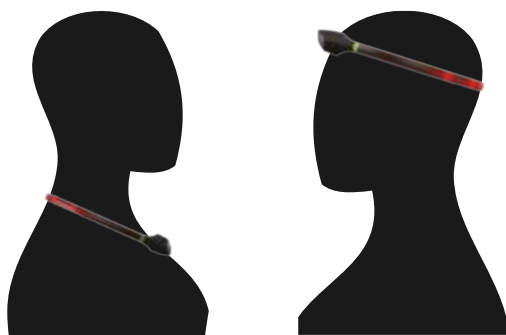

Soft, flexible silicone strap.
Front LED light
and rear flashing LED lights.

	HIGH	LOW	RED FLASHING	RED FLASHING
LIGHT OUTPUT	40 LUMENS	20 LUMENS	8Hz	40Lm 8Hz
Beam	1hr 30 MINS	2hrs 30 MINS	100hrs	1hr
RUN TIMES	6 METRES	3 METRES		
1 x AAA BATTERIES	IPX4 RATING	DIMENSIONS 153mm x164mm 169mm		69g

PRODUCT CODE: NSRUNSMART



reddot design award
winner 2016





UK

Unit 4, Applied House, Fitzherbert Spur,
Farlington, Hampshire, PO6 1TT, UK
023 9238 9774
www.nightsearcher.co.uk

@nightsearcher-limited



EUROPE

Garbary 53, Poznan
Poland
+44 239 216 1126
www.nightsearcher.com

nightsearcher-limited



HONG KONG

Suite 2512, Langham Place Tower Office
8 Argyle Street, Mongkok Kowloon, Hong Kong
nightsearcher.hk

@NightSearcher



@NightSearcherLtd



Nightsearcher Limited is registered in England.
The Company Registration Number is 4661749.

Like what you see?

Talk to us about becoming a distributor
distributor@nightsearcher.co.uk



SOCOTEC registered
certification to
ISO 9001:2015.



All new products are
designed to minimise
our impact on the
environment.



NightSearcher began manufacturing
lighting systems in 1989 and have
continued producing these from our
UK head office in Portsmouth, UK